



## ASIA

### Rocsta

Rocsta	7/1993 on		<b>N1389</b>	260.0 x 45.0
--------	-----------	--	--------------	--------------

**N1389**

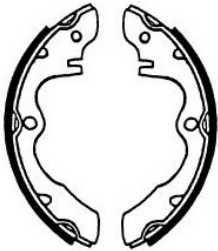

260.0 x 45.0

## AUDI

### 80

80 & 90 Series Sedan	1967 - 70		<b>N1460</b>	200.0 x 42.0
FOX 80 Sedan with Manual Trans	1974		<b>N1508</b>	180.0 x 30.0
80L, LS, GL	1974 - 78		<b>N1508</b>	180.0 x 30.0

### 100

LS Sedan	1970 - 71		<b>N1460</b>	200.0 x 42.0
LS Sedan	1972 - 73		<b>N1506</b>	200.0 x 42.0
GL Sedan	1974 - 76		<b>N1506</b>	200.0 x 42.0
5E GL, CD & EXEC Sedan	1978 - 79		<b>N1507</b>	230.0 x 39.0

**N1460**



200.0 x 42.0

**N1506**



200.0 x 42.0

**N1507**

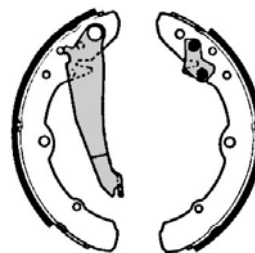

230.0 x 39.0

**N1508**



180.0 x 30.0



## AUSTIN

### 1100

1100	1963			<b>N1232</b>	203.2 x 31.7
1100	1969 on			<b>N1324</b>	203.2 x 31.7

### 1800

Ute	1970 - 73			<b>N1164</b>	228.6 x 38.1
-----	-----------	--	--	--------------	--------------

### A Series

A30	1952 - 58	<b>N1000</b>	177.8 x 31.7	<b>N1000</b>	177.8 x 31.7
A90, A95, A105 & Westminster	1954 - 59	<b>N1456</b>	279.4 x 57.1	<b>N1027</b>	279.4 x 57.1
A50, A55	1956 - 59	<b>N1004</b>	228.6 x 44.4	<b>N1002</b>	228.6 x 44.4
A40- FARINA	1959 - 61	<b>N1230</b>	203.2 x 38.1	<b>N1000</b>	177.8 x 31.7
A55 Cambridge & MKII	1959 on	<b>N1145</b>	228.6 x 63.5	<b>N1002</b>	228.6 x 44.4
A60	1961 on	<b>N1145</b>	228.6 x 63.5	<b>N1002</b>	228.6 x 44.4

### Freeway

Freeway	1961 - 65	<b>N1145</b>	228.6 x 63.5	<b>N1002</b>	228.6 x 44.4
---------	-----------	--------------	--------------	--------------	--------------

### Healy

Sprite Drum/Drum	1958 - 63	<b>N1226</b>	177.8 x 31.7	<b>N1227</b>	177.8 x 31.7
3000	1959 - 67			<b>N1027</b>	279.4 x 57.1
Sprite Disc/Drum	1963 - 67			<b>N1332</b>	177.8 x 31.7

### Lancer

Series I & II	1958 - 62	<b>N1234</b>	228.6 x 38.1	<b>N1230</b>	203.2 x 38.1
---------------	-----------	--------------	--------------	--------------	--------------

### Mini

Van 850	1962 - 67	<b>N1332</b>	177.8 x 31.7	<b>N1332</b>	177.8 x 31.7
1800 Ute	1970 - 73			<b>N1164</b>	228.6 x 38.1

### Nomad

1800 MK1	1964 - 69			<b>N1002</b>	228.6 x 44.4
1300, 1300S & 1500	1969 on			<b>N1324</b>	203.2 x 31.7
1800 MK11	1969 - 73			<b>N1164</b>	228.6 x 38.1

### XK Kimberley

Tasman	1970 - 73			<b>N1164</b>	228.6 x 38.1
--------	-----------	--	--	--------------	--------------

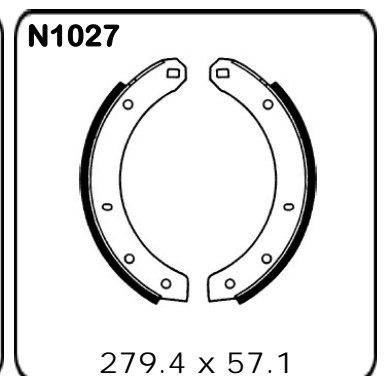
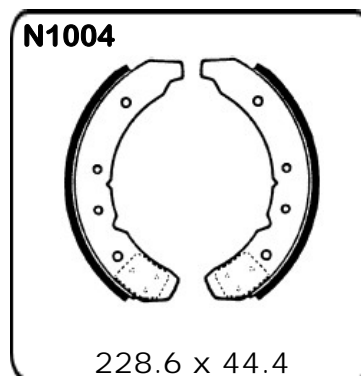
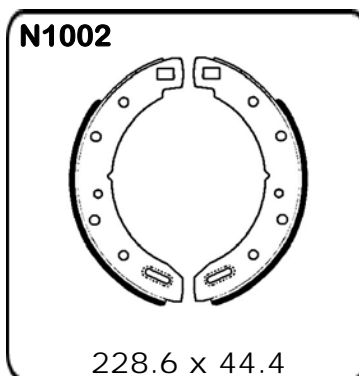
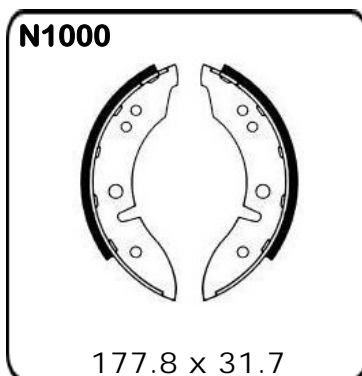



## AUSTIN

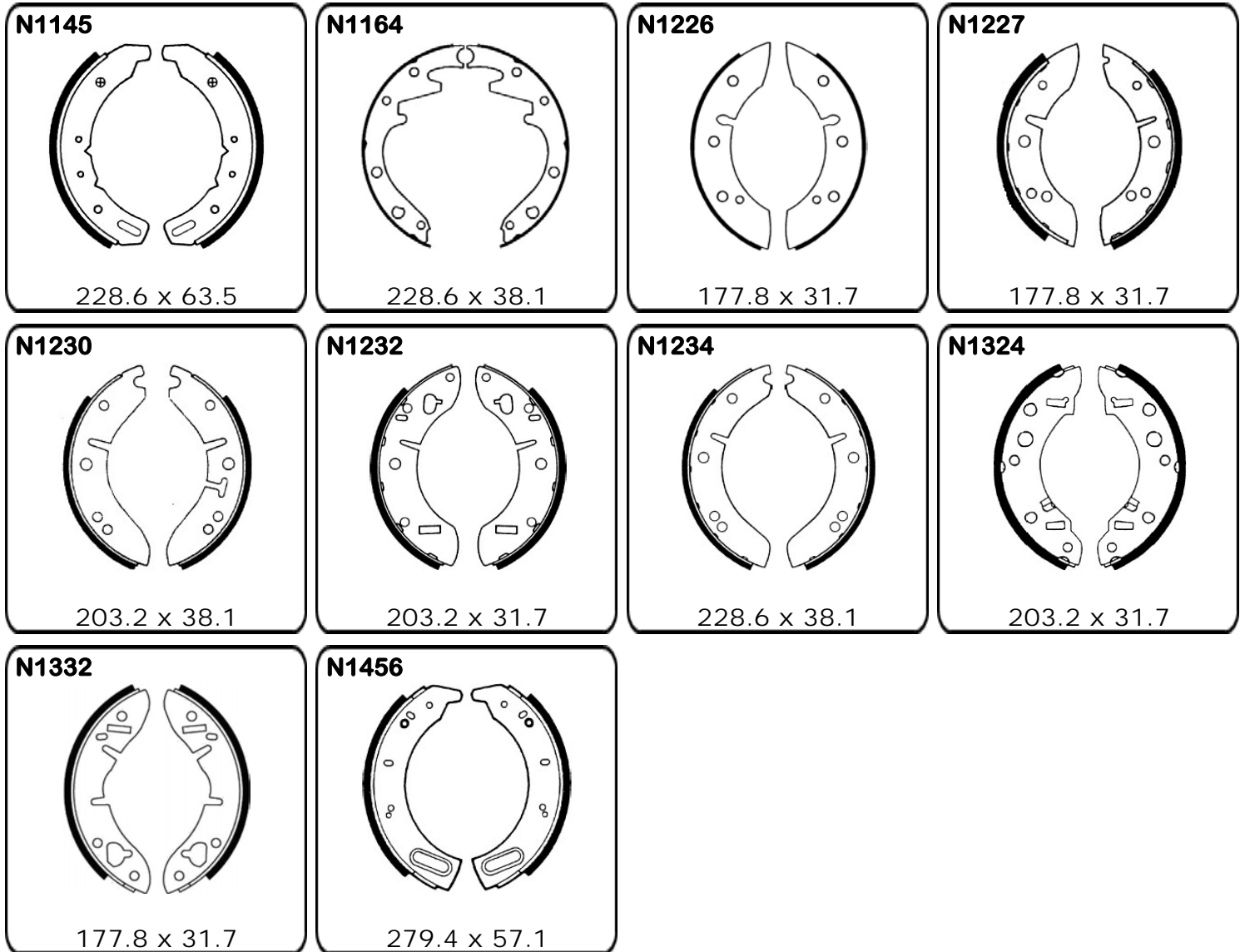

## BEDFORD

### CF Series

CFS900 1100KG Van	1970 - 77	<b>N1037</b>	228.6 x 69.8	<b>N1036</b>	228.6 x 44.4
CFL 1750KG Van	1973 - 80	<b>N1035</b>	254.0 x 69.8	<b>N1031</b>	254.0 x 69.8



## BEDFORD

### CF Series

CFS900 1300KG Van	1977 - 79	<b>N1035</b>	254.0 x 69.8	<b>N1459</b>	254.0 x 57.1
-------------------	-----------	--------------	--------------	--------------	--------------

### Van

FJ Van - Holden 6 Cyl	1978 on	<b>N1035</b>	254.0 x 69.8	<b>N1459</b>	254.0 x 57.1
-----------------------	---------	--------------	--------------	--------------	--------------

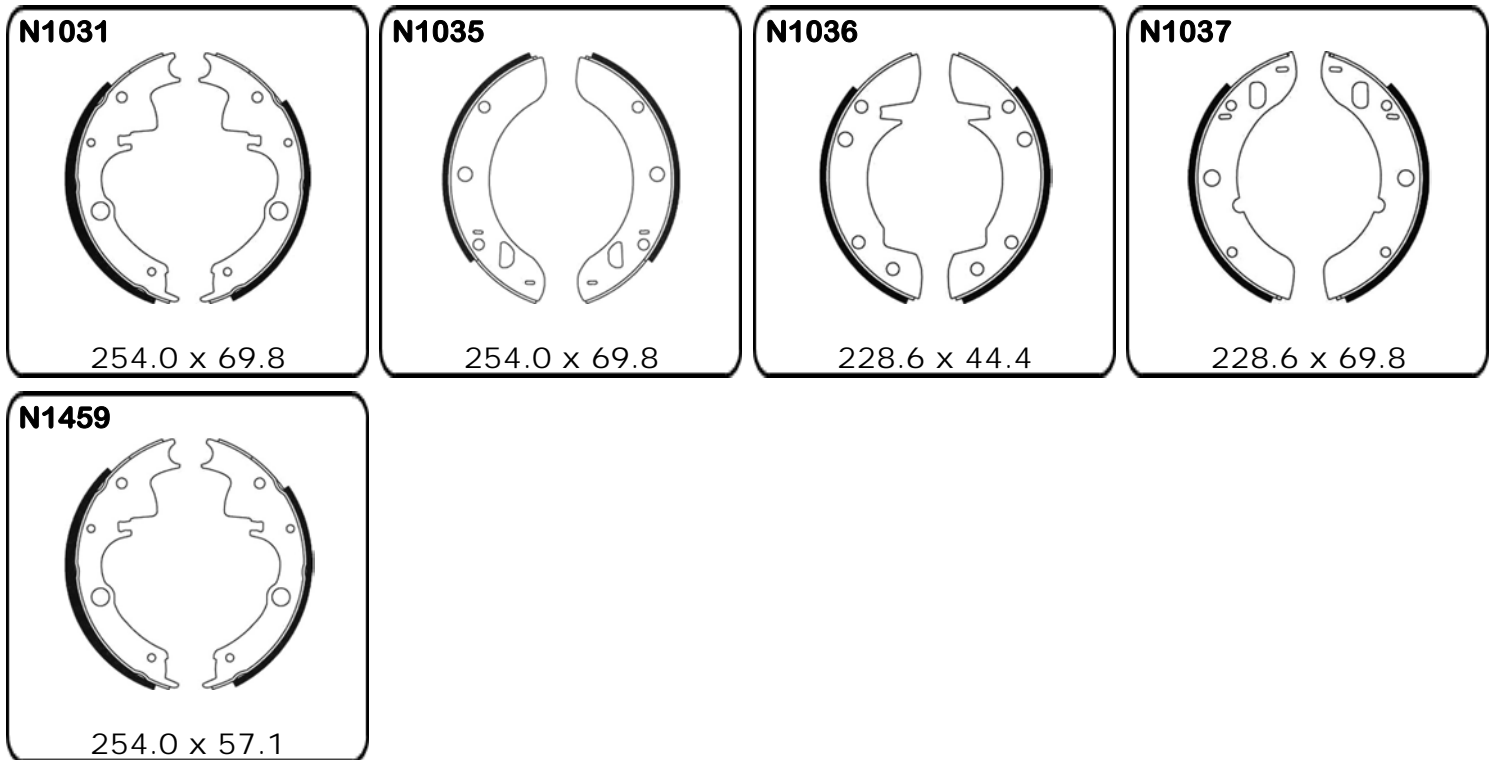

## BMW

### 3 Series

316, 318, 318i, 320, 320i	7/1975 - 79			<b>N1461</b>	250.0 x 42.0
160mm E21 & E30	6/1975 - 10/94		<b>Handbrake</b>	<b>N3016</b>	160.0 x 25.0
316, 318, 318i, 320, 320i	1979 - 83			<b>N1461</b>	250.0 x 42.0
318i	1983 - 84			<b>N1354-1</b>	228.6 x 40.0
180mm E36	9/1990 - 9/99		<b>Handbrake</b>	<b>N3017</b>	180.0 x 25.0
316i, 318i E36	90 - 98			<b>N3212</b>	228.6 x 42.0
323 2.5L & 328 2.8L	1995 - 97		<b>Handbrake</b>	<b>N3084</b>	160.0 x 25.0





## BMW

### 5 Series

518, 520 & 520i	1973 - 76			<b>N1461</b>	250.0 x 42.0
160mm E12	9/1976 - 3/81		<b>Handbrake</b>	<b>N3016</b>	160.0 x 25.0
518, 520 6 Cyl, 520 & 520i	1977 - 7/78			<b>N1461</b>	250.0 x 42.0
518, 520 6 Cyl, 520 & 520i	8/1978 - 7/81			<b>N1461</b>	250.0 x 42.0
518i, 520i	8/1981 - 88			<b>N1461-1</b>	250.0 x 42.0
180mm E28, 34	4/1981 - 1/97		<b>Handbrake</b>	<b>N3017</b>	180.0 x 25.0

### 6 Series

180mm 6 Series E24	10/75 - 10/89		<b>Handbrake</b>	<b>N3017</b>	180.0 x 25.0
160mm 628CSi, 630CS, 633CSi	8/79 - 5/82		<b>Handbrake</b>	<b>N3016</b>	160.0 x 25.0

### 7 Series

180mm 6 Series E24	10/75 - 10/89		<b>Handbrake</b>	<b>N3017</b>	180.0 x 25.0
160mm 628CSi, 630CS, 633CSi	8/79 - 5/82		<b>Handbrake</b>	<b>N3016</b>	160.0 x 25.0

### 1600 Series

Sedan	1967 - 69			<b>N1460</b>	200.0 x 42.0
1600-2 Sedan	1969 - 71			<b>N1460</b>	200.0 x 42.0
1602 Sedan	1971 - 73			<b>N1460</b>	200.0 x 42.0

### 1800 Series

Sedan	1967 - 68			<b>N1461</b>	250.0 x 42.0
Sedan	1969 - 70			<b>N1461</b>	250.0 x 42.0

### 2000 Series

Sedan	1967 - 68			<b>N1461</b>	250.0 x 42.0
Sedan	1969 - 70			<b>N1461</b>	250.0 x 42.0

### 2002 Series

Sedan	1968 - 69			<b>N1460</b>	200.0 x 42.0
Sedan	1969 - 76			<b>N1462</b>	230.0 x 42.0
Tii Sedan	1973 - 76			<b>N1461</b>	250.0 x 42.0

### Z3

Coupe 2.8L	1/1997 on		<b>Handbrake</b>	<b>N3084</b>	160.0 x 25.0
------------	-----------	--	------------------	--------------	--------------

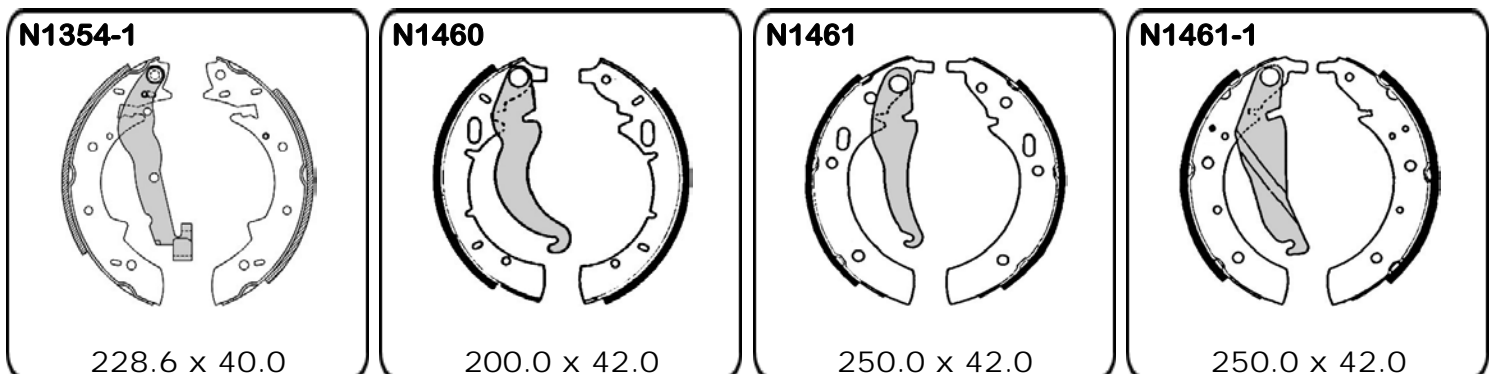



## BMW

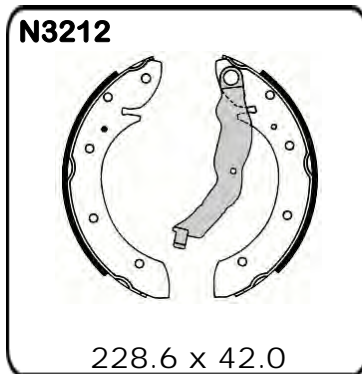
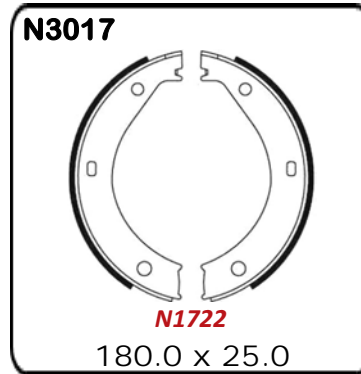
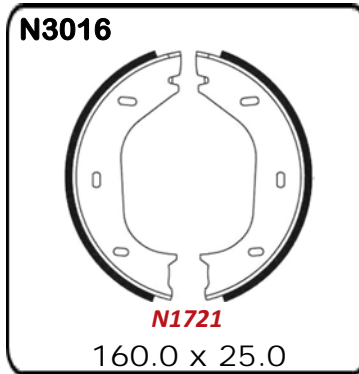
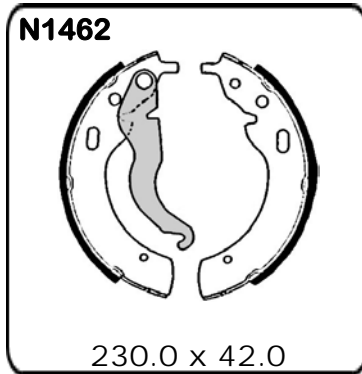

## BUICK

### *Electra*

With front Disc or drum	1969 - 71		<b>N1511</b>	304.8 x 50.8
-------------------------	-----------	--	--------------	--------------

### *Riviera*

With front Disc or drum	1969 - 71		<b>N1511</b>	304.8 x 50.8
-------------------------	-----------	--	--------------	--------------



## BUICK

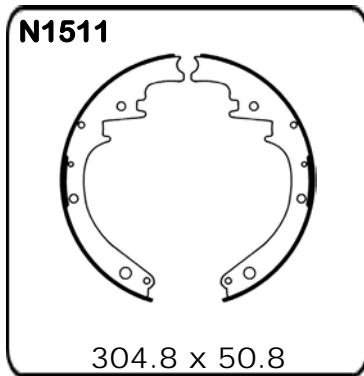

## CHEVROLET

<b>Bel Air</b>					
With front Disc or drum brakes	1969 - 71	<b>N1063</b>	279.4 x 69.8	<b>N1064</b>	279.4 x 50.8
<b>Blazer</b>					
S-10, T-10 2WD & 4WD Handbrake	97 - 04			<b>Minor</b>	PBK216
<b>C20 / C2500</b>					
2WD & 4WD	1976 - 77			<b>N1513</b>	283.3 x 69.8
C1500, C2500 2WD & 4WD With 13" rear brakes	1976 - 02			<b>N3172</b>	330.2 x 63.5
<b>C30 / C3500</b>					
C3500 With 13" drums & 2.1/4" wide shoes	1976 - 02			<b>N3172</b>	330.2 x 63.5
C3500 With 13" Drums & 3.1/2" wide shoes	1976 - 02			<b>N3173</b>	330.2 x 89.0
<b>Camero</b>					
With front Disc or drum brakes	1967 - 81			<b>N1512</b>	241.0 x 50.8
<b>Impala</b>					
With front Disc or drum brakes	1969 - 71	<b>N1063</b>	279.4 x 69.8	<b>N1064</b>	279.4 x 50.8
<b>LUV</b>					
With front drum brakes	1972 - 76	<b>N1365</b>	254.0 x 50.8	<b>N1366</b>	254.0 x 44.4
With front disc brakes	1976 - 80			<b>N1366</b>	254.0 x 44.4
<b>Nova</b>					
Disc/Drum	1985 - 87			<b>N1602</b>	200.0 x 30.0
SOHC	1988			<b>N1602</b>	200.0 x 30.0



## CHEVROLET

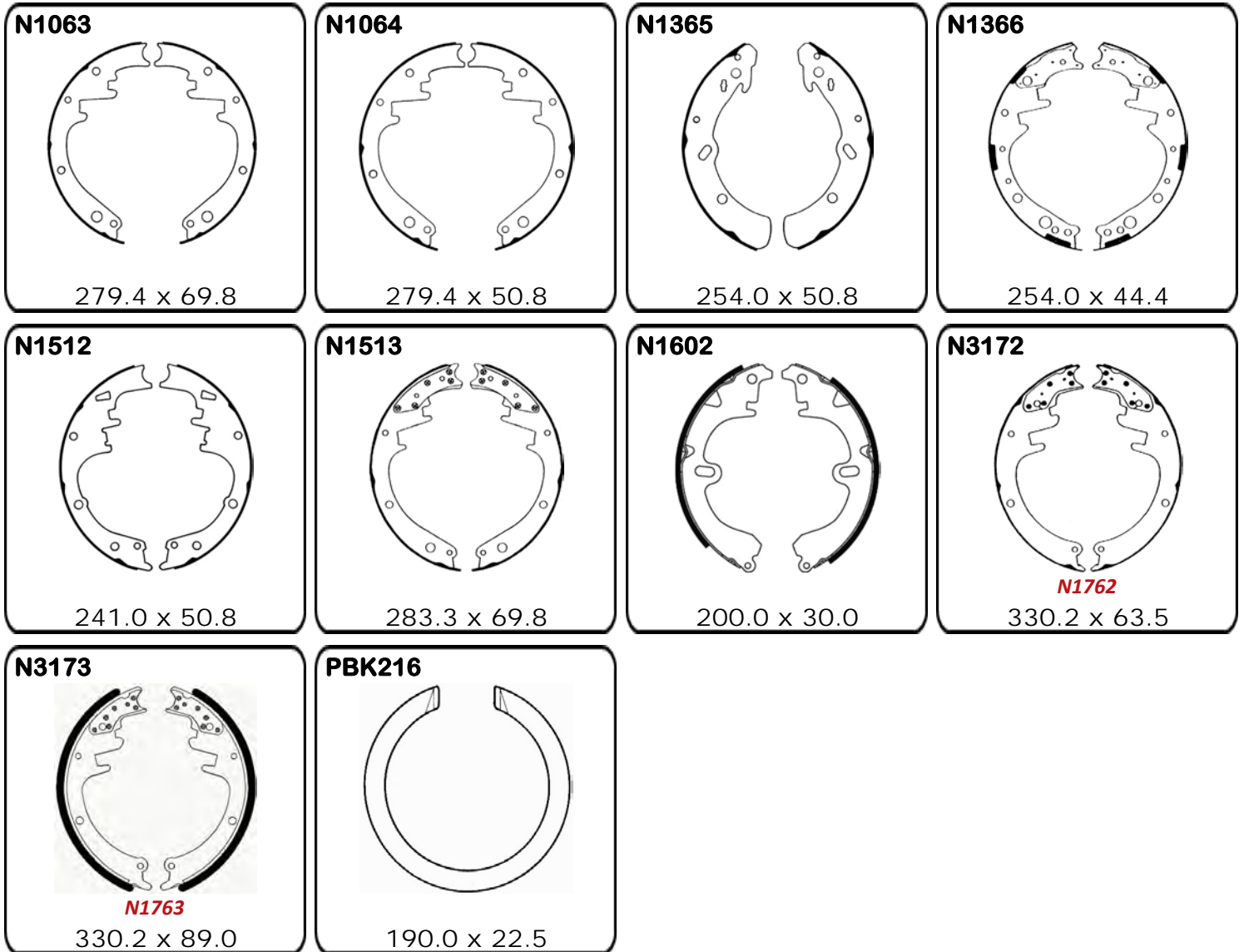

## CHRYSLER

### Centura

KB Series 4 Cyl	1975 - 77		<b>N1370</b>	228.6 x 40.0
KB, KC Series 6 Cyl	1976 on		<b>N1356</b>	228.6 x 38.1



## CHRYSLER

### Crossfire

3.2L & SRT-6 Handbrake	2004 on		<b>Handbrake</b>	<b>N3023</b>	164.0 x 20.0
------------------------	---------	--	------------------	--------------	--------------

### Neon

Neon	1996 - 99			<b>N3012</b>	200.0 x 34.0
------	-----------	--	--	--------------	--------------

### Valiant

Drum/Drum Models	1962 - 75	<b>N1263</b>	228.6 x 63.5	<b>N1264</b>	228.6 x 50.8
CE, VE Series	1967 - 69			<b>N1264</b>	228.6 x 50.8
VG, VH, CH Series	1970 - 73			<b>N1264</b>	228.6 x 50.8
VJ, VK, CJ, CK Series	1973 - 76			<b>N1264</b>	228.6 x 50.8
VK, CK With heavy duty rear brakes	1975 - 76			<b>N1380</b>	254.0 x 50.8
CL, CM Series	12/1976 on			<b>N1380</b>	254.0 x 50.8
CL, CM With PBR Front Brakes	12/1976 on			<b>N1380</b>	254.0 x 50.8

### Voyager

Voyager	1997 on			<b>N3166</b>	250.0 x 55.0
---------	---------	--	--	--------------	--------------

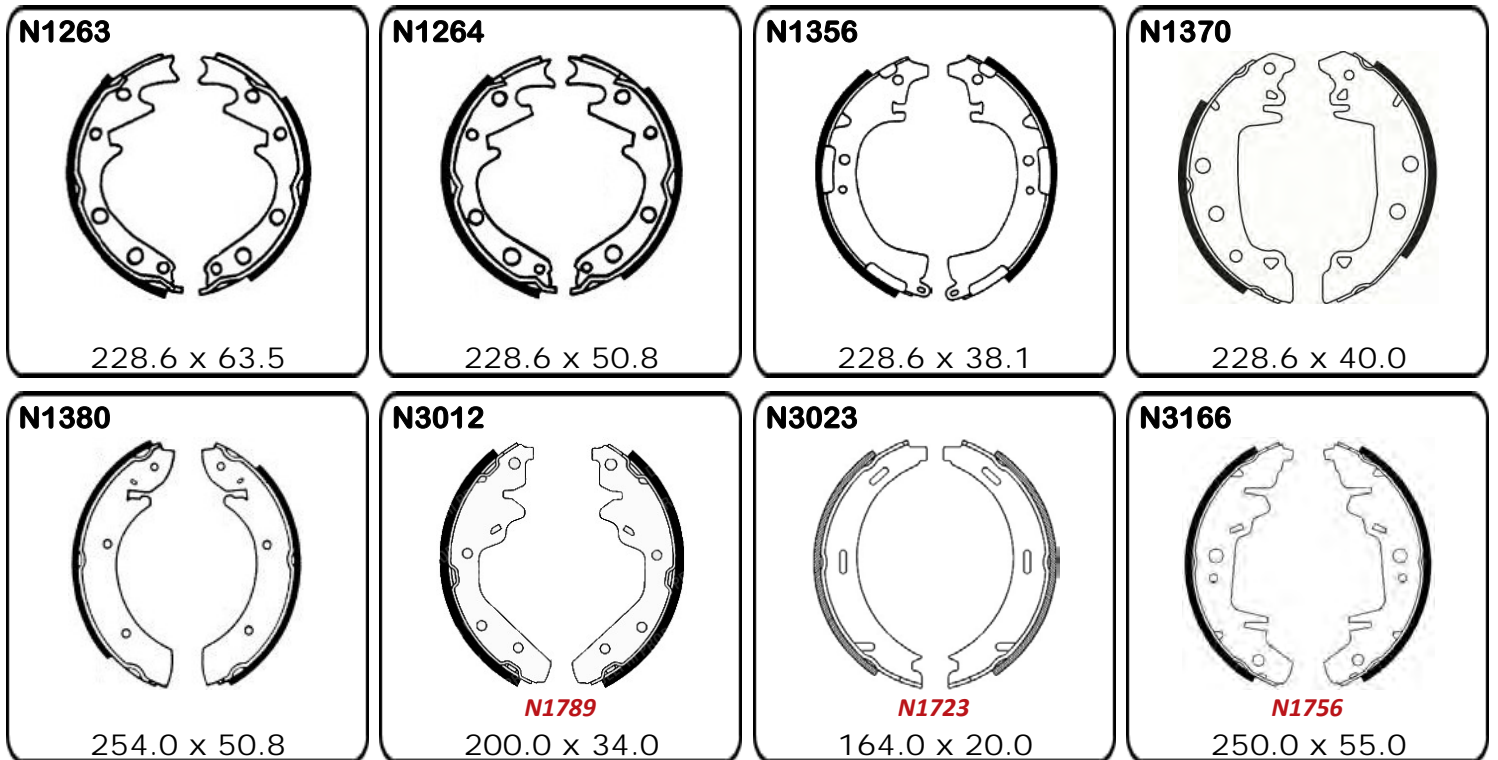



## CITROEN

### AX

10, 10E, 11, 14, 14D, 15D	9/86 - 12/97			<b>N3085</b>	165.0 x 32.0
---------------------------	--------------	--	--	--------------	--------------

### Berlingo

Van	7/1996 on			<b>N3020</b>	228.6 x 42.0
-----	-----------	--	--	--------------	--------------

### Xsara

1.6, 1.8, 2.0 with Lucas Rear brakes	1998 - 03			<b>N3018</b>	180.0 x 30.0
1.6, 1.8, 2.0 with Bendix Rear brakes	1998 - 03			<b>N3019</b>	180.0 x 32.0
Pieasso	2000 on			<b>N3020</b>	228.6 x 42.0

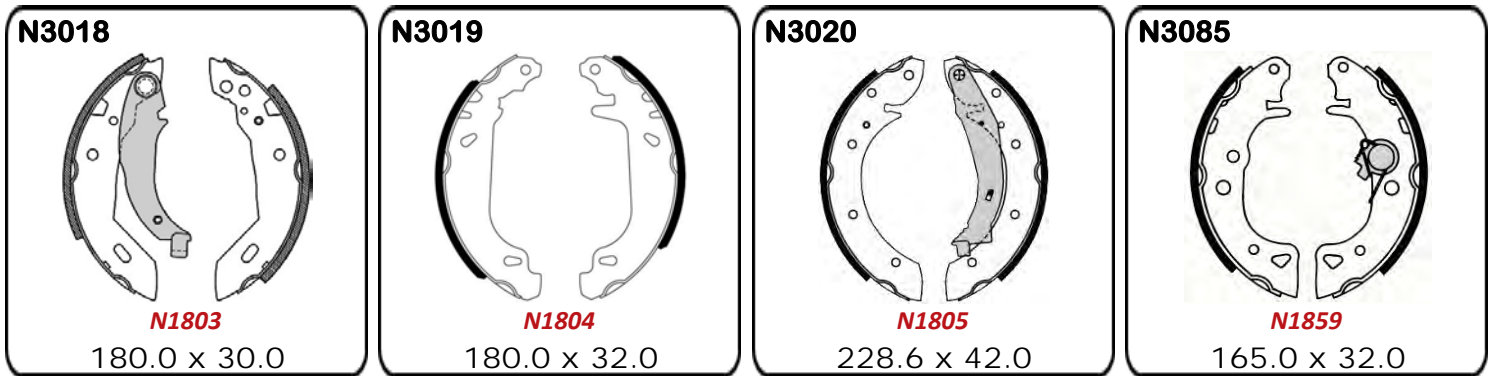

## COMMER

### 1500 Series

Series I & II 740Kg, VT & VH Models	1961 - 63	<b>N1285</b>	254.0 x 57.1	<b>N1285</b>	254.0 x 57.1
-------------------------------------	-----------	--------------	--------------	--------------	--------------

### 2500 Series

VT & VH Petrol or Diesel	1962 - 64	<b>N1285</b>	254.0 x 57.1	<b>N1285</b>	254.0 x 57.1
--------------------------	-----------	--------------	--------------	--------------	--------------

### COB Series

Series I, II & III	1959 - 63	<b>N1230</b>	203.2 x 38.1	<b>N1230</b>	203.2 x 38.1
--------------------	-----------	--------------	--------------	--------------	--------------

### Express Delivery Van

Mark III & VI	1949 - 53	<b>N1230</b>	203.2 x 38.1	<b>N1230</b>	203.2 x 38.1
---------------	-----------	--------------	--------------	--------------	--------------





## COMMER

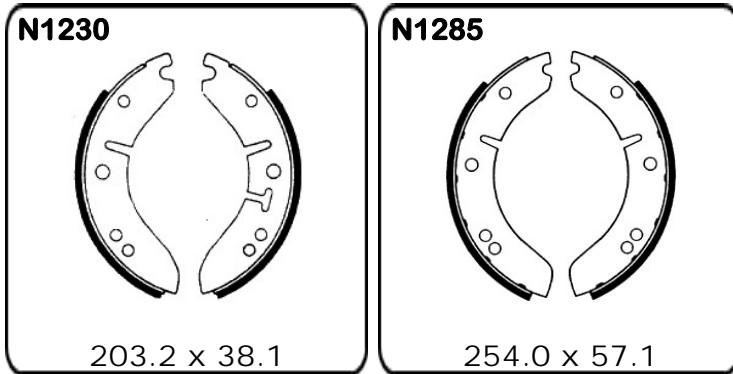

## DAEWOO

<b>Cielo</b>						
1.5L Sedan & Hatch	10/1994 on			<b>N3128</b>	200.0 x 45.0	
<b>Espero</b>						
Espero	3/1995 on			<b>N3128</b>	200.0 x 45.0	
<b>Kalos</b>						
T200	2003 - 05			<b>N3058</b>	200.0 x 36.1	
<b>Lanos</b>						
Sedan, Hatch & Wagon	9/1997 on			<b>N3128</b>	200.0 x 45.0	
<b>Matiz</b>						
Sedan, Hatch & Wagon	10/1999 on			<b>N3006</b>	180.0 x 31.0	
<b>Nubira</b>						
1.6L Sedan & Hatch	6/1997 on			<b>N3128</b>	200.0 x 45.0	
Banksia Park Brake Kit	6/1997 - 6/03	<b>Major</b>	PBK125	<b>Minor</b>	PBK124	
<b>Tacuma</b>						
2.0L	2000 on			<b>N3072</b>	228.6 x 50.0	



## DAEWOO

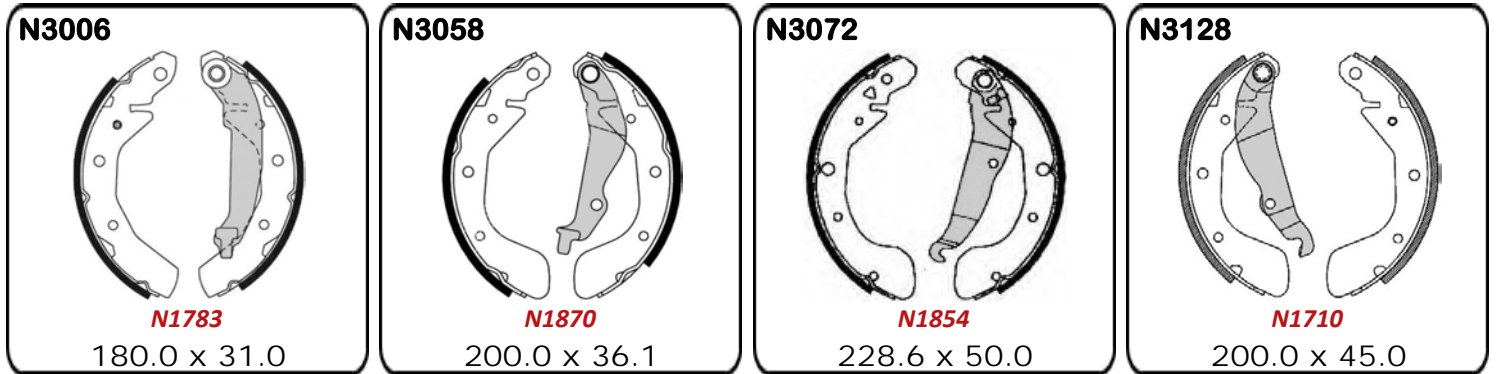

## DAIHATSU

### Applause

A101 1.6L	1990 on			<b>N3101</b>	200.0 x 30.0
-----------	---------	--	--	--------------	--------------

### Centro

3 Door Van	3/1995 on			<b>N1406</b>	180.0 x 35.0
------------	-----------	--	--	--------------	--------------

### Charade

360, 550Kg Van	1972 - 77	<b>N1609</b>	180.0 x 35.0	<b>N1406</b>	180.0 x 35.0
G10, XTX, XG	1978 - 83			<b>N1406</b>	180.0 x 35.0
G11, G21	1984			<b>N1606</b>	180.0 x 30.0
G11, G21	1985			<b>N1632</b>	180.0 x 30.0
G100, G102, 4 Door Sedan Only	1987 on			<b>N3101</b>	200.0 x 30.0
G100, G102, 3 & 5 Door Hatch Only	1987 on			<b>N1658</b>	180.0 x 25.0
G200	6/1993 on			<b>N3101</b>	200.0 x 30.0
G202, G203	1993 on			<b>N1658</b>	180.0 x 25.0
L251S 1.0L	7/03 - 12/05			<b>N1658</b>	180.0 x 25.0

### Copen

L880 0.7L	10/03 - 12/05			<b>N3200</b>	180.0 x 25.0
-----------	---------------	--	--	--------------	--------------

### Cuore

L55, L60	9/1980 on	<b>N1609</b>	180.0 x 35.0	<b>N1406</b>	180.0 x 35.0
----------	-----------	--------------	--------------	--------------	--------------

### Delta

DV23, DV24, DV26, SV23, SV26 2L	1970 - 77	<b>N1583</b>	309.9 x 75.0	<b>N1583</b>	309.9 x 75.0
SV17 1500KG	1972 - 74	<b>N1346</b>	254.0 x 44.8	<b>N1346</b>	254.0 x 44.8
V76, 78, 79, V89, V90, 92, 98, 99 EXCEPT FLAT LOW	9/1974 on	<b>N1544</b>	320.0 x 75.0	<b>N1544</b>	320.0 x 75.0
V76, 89 FLAT LOW BED	9/1974 on	<b>N1544</b>	320.0 x 75.0	<b>N3175</b>	228.6 x 75.0



## DAIHATSU

### Delta

V10, 11, 12, V20, 22, 23, 24, 25, V30, 31, 32, 34	1978 - 84	<b>N1544</b>	320.0 x 75.0	<b>N1544</b>	320.0 x 75.0
V57 Drum/Drum	1978 on	<b>N1494</b>	290.0 x 60.0	<b>N1494</b>	290.0 x 60.0
V57 Disc/Drum	1978 on			<b>N1494</b>	290.0 x 60.0
V35, 36, V47, 48, V50, 52, 54, 55	1978 - 84	<b>N3175</b>	228.6 x 75.0	<b>N3175</b>	228.6 x 75.0
V10, 11, 12, V20, 22, 23, 24, 25, V30, 31, 32, 34	1978 - 84	<b>N3175</b>	228.6 x 75.0	<b>N3175</b>	228.6 x 75.0
V35, 36, V47, 48, V50, 52, 54, 55	1978 - 84	<b>N1494</b>	290.0 x 60.0	<b>N1494</b>	290.0 x 60.0
V10, 11, 12, V20, 22, 23, 24, 25, V30, 31, 32, 34	1978 - 84	<b>N1494</b>	290.0 x 60.0	<b>N1494</b>	290.0 x 60.0
V35, 36, V47, 48, V50, 52, 54, 55	1978 - 84	<b>N1544</b>	320.0 x 75.0	<b>N1544</b>	320.0 x 75.0
V58, 59 EXCEPT FLAT LOW BED	9/84 - 12/96	<b>N1544</b>	320.0 x 75.0	<b>N1544</b>	320.0 x 75.0
V58, 59 FLAT LOW BED	9/84 - 12/96	<b>N1544</b>	320.0 x 75.0	<b>N3175</b>	228.6 x 75.0
V67	9/84 - 12/96	<b>N1494</b>	290.0 x 60.0	<b>N1494</b>	290.0 x 60.0
V107 Disc/Drum	9/84 - 12/96			<b>N1494</b>	290.0 x 60.0
V107 Drum/Drum	9/84 - 12/96	<b>N1494</b>	290.0 x 60.0	<b>N1494</b>	290.0 x 60.0
V108, V116, 118, 119 STD	1984 - 97	<b>N1544</b>	320.0 x 75.0	<b>N1544</b>	320.0 x 75.0
V108, 119 FLAT LOW	1984 - 97	<b>N1544</b>	320.0 x 75.0	<b>N3175</b>	228.6 x 75.0
V68, 69 EXCEPT FLAT LOW BED	To 11/94	<b>N1544</b>	320.0 x 75.0	<b>N1544</b>	320.0 x 75.0
V68, 69 FLAT LOW BED	To 11/94	<b>N1544</b>	320.0 x 75.0	<b>N3175</b>	228.6 x 75.0
Handbrake Most Models			<b>Handbrake</b>	<b>N1543</b>	178.0 x 35.0

### Duet

Van	1983 - 86			<b>N1606</b>	180.0 x 30.0
-----	-----------	--	--	--------------	--------------

### Feroza

4WD	1989 on			<b>N1607</b>	254.0 x 44.0
-----	---------	--	--	--------------	--------------

### Handivan

L38, L40 2 Cyl	1979 - 82	<b>N1609</b>	180.0 x 35.0	<b>N1406</b>	180.0 x 35.0
S75, S76	1981 on			<b>N1608</b>	180.0 x 35.0
LGU, L55, L60	1982 - 86			<b>N1406</b>	180.0 x 35.0
S70 Series 850cc	1984	<b>N1609</b>	180.0 x 35.0	<b>N1406</b>	180.0 x 35.0
L80 RV	1987 on			<b>N1670</b>	165.0 x 25.0

### Hi-Jet

S60, S65 2 Cyl	1978 - 81	<b>N1609</b>	180.0 x 35.0	<b>N1406</b>	180.0 x 35.0
S60, S65, S70 With Front Discs	1980 - 86			<b>N1608</b>	180.0 x 35.0
S70 3 Cyl	1982 - 84	<b>N1609</b>	180.0 x 35.0	<b>N1608</b>	180.0 x 35.0
S75, S76	1984 on			<b>N1608</b>	180.0 x 35.0
S84, S85, S86	1987 on			<b>N1673</b>	180.0 x 35.0
S84, S85, S86 - Jumbo	1987 on			<b>N1608</b>	180.0 x 35.0

### Mira

L200, L201	3/1990 - 2/95			<b>N3107</b>	165.0 x 25.0
L500	3/1995 on			<b>N1670</b>	165.0 x 25.0



## DAIHATSU

### Move

5 Door	2/1997 on			<b>N3107</b>	165.0 x 25.0
--------	-----------	--	--	--------------	--------------

### Pyzar

Pyzar	2/1997 on			<b>N3165</b>	200.0 x 35.0
-------	-----------	--	--	--------------	--------------

### Rocky

4WD F70, F75, F80, F85	1984 - 90			<b>N1607</b>	254.0 x 44.0
4WD F77 Sportswagon	1990 on			<b>N1607</b>	254.0 x 44.0

### Scat

F10, F20, F50 4WD	1974 - 81	<b>N1407</b>	254.0 x 45.0	<b>N1407</b>	254.0 x 45.0
F10, F20, F50 4WD	1974 - 81		<b>Handbrake</b>	<b>N1542</b>	160.0 x 35.0
F20, F25 4WD	1982 on			<b>N1407</b>	254.0 x 45.0
F50	1984 on	<b>N1407</b>	254.0 x 45.0	<b>N1407</b>	254.0 x 45.0
F50	1984 on		<b>Handbrake</b>	<b>N1638</b>	178.0 x 34.0

### Sirion

1.0L, 1.3L Hatch	7/1998 - 00			<b>N3203</b>	180.0 x 25.0
1.0L, 1.3L Hatch	2000 on			<b>N3200</b>	180.0 x 25.0

### Terios

4WD 1.3L Wagon	7/1997 on			<b>N3160</b>	228.6 x 40.0
----------------	-----------	--	--	--------------	--------------

### YRV

M200/M201	01 - 05			<b>N3200</b>	180.0 x 25.0
-----------	---------	--	--	--------------	--------------

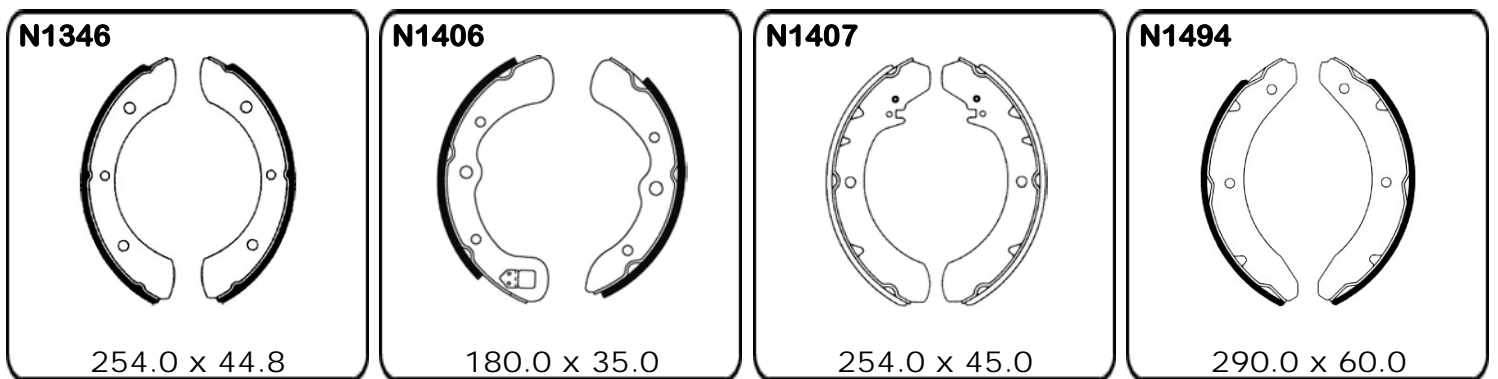



## DAIHATSU

**N1542**

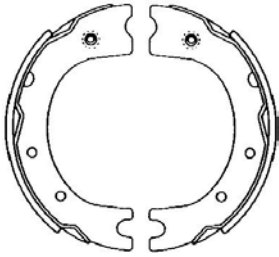

160.0 x 35.0

**N1543**

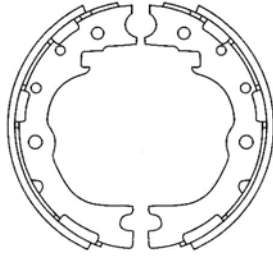

178.0 x 35.0

**N1544**

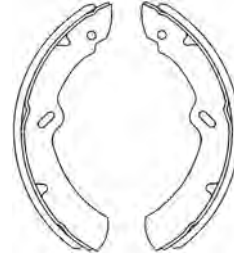

320.0 x 75.0

**N1583**

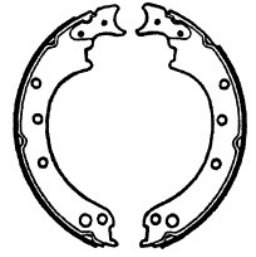

309.9 x 75.0

**N1606**

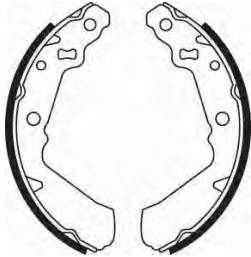

180.0 x 30.0

**N1607**

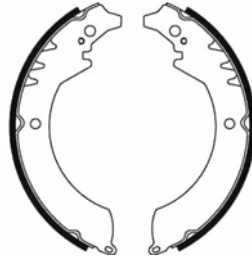

254.0 x 44.0

**N1608**

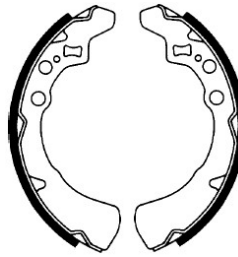

180.0 x 35.0

**N1609**

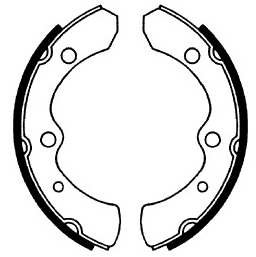

180.0 x 35.0

**N1632**

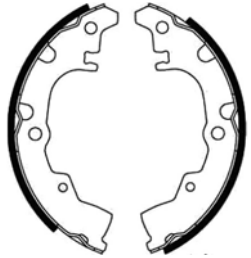

180.0 x 30.0

**N1638**

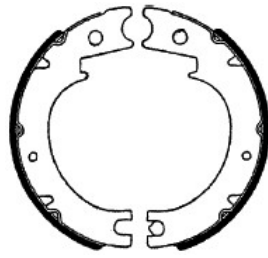

178.0 x 34.0

**N1658**

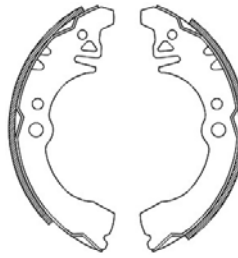

180.0 x 25.0

**N1670**

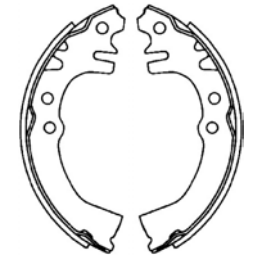

165.0 x 25.0

**N1673**

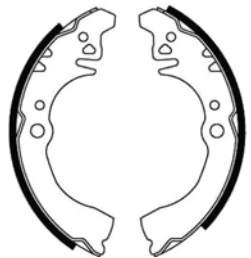

180.0 x 35.0

**N3101**

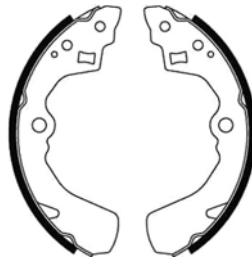

**N1682**  
200.0 x 30.0

**N3107**

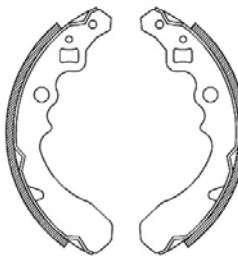

**N1688**  
165.0 x 25.0

**N3160**

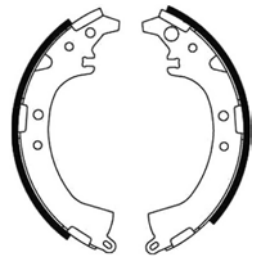

**N1747**  
228.6 x 40.0

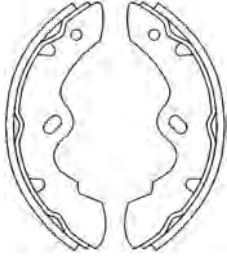
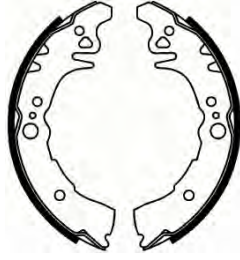
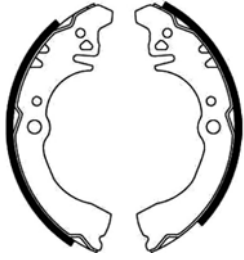

## DAIHATSU

<p><b>N3165</b></p>  <p><b>N1755</b></p> <p>200.0 x 35.0</p>	<p><b>N3175</b></p>  <p><b>N1765</b></p> <p>228.6 x 75.0</p>	<p><b>N3200</b></p>  <p><b>N1795</b></p> <p>180.0 x 25.0</p>	<p><b>N3203</b></p>  <p><b>N1799</b></p> <p>180.0 x 25.0</p>
--	---	--	---

## DODGE

### AT4 Series

114	1963 - 64	<b>N1081</b>	307.9 x 50.8	<b>N1081</b>	307.9 x 50.8
-----	-----------	--------------	--------------	--------------	--------------

### D50

1 Ton Pickup	1979 - 80			<b>N1403</b>	241.3 x 50.0
--------------	-----------	--	--	--------------	--------------

### Dart

SEDAN	1963 - 64	<b>N1286</b>	254.0 x 63.5	<b>N1286</b>	254.0 x 63.5
-------	-----------	--------------	--------------	--------------	--------------

### Phoenix

P & R SERIES	1960 - 61	<b>N1109</b>	279.4 x 50.8	<b>N1109</b>	279.4 x 50.8
SD2, TD, VD-2	1962 - 64	<b>N1286</b>	254.0 x 63.5	<b>N1286</b>	254.0 x 63.5
AP2-L2, DC6, DE6	1965 - 70	<b>N1050</b>	279.4 x 69.8	<b>N1051</b>	279.4 x 50.8
400DF6, DG6	1970 - 72			<b>N1051</b>	279.4 x 50.8

### Ram

3500	94 - 99			<b>N3173</b>	330.2 x 89.0
------	---------	--	--	--------------	--------------

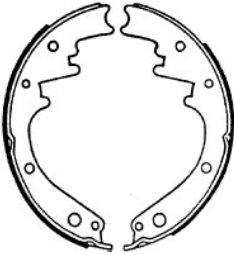
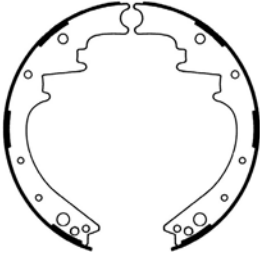
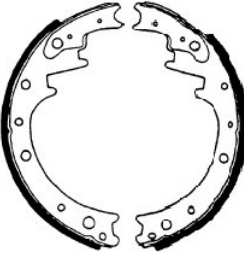
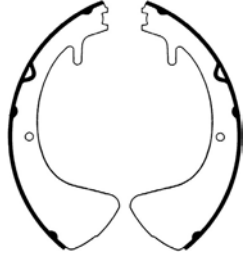
<p><b>N1050</b></p>  <p>279.4 x 69.8</p>	<p><b>N1051</b></p>  <p>279.4 x 50.8</p>	<p><b>N1081</b></p>  <p>307.9 x 50.8</p>	<p><b>N1109</b></p>  <p>279.4 x 50.8</p>
---	---	--	---





## DODGE

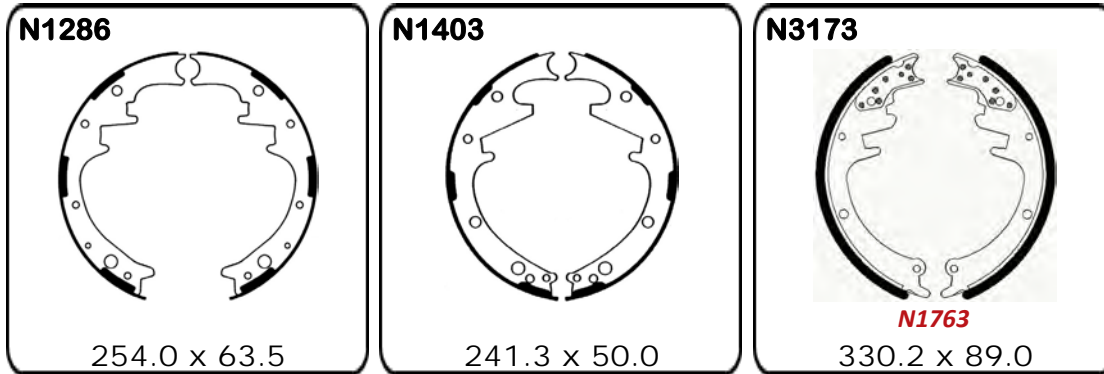

## FIAT

### 127/128 Series

All models	1975 - 78			<b>N1353</b>	185.0 x 30.0
------------	-----------	--	--	--------------	--------------

### 131 Series

All Models	1977 - 81			<b>N1416</b>	228.6 x 40.0
------------	-----------	--	--	--------------	--------------

### 850 Series

Fast Back Sedan	1965 - 68	<b>N1118</b>	185.0 x 30.0	<b>N1118</b>	185.0 x 30.0
S Sedan With Front Drums	1965 - 71	<b>N1126</b>	186.0 x 30.0	<b>N1126</b>	186.0 x 30.0
S Sedan With Front Disc	1965 - 71			<b>N1126</b>	186.0 x 30.0

### 1100 Series

103D, 103H Sedan Deluxe	1958 - 60	<b>N1113</b>	250.0 x 55.0	<b>N1156</b>	250.0 x 50.0
103G, 103H Sedan & Wagon	1960 - 62	<b>N1156</b>	250.0 x 50.0	<b>N1156</b>	250.0 x 50.0

### 1500 Series

All Models	1961 - 68			<b>N1134</b>	250.0 x 55.0
------------	-----------	--	--	--------------	--------------

### 1800 Series

Sedan T0 Chassis 028031	1961 - 62	<b>N1150</b>	280.0 x 65.0	<b>N1158</b>	280.0 x 50.0
Sedan From Chassis 028032	1962 - 64	<b>N1157</b>	280.0 x 65.0	<b>N1154</b>	280.0 x 50.0

### Argenta

All Models	1983 - 84			<b>N1370</b>	228.6 x 40.0
------------	-----------	--	--	--------------	--------------

### Regata Series



With Girling Brakes	1984 on			<b>N1353</b>	185.0 x 30.0
With Bendix Brakes	1985 - 90			<b>N1353</b>	185.0 x 30.0



## FIAT

### Superbrava

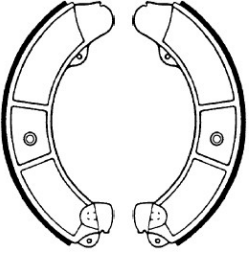
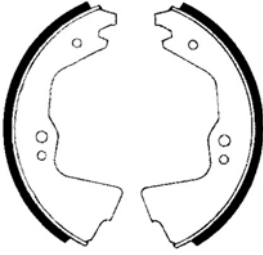
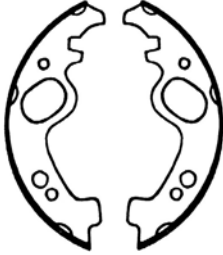
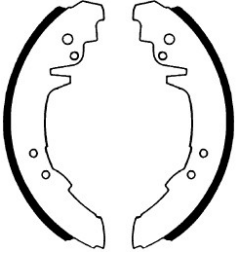
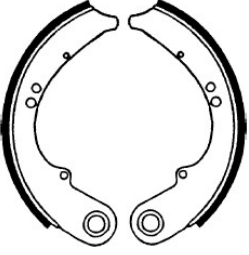
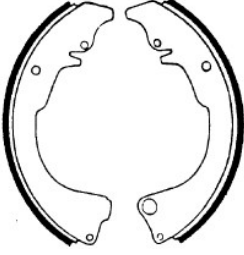
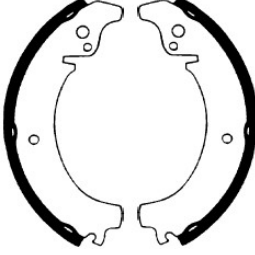
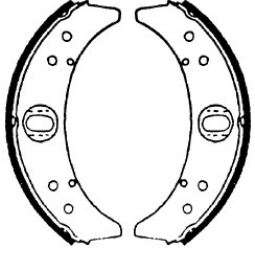
All Models	1981 - 84		<b>N1416</b>	228.6 x 40.0
------------	-----------	--	--------------	--------------

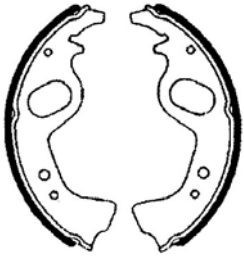
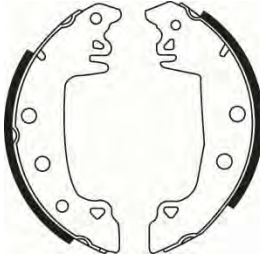
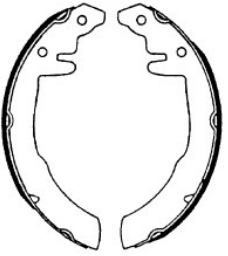
<p><b>N1113</b></p>  <p>250.0 x 55.0</p>	<p><b>N1118</b></p>  <p>185.0 x 30.0</p>	<p><b>N1126</b></p>  <p>186.0 x 30.0</p>	<p><b>N1134</b></p>  <p>250.0 x 55.0</p>
<p><b>N1150</b></p>  <p>280.0 x 65.0</p>	<p><b>N1154</b></p>  <p>280.0 x 50.0</p>	<p><b>N1156</b></p>  <p>250.0 x 50.0</p>	<p><b>N1157</b></p>  <p>280.0 x 65.0</p>
<p><b>N1158</b></p>  <p><b>No Profile Available</b></p> <p>280.0 x 50.0</p>	<p><b>N1353</b></p>  <p>185.0 x 30.0</p>	<p><b>N1370</b></p>  <p>228.6 x 40.0</p>	<p><b>N1416</b></p>  <p>228.6 x 40.0</p>



## FORD

### Anglia/Prefect

100E, 105E, 107E	1958 - 65	<b>N1086</b>	203.2 x 31.7	<b>N1087</b>	203.2 x 31.7
------------------	-----------	--------------	--------------	--------------	--------------

### Bronco

4WD Wagon	1980 - 92			<b>N1323</b>	280.1 x 57.1
-----------	-----------	--	--	--------------	--------------

### Capri

Sedan & GT 1600	To 9/1970			<b>N1169</b>	228.6 x 44.4
Sedan & GT 3000	To 9/70			<b>N1360</b>	228.6 x 57.1
Sedan & GT 1600	10/1970 on			<b>N1344</b>	228.6 x 44.4
Sedan & GT 3000	10/1970 on			<b>N1360</b>	228.6 x 57.1

### Consul

T0 Chassis 238911	1958 - 61	<b>N1145</b>	228.6 x 63.5	<b>N1142</b>	228.6 x 44.4
From Chassis 238912	1961	<b>N1145</b>	228.6 x 63.5	<b>N1144</b>	228.6 x 44.4

### Cortina

118E With Front Disc	1963 - 67			<b>N1089</b>	203.2 x 38.1
118E With Front Drum	1963 - 65	<b>N1090</b>	203.2 x 44.4	<b>N1089</b>	203.2 x 38.1
113E With Front Disc	1963 - 63			<b>N1089</b>	203.2 x 38.1
113E With Front Drum	1963 - 63	<b>N1088</b>	203.2 x 44.4	<b>N1089</b>	203.2 x 38.1
GT Sedan MK I	1963 - 65			<b>N1166</b>	228.6 x 44.4
GT Sedan MK I & MK II	1965 - 5/68			<b>N1169</b>	228.6 x 44.4
CD Series MK II	1967 - 71			<b>N1022</b>	203.2 x 38.1
GT Sedan MK II	6/68 - 1971			<b>N1169</b>	228.6 x 44.4
TC, TD Sedan & TC 4 Cyl Wagon	1971 - 77			<b>N1344</b>	228.6 x 44.4
TC 6 Cyl Wagon & TD All Wagons	1972 - 77			<b>N1364</b>	228.6 x 57.1
TE, TF All Models	1977 - 81			<b>N1364</b>	228.6 x 57.1

### Courier

Drum/Drum Models	1978 - 80	<b>N1389</b>	260.0 x 45.0	<b>N1389</b>	260.0 x 45.0
Ute Disc/Drum to Chassis 230828	8/1980 - 82			<b>N1389</b>	260.0 x 45.0
Ute Disc/Drum to Chassis 230829	1982 - 84			<b>N1411</b>	260.0 x 45.0
Ute XLT, Supercab	1985			<b>N1587</b>	260.0 x 50.0
UF 2WD & 4WD	1985 on			<b>N1665</b>	260.0 x 50.0
2WD	3/1996 on			<b>N1665</b>	260.0 x 50.0
4WD	3/1996 on			<b>N1665</b>	260.0 x 50.0
PE 4WD	1998 on			<b>N3179</b>	295.0 x 55.0
PE 2WD	1998 on			<b>N3053</b>	270.0 x 57.0
PH 4.0L	2005 - 06			<b>N3222</b>	295.0 x 55.0

### Custom

Custom Line	1951 - 59	<b>N1160</b>	279.4 x 57.1	<b>N1161</b>	279.4 x 44.4
Ranchwagon	1959 - 62	<b>N1160</b>	279.4 x 57.1	<b>N1167</b>	279.4 x 50.8



## FORD

### Econovan

Drum/Drum Models	1979 - 84	<b>N1391</b>	228.6 x 55.0	<b>N1392</b>	180.0 x 45.0
SB32 Van	1981 - 84			<b>N1389</b>	260.0 x 45.0
All Models With Dual Rear Wheels	1984 on			<b>N1588</b>	220.0 x 55.0
SB43 1.4L Van With Single Rear Wheels	1984 - 85			<b>N1585</b>	228.6 x 42.0
SB39 1.4L Van With Single Rear Wheels	1984 - 85			<b>N1586</b>	180.0 x 45.0
Maxi-Van SB72 With Single Rear Wheels	1984 on			<b>N1587</b>	260.0 x 50.0
JH Series	1999 - 3/01			<b>N3192</b>	270.0 x 50.0
Van	3/2001 - 07			<b>N3061</b>	270.0 x 50.0

### Escape

4D Wagon 3.0	1/2001 on			<b>N3000</b>	228.6 x 41.5
3.0L	05 on		<b>Handbrake</b>	<b>N3076</b>	186.0 x 30.0

### Escort

1100	1970 - 1/72	<b>N1235</b>	203.2 x 38.1	<b>N1187</b>	203.2 x 38.1
1300	1970 - 1/72			<b>N1087</b>	203.2 x 31.7
1300	2/72 - 9/75			<b>N1022</b>	203.2 x 38.1
1600 Twin Cam, GT	1970 - 72			<b>N1169</b>	228.6 x 44.4
1100	2/72 - 1973	<b>N1235</b>	203.2 x 38.1	<b>N1022</b>	203.2 x 38.1
1300 MKII	10/75 on			<b>N1381</b>	203.2 x 38.1
1600, 2000, RS2000	1976 - 80			<b>N1383</b>	228.6 x 44.4

### Explorer

Handbrake	1996 - 01		<b>Handbrake</b>	<b>N3184</b>	184.0 x 30.0
Wagon	2002 on		<b>Handbrake</b>	<b>N3057</b>	184.0 x 32.0

### F100

All models Drum/Drum	1968 - 72	<b>N1349</b>	280.1 x 76.2	<b>N1323</b>	280.1 x 57.1
All models Disc/Drum	1973 on			<b>N1323</b>	280.1 x 57.1
2WD & 4WD	1997 - 04		<b>Handbrake</b>	<b>N3208</b>	229.0 x 30.0
2WD & 4WD	1997 - 04			<b>N3207</b>	280.0 x 57.0
2WD & 4WD	2009 on		<b>Handbrake</b>	<b>N3210</b>	228.0 x 30.7

### F150

Disc/Drum	1979 on			<b>N1323</b>	280.1 x 57.1
2WD & 4WD	1997 - 04		<b>Handbrake</b>	<b>N3208</b>	229.0 x 30.0
2WD & 4WD	1997 - 04			<b>N3207</b>	280.0 x 57.0
2WD & 4WD	2009 on			<b>N3210</b>	228.0 x 30.7

### F250

2WD	1957 - 64	<b>N1012</b>	307.0 x 50.8	<b>N1012</b>	307.0 x 50.8
2WD	1965 - 66	<b>N1012</b>	307.0 x 50.8		
2WD	1967 - 73	<b>N1018</b>	304.8 x 76.2	<b>N1018</b>	304.8 x 76.2
4WD & 4WD Optional	1967 - 73			<b>N1014</b>	304.8 x 63.5
F250A 4WD	1974 - 75	<b>N1012</b>	307.0 x 50.8	<b>N1014</b>	304.8 x 63.5



## FORD

### F250

Up To 6990 GVW	1979 - 88			<b>N1014</b>	304.8 x 63.5
6900 GVW And Above	1979 - 80			<b>N1014</b>	304.8 x 63.5
6900 GVW And Above	1981 - 85			<b>N1018</b>	304.8 x 76.2
F250	1989 - 93			<b>N1014</b>	304.8 x 63.5
Alternate	1989 - 93			<b>N1018</b>	304.8 x 76.2
2WD & 4WD	1997 - 04		<b>Handbrake</b>	<b>N3208</b>	229.0 x 30.0
F250 With Rear ABS	1999 - 04		<b>Handbrake</b>	<b>N3046</b>	205.0 x 42.0

### F350

2WD	1967 - 73	<b>N1018</b>	304.8 x 76.2	<b>N1018</b>	304.8 x 76.2
F350A 2WD	1974 - 75			<b>N1018</b>	304.8 x 76.2
F350S 2WD	1975 - 77			<b>N1018</b>	304.8 x 76.2
F350A All Models	1977 - 88			<b>N1018</b>	304.8 x 76.2
2WD & 4WD	1987 - 98			<b>N3206</b>	308.0 x 88.9
2WD & 4WD	1999 - 04		<b>Handbrake</b>	<b>N3046</b>	205.0 x 42.0

### Fairlane

500 Sedan (58E)	1959 - 62	<b>N1160</b>	279.4 x 57.1	<b>N1161</b>	279.4 x 44.4
500 Sedan FB, FC, FD	1962 - 64	<b>N1270</b>	254.0 x 57.1	<b>N1271</b>	254.0 x 44.4
ZA - ZF Drum/Drum	1967 - 73	<b>N1270</b>	254.0 x 57.1	<b>N1271</b>	254.0 x 44.4
ZA - ZB	1967 - 69			<b>N1271</b>	254.0 x 44.4
ZC - ZG	1969 - 76			<b>N1271</b>	254.0 x 44.4
DF - DL Banksia Park Brake	3/1995 - 6/99	<b>Major</b>	PBK113	<b>Minor</b>	PBK112
NF - NL Banksia Park Brake	3/1995 - 6/99	<b>Major</b>	PBK113	<b>Minor</b>	PBK112
DU - NU Banksia Park Brake	9/1998 - 6/01	<b>Major</b>	PBK132	<b>Minor</b>	PBK141

### Fairmont/Falcon

XK, XL, XM, XP Wagon Drum/Drum	1960 - 66	<b>N1163</b>	228.6 x 57.1	<b>N1163</b>	228.6 x 57.1
XK, XL, XM, XP Sedan Drum/Drum	1960 - 66	<b>N1163</b>	228.6 x 57.1	<b>N1164</b>	228.6 x 38.1
XM, XP Van & Utes Drum/Drum	1964 - 66	<b>N1270</b>	254.0 x 57.1	<b>N1271</b>	254.0 x 44.4
XP - Sedan Disc/Drum	1965 - 66			<b>N1164</b>	228.6 x 38.1
XP - Wagon Disc/Drum	1965 - 66			<b>N1163</b>	228.6 x 57.1
XP - Van & Utes Disc/Drum	1965 - 66			<b>N1271</b>	254.0 x 44.4
XR - XA Sedan/Wagons, Most Vans & Utes	1966 - 73	<b>N1270</b>	254.0 x 57.1	<b>N1271</b>	254.0 x 44.4
XR - XT All Models Disc/Drum	1966 - 69			<b>N1271</b>	254.0 x 44.4
XW Disc/Drum Except PHII	1969 - 70			<b>N1271</b>	254.0 x 44.4
XW GTHO PHII	1969 - 70			<b>N1265</b>	254.0 x 63.5
XY - XF Disc/Drum, XF Ute & Van	1971 - 3/93			<b>N1271</b>	254.0 x 44.4
XA, Some Vans & Utes Drum/Drum	1972 - 73	<b>N1270</b>	254.0 x 57.1	<b>N1270</b>	254.0 x 57.1
EF - EL Banksia Park Brake	9/1994 - 8/98	<b>Major</b>	PBK113	<b>Minor</b>	PBK112
AU, AUII, AUIII All Models Banksia Park Brake	9/1998 - 4/00	<b>Major</b>	PBK132	<b>Minor</b>	PBK141
BA Sedan Banksia Park Brake	9/2002 on	<b>Major</b>	PBK170	<b>Minor</b>	PBK169



## FORD

### *Fairmont/Falcon*

BA Wagon Banksia Park Brake	9/2002 on	<b>Major</b>	PBK193	<b>Minor</b>	PBK192
-----------------------------	-----------	--------------	--------	--------------	--------

### *Festiva*

WA	6/91 - 1993			<b>N1664</b>	170.0 x 25.0
WB	1994 on			<b>N3113</b>	200.0 x 30.0
WD, WF	12/96 on			<b>N3113</b>	200.0 x 30.0

### *Fiesta*

1.6L Non-ABS	04 on			<b>N3074</b>	203.2 x 38.0
--------------	-------	--	--	--------------	--------------

### *Focus*

1.8 & 2.0L	1999 - 04			<b>N3204</b>	203.2 x 38.0
------------	-----------	--	--	--------------	--------------

### *KA*

1.3L Hatch With Lucas Brakes	1999 - 01			<b>N3186</b>	180.0 x 32.0
1.3L Hatch with Lockheed Brakes	1999 - 01			<b>N3201</b>	180.0 x 32.0

### *Laser*

KA, KB 1.3 & 1.5L	1981 - 85			<b>N1394</b>	180.0 x 30.0
KC, KE 1.6 L	1985 - 90			<b>N1604</b>	200.0 x 25.0
KE Wagon	1987 - 90			<b>N1637</b>	228.6 x 25.0
KF, KH Sedan SOHC	4/1990 - 8/91			<b>N1671</b>	200.0 x 25.0
KH	9/1991 on			<b>N3104</b>	200.0 x 35.0
KJ	1994 - 98			<b>N3104</b>	200.0 x 35.0
KN, KQ 1.6L	11/1998 on			<b>N3181</b>	200.0 x 35.0
KN 1.6L	3/1999 on			<b>N3104</b>	200.0 x 35.0

### *Maverick*

DA	1990 on			<b>N1668</b>	295.0 x 60.0
----	---------	--	--	--------------	--------------

### *Meteor*

GA, GB 1.5L	1982 - 85			<b>N1394</b>	180.0 x 30.0
GC Sedan	1985 on			<b>N1604</b>	200.0 x 25.0
GC Wagon	1985 - 86			<b>N1637</b>	228.6 x 25.0

### *Mustang*

6 Cyl Hardtop	1960 - 66	<b>N3095</b>	241.0 x 57.0	<b>N3097</b>	229.0 x 38.0
6 Cyl Convertible	1960 - 66	<b>N3095</b>	241.0 x 57.0	<b>N3095</b>	241.0 x 57.0
V8	1964 - 66	<b>N3096</b>	254.0 x 57.0	<b>N1518</b>	254.0 x 44.4
V8 390	1967	<b>N1265</b>	254.0 x 63.5	<b>N1518</b>	254.0 x 44.4
427, 428 V8	1967 - 73	<b>N1265</b>	254.0 x 63.5	<b>N1519</b>	254.0 x 50.8
V8 Except 390	1967 - 72	<b>N3096</b>	254.0 x 57.0	<b>N1518</b>	254.0 x 44.4
All Models	1974			<b>N3098</b>	229.0 x 44.5
All Models	1975 - 93			<b>N3099</b>	229.0 x 44.5

### *Raider*

2.6L 4WD	7/1991 on			<b>N1665</b>	260.0 x 50.0
----------	-----------	--	--	--------------	--------------





## FORD

### Ranger

Excl: High Rider	2006 on			<b>N3179</b>	295.0 x 55.0
------------------	---------	--	--	--------------	--------------

### Spectron

SB55,SB56 Van 1.6L	1983 - 84			<b>N1392</b>	180.0 x 45.0
Van, Bus, Spacer 1.8L	1984			<b>N1585</b>	228.6 x 42.0

### Telstar

AR, AS All Models 2.0L	1983 - 87			<b>N1409</b>	200.0 x 25.0
------------------------	-----------	--	--	--------------	--------------

### Territory

SX Handbrake	5/04 - 12/04	<b>Major</b>	PBK170	<b>Minor</b>	PBK169
--------------	--------------	--------------	--------	--------------	--------

### Thames

Van 250Kg, 350Kg	1957 - 64	<b>N1086</b>	203.2 x 31.7	<b>N1087</b>	203.2 x 31.7
Van Series 800, 750Kg	1958 - 60	<b>N1145</b>	228.6 x 63.5	<b>N1142</b>	228.6 x 44.4
Van Series 800, 750Kg	1962 - 66	<b>N1145</b>	228.6 x 63.5	<b>N1464</b>	228.6 x 44.4
Van 250Kg, 350Kg	1964 - 66	<b>N1086</b>	203.2 x 31.7	<b>N1148</b>	203.2 x 31.7

### Trader

0409 Petrol	1979 - 81	<b>N1520</b>	320.0 x 60.0	<b>N1520</b>	320.0 x 60.0
0409 Petrol	1979 - 81		<b>Handbrake</b>	<b>N1545</b>	170.0 x 30.0
0509 All Models	1979 - 81	<b>N1522</b>	320.0 x 75.0	<b>N1524</b>	320.0 x 75.0
0509 All Models	1979 - 81		<b>Handbrake</b>	<b>N1545</b>	170.0 x 30.0
0409 Petrol	1981 - 84		<b>Handbrake</b>	<b>N1546</b>	180.0 x 35.0
0711 3750 & 4000Kg Cab Chassis	1981 - 84	<b>N1590</b>	320.0 x 90.0	<b>N1589</b>	320.0 x 90.0
0509 All Models	1981 - 84	<b>N1521</b>	320.0 x 75.0	<b>N1523</b>	320.0 x 75.0
0409 Petrol	1981 - 84	<b>N1521</b>	320.0 x 75.0	<b>N1523</b>	320.0 x 75.0
0509 All Models	1981 - 84		<b>Handbrake</b>	<b>N1546</b>	180.0 x 35.0
0811 3750KG Cab Chassis WA82	1983 - 84	<b>N1590</b>	320.0 x 90.0	<b>N1589</b>	320.0 x 90.0
0509 2750 & 3000Kg WF78 Crew Cab, WB 15N Cab Chas	1984 - 88		<b>Handbrake</b>	<b>N1546</b>	180.0 x 35.0
0409 3500 Non-Turbo	3/1984 - 9/89	<b>N1521</b>	320.0 x 75.0	<b>N1523</b>	320.0 x 75.0
4000Kg Cab Chassis WC90, WA92	1984 - 3/87	<b>N3126</b>	320.0 x 110.0	<b>N3127</b>	320.0 x 110.0
4000Kg Cab Chassis WC90, WA92	1984 - 3/87	<b>N3126</b>	320.0 x 110.0	<b>N1547</b>	203.2 x 45.0
0509 3500 Turbo & 4100	3/1984 - 9/89	<b>N3126</b>	320.0 x 110.0	<b>N3127</b>	320.0 x 110.0
0509 3500 Non-Turbo	3/1984 - 9/89	<b>N1521</b>	320.0 x 75.0	<b>N1523</b>	320.0 x 75.0
0409 3500 Turbo & 4100	3/1984 - 9/89	<b>N3126</b>	320.0 x 110.0	<b>N3127</b>	320.0 x 110.0
0409 3500 Turbo & 4100	1984 - 88		<b>Handbrake</b>	<b>N1546</b>	180.0 x 35.0
Except WC90 WA92	T0 1988		<b>Handbrake</b>	<b>N1546</b>	180.0 x 35.0
Except WC90 WA92	1988 on		<b>Handbrake</b>	<b>N3138</b>	190.0 x 35.0
0409 3500 Turbo & 4100	1988 on		<b>Handbrake</b>	<b>N3138</b>	190.0 x 35.0
0509 2750 & 3000Kg WF78 Crew Cab, WB 15N Cab Chas	1988 on		<b>Handbrake</b>	<b>N3138</b>	190.0 x 35.0
0812 3.5D Turbo WT89, WT90	10/1989 - 4/92	<b>N3126</b>	320.0 x 110.0	<b>N3127</b>	320.0 x 110.0



## FORD

### Trader

WT87, WT88, WV09, WV10 Cab Chassis	1989 - 3/92	<b>N3126</b>	320.0 x 110.0	<b>N3127</b>	320.0 x 110.0
0409 2000Kg WT85, WV08 Cab/Chassis	9/1989 - 4/92	<b>N1521</b>	320.0 x 75.0	<b>N1523</b>	320.0 x 75.0
0509 WF13 Crew Cab, WT86, WV08 Cab Chas	6/1989 - 4/92	<b>N1521</b>	320.0 x 75.0	<b>N1523</b>	320.0 x 75.0
0811 3750 & 4000Kg WF28, WF55 Cew Cab	1989 - 3/92	<b>N3126</b>	320.0 x 110.0	<b>N3127</b>	320.0 x 110.0
0409 2000Kg WV14, WV15 Cab/Chassis	6/1992 on	<b>N3108</b>	320.0 x 90.0	<b>N3109</b>	320.0 x 90.0
0509 WF78 Crew Cab, WB 15N Cab Chassis	6/1992 on	<b>N3108</b>	320.0 x 90.0	<b>N3109</b>	320.0 x 90.0
0811 3750 & 4000Kg WF55, WF77 Crew Cab	4/1992 on	<b>N3126</b>	320.0 x 110.0	<b>N3127</b>	320.0 x 110.0
WV10, WV16, WV17 Cab Chassis	4/1992 on	<b>N3126</b>	320.0 x 110.0	<b>N3127</b>	320.0 x 110.0
0811 WT85, WV08, WV09 Cab Chassis	4/92 on	<b>N3108</b>	320.0 x 90.0	<b>N3109</b>	320.0 x 90.0

### Transit

100 Van 4 Cyl	1965 - 70	<b>N1037</b>	228.6 x 69.8	<b>N1036</b>	228.6 x 44.4
115 Bus 4 Cyl	1965 - 68	<b>N1037</b>	228.6 x 69.8	<b>N1037</b>	228.6 x 69.8
150 Van Disc/Drum	1965 - 76			<b>N1031</b>	254.0 x 69.8
115 Bus 6 Cyl	1969 - 73	<b>N1035</b>	254.0 x 69.8	<b>N1036</b>	228.6 x 44.4
100 Van 4 Cyl	1971 - 72	<b>N1035</b>	254.0 x 69.8	<b>N1036</b>	228.6 x 44.4
115 Bus 6 Cyl	1973 - 76	<b>N1035</b>	254.0 x 69.8	<b>N1031</b>	254.0 x 69.8
100 Van 4 Cyl	1973 - 75	<b>N1035</b>	254.0 x 69.8	<b>N1031</b>	254.0 x 69.8
125 Van, Bus	1976 - 79			<b>N1465</b>	254.0 x 69.8
175 Van	1976 - 81			<b>N1466</b>	254.0 x 69.8
125 Van, Bus	7/1979 - 1981			<b>N1465</b>	254.0 x 69.8
120 Van 4 Cyl & PMG Vehicle	1984 - 85			<b>N1465</b>	254.0 x 69.8
80, 100 Van	1987 on			<b>N3105</b>	254.0 x 69.8
120 Van	1987 - 5/91			<b>N3106</b>	228.6 x 44.4
120 Van Short Wheel Base	6/91 on			<b>N3151</b>	254.0 x 52.0
130, 150, 190 Van Long Wheel Base	1992 on			<b>N3150</b>	280.0 x 65.0
130, 150, 190 Van Long Wheel Base	2000 on			<b>N3183</b>	280.0 x 65.0

**N1012**

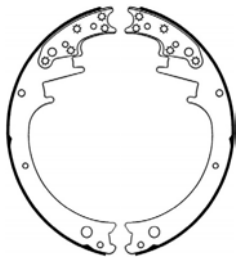

307.0 x 50.8

**N1014**

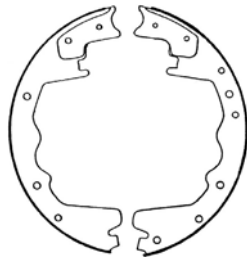

304.8 x 63.5

**N1018**

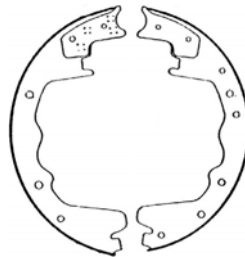

304.8 x 76.2

**N1022**



203.2 x 38.1



## FORD

**N1031**

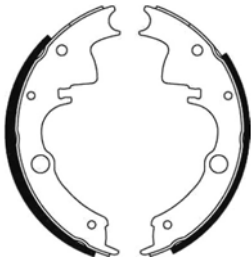

254.0 x 69.8

**N1035**

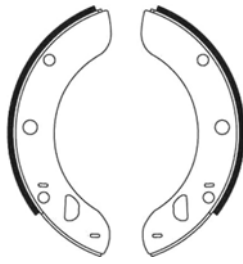

254.0 x 69.8

**N1036**

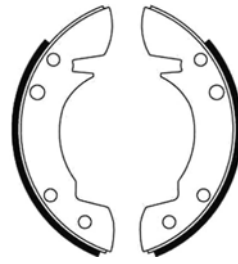

228.6 x 44.4

**N1037**

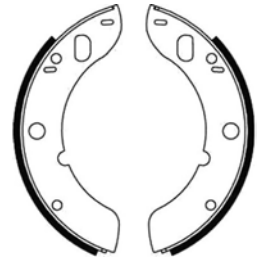

228.6 x 69.8

**N1086**

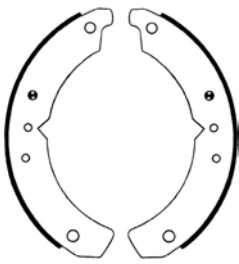

203.2 x 31.7

**N1087**

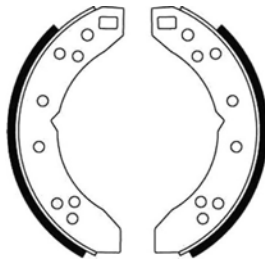

203.2 x 31.7

**N1088**

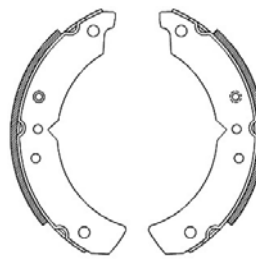

203.2 x 44.4

**N1089**

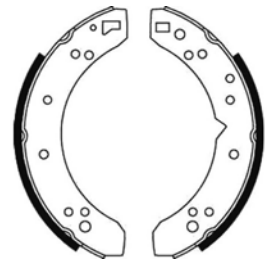

203.2 x 38.1

**N1090**

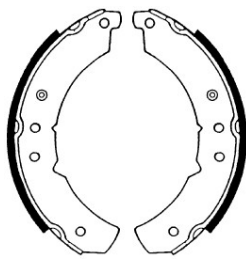

203.2 x 44.4

**N1142**

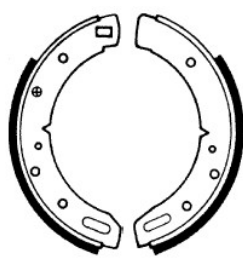

228.6 x 44.4

**N1144**

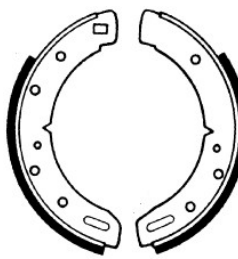

228.6 x 44.4

**N1145**

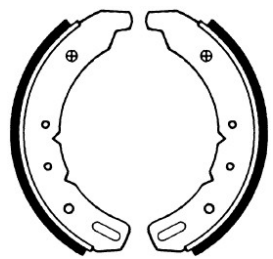

228.6 x 63.5

**N1148**

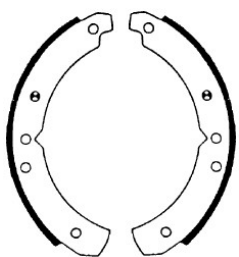

203.2 x 31.7

**N1160**

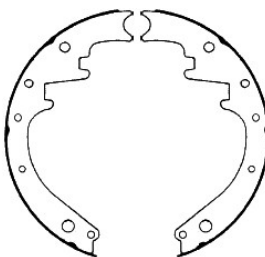

279.4 x 57.1

**N1161**

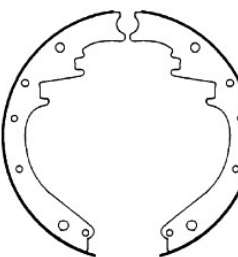

279.4 x 44.4

**N1163**

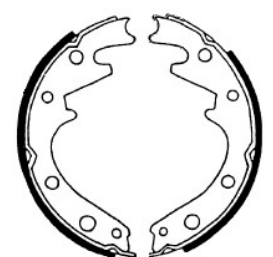

228.6 x 57.1



## FORD

**N1164**

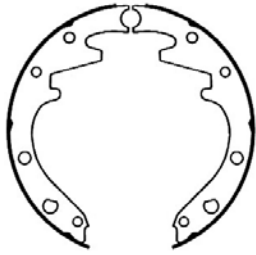

228.6 x 38.1

**N1166**

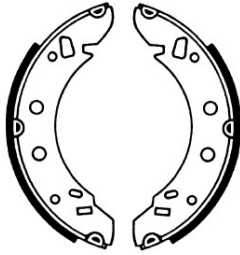

228.6 x 44.4

**N1167**

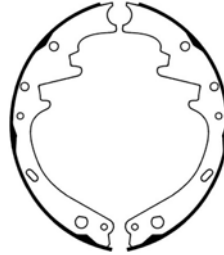

279.4 x 50.8

**N1169**

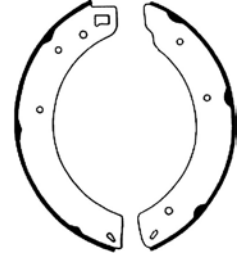

228.6 x 44.4

**N1187**

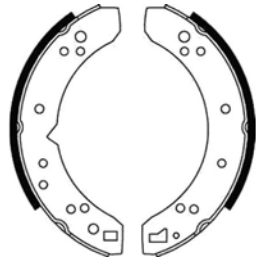

203.2 x 38.1

**N1235**

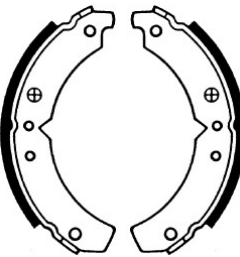

203.2 x 38.1

**N1265**

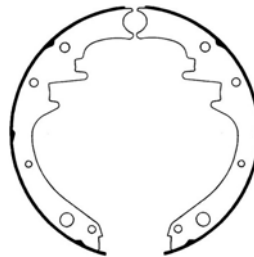

254.0 x 63.5

**N1270**

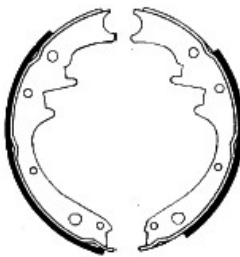

254.0 x 57.1

**N1271**

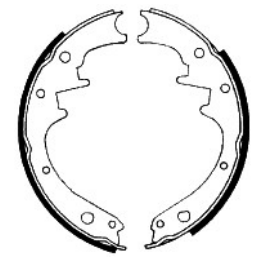

254.0 x 44.4

**N1323**

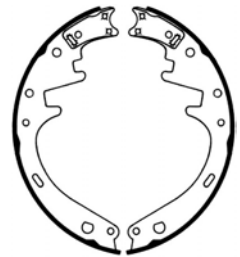

280.1 x 57.1

**N1344**

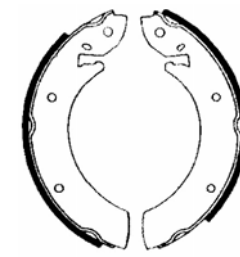

228.6 x 44.4

**N1349**

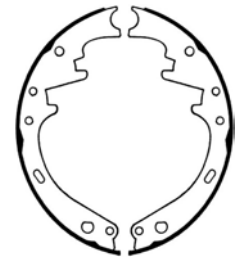

280.1 x 76.2

**N1360**

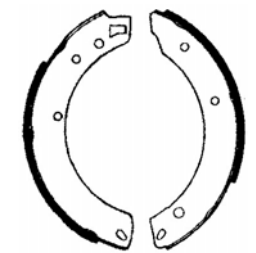

228.6 x 57.1

**N1364**

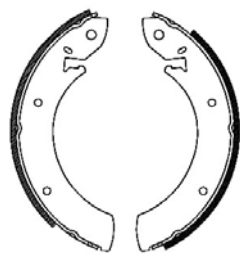

228.6 x 57.1

**N1381**

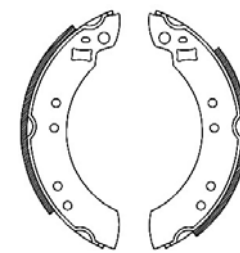

203.2 x 38.1

**N1383**

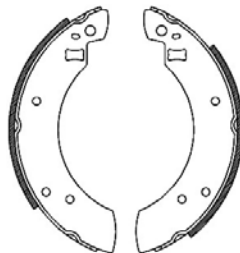

228.6 x 44.4





## FORD

**N1389**



260.0 x 45.0

**N1391**

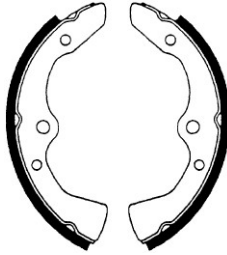

228.6 x 55.0

**N1392**

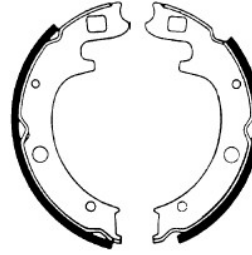

180.0 x 45.0

**N1394**

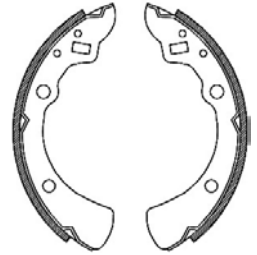

180.0 x 30.0

**N1409**

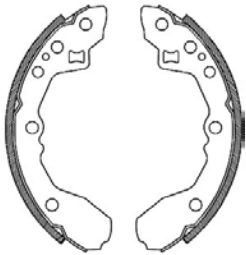

200.0 x 25.0

**N1411**

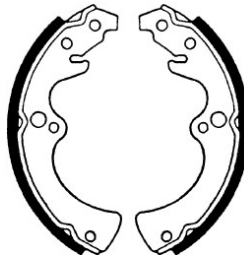

260.0 x 45.0

**N1464**

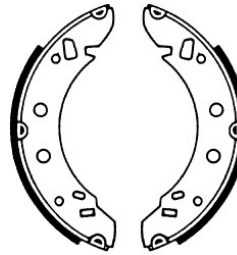

228.6 x 44.4

**N1465**

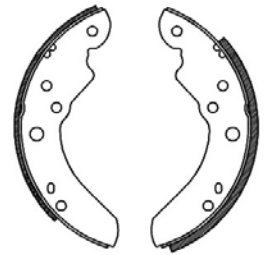

254.0 x 69.8

**N1466**

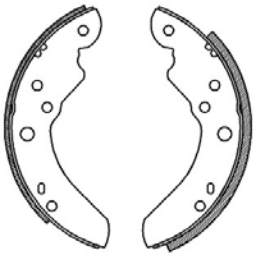

254.0 x 69.8

**N1518**

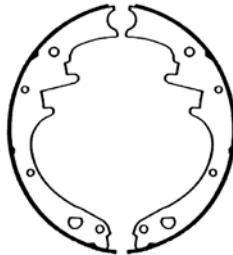

254.0 x 44.4

**N1519**

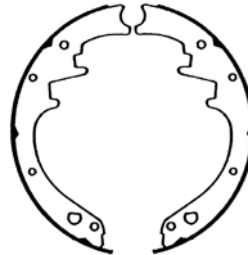

254.0 x 50.8

**N1520**

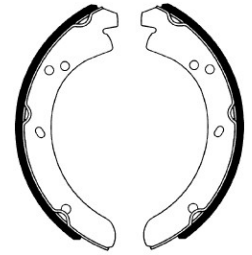

320.0 x 60.0

**N1521**

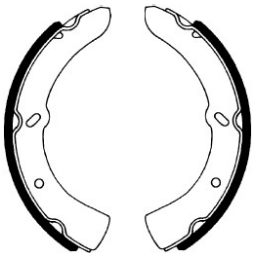

320.0 x 75.0

**N1522**

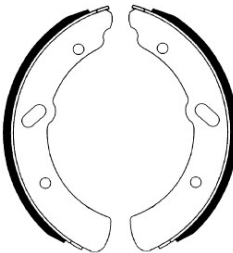

320.0 x 75.0

**N1523**

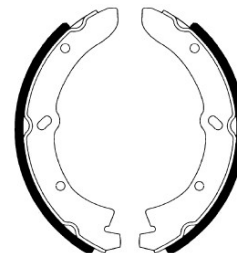

320.0 x 75.0

**N1524**

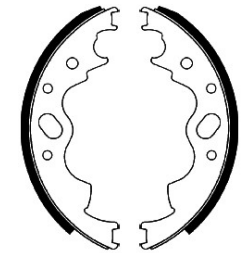

320.0 x 75.0



## FORD

**N1545**

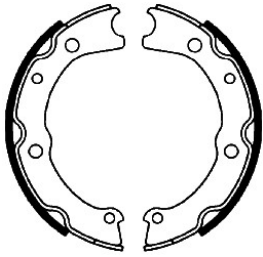

170.0 x 30.0

**N1546**

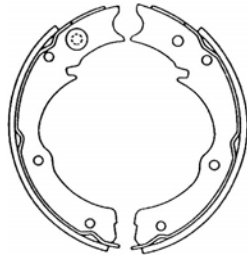

180.0 x 35.0

**N1547**

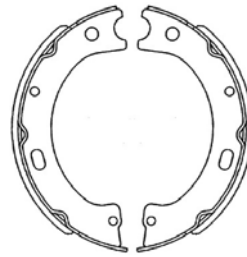

203.2 x 45.0

**N1585**

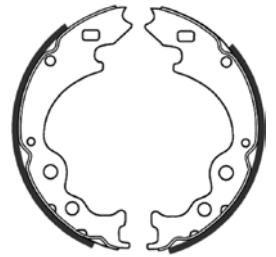

228.6 x 42.0

**N1586**

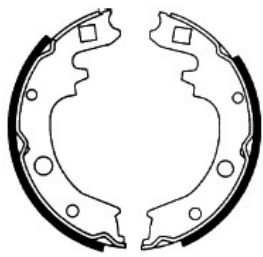

180.0 x 45.0

**N1587**

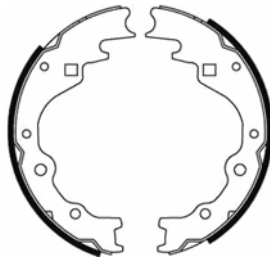

260.0 x 50.0

**N1588**

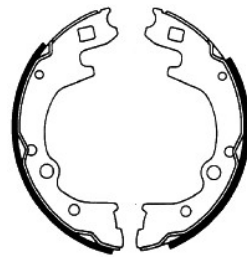

220.0 x 55.0

**N1589**

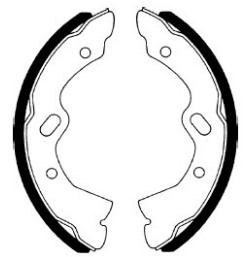

320.0 x 90.0

**N1590**

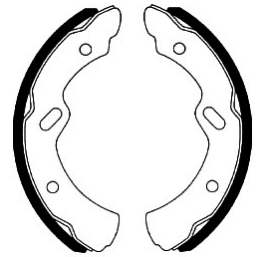

320.0 x 90.0

**N1604**

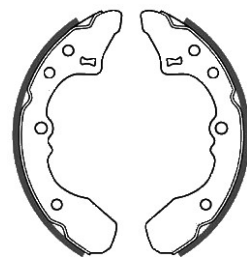

200.0 x 25.0

**N1637**

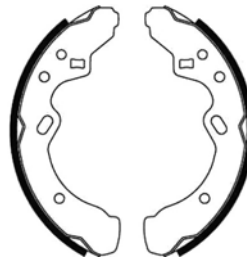

228.6 x 25.0

**N1664**



170.0 x 25.0

**N1665**

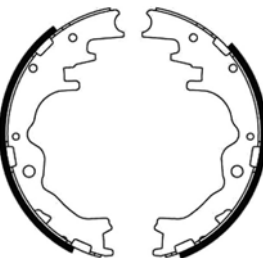

260.0 x 50.0

**N1668**

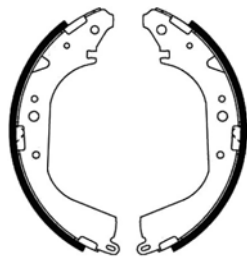

295.0 x 60.0

**N1671**

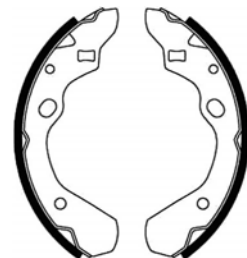

200.0 x 25.0

**N3000**

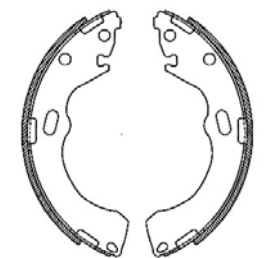

**N1791**  
228.6 x 41.5





## FORD

**N3046**

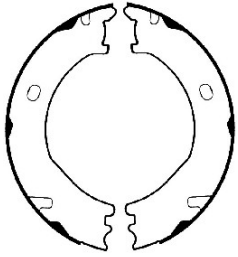

**N1837**

205.0 x 42.0

**N3053**

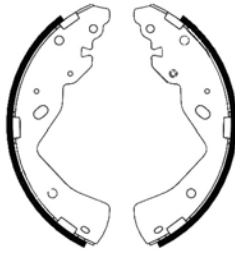

**N1822**

270.0 x 57.0

**N3057**

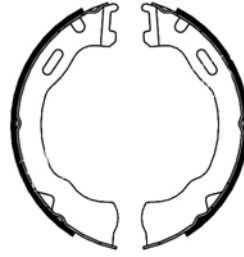

**N1868**

184.0 x 32.0

**N3061**

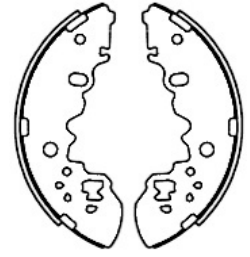

**N1863**

270.0 x 50.0

**N3074**

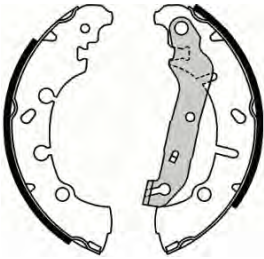

**N1830**

203.2 x 38.0

**N3076**



**N1883/BS5017**

186.0 x 30.0

**N3095**

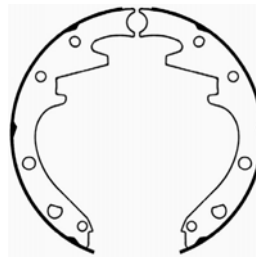

241.0 x 57.0

**N3096**

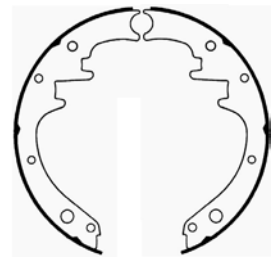

254.0 x 57.0

**N3097**

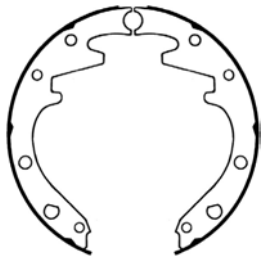

229.0 x 38.0

**N3098**

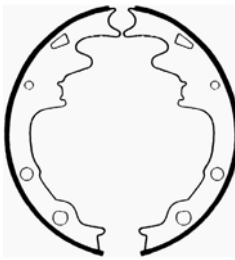

229.0 x 44.5

**N3099**

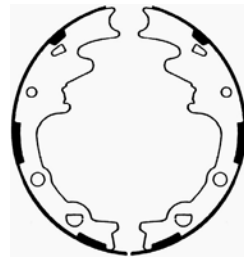

229.0 x 44.5

**N3104**

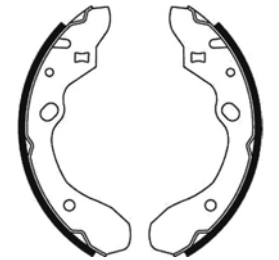

**N1685**

200.0 x 35.0

**N3105**

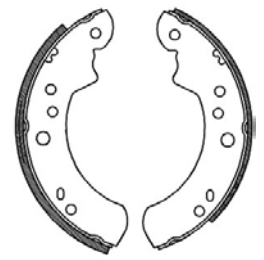

**N1686**

254.0 x 69.8

**N3106**

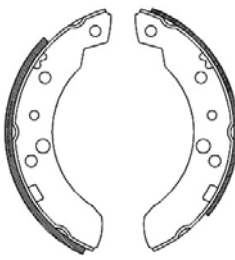

**N1687**

228.6 x 44.4

**N3108**

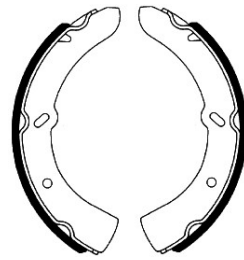

**N1689**

320.0 x 90.0

**N3109**

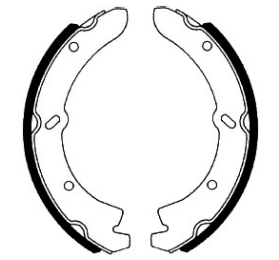

**N1690**

320.0 x 90.0



## FORD

**N3113**

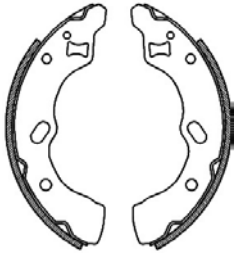

**N1694**

200.0 x 30.0

**N3126**

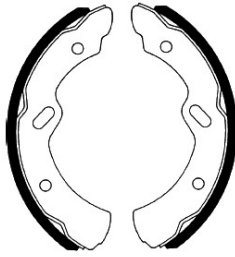

**N1708**

320.0 x 110.0

**N3127**

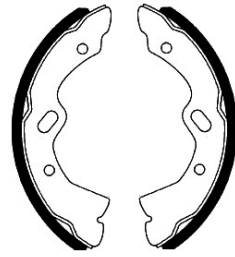

**N1709**

320.0 x 110.0

**N3138**

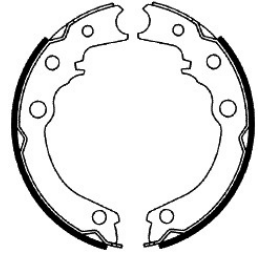

**N1720**

190.0 x 35.0

**N3150**

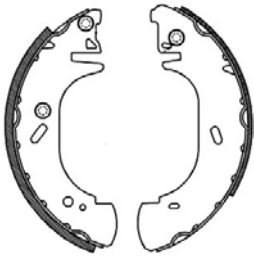

**N1737**

280.0 x 65.0

**N3151**

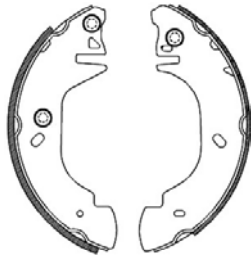

**N1738**

254.0 x 52.0

**N3179**

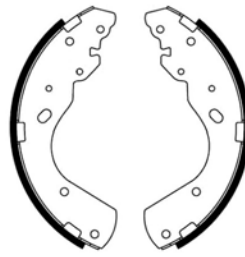

**N1769**

295.0 x 55.0

**N3181**

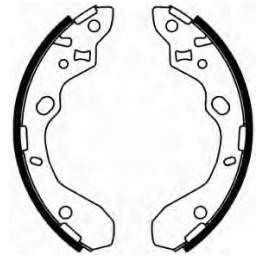

**N1771**

200.0 x 35.0

**N3183**

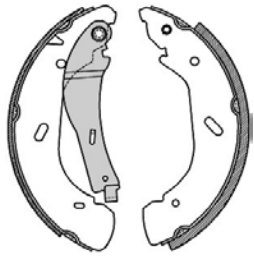

**N1773**

280.0 x 65.0

**N3184**

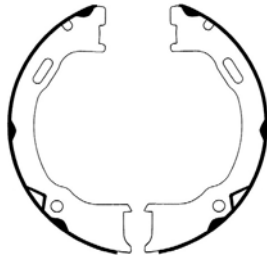

**N1774**

184.0 x 30.0

**N3186**

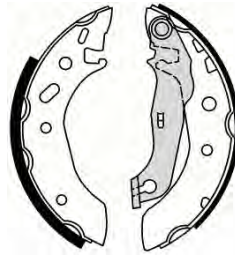

**N1776**

180.0 x 32.0

**N3192**

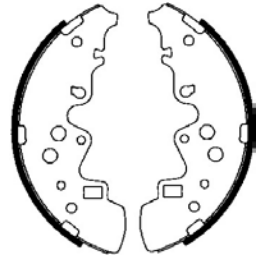

**N1784**

270.0 x 50.0

**N3201**

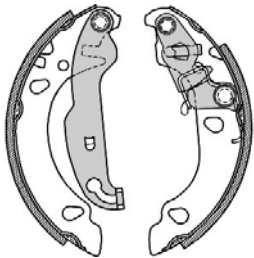

**N1798**

180.0 x 32.0

**N3204**



**N1826/BS5010**

203.2 x 38.0

**N3206**

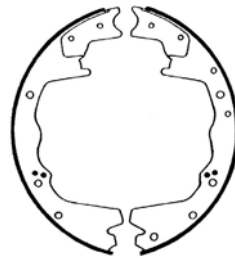

308.0 x 88.9

**N3207**

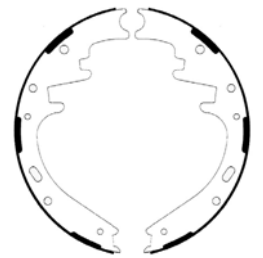

280.0 x 57.0



## FORD

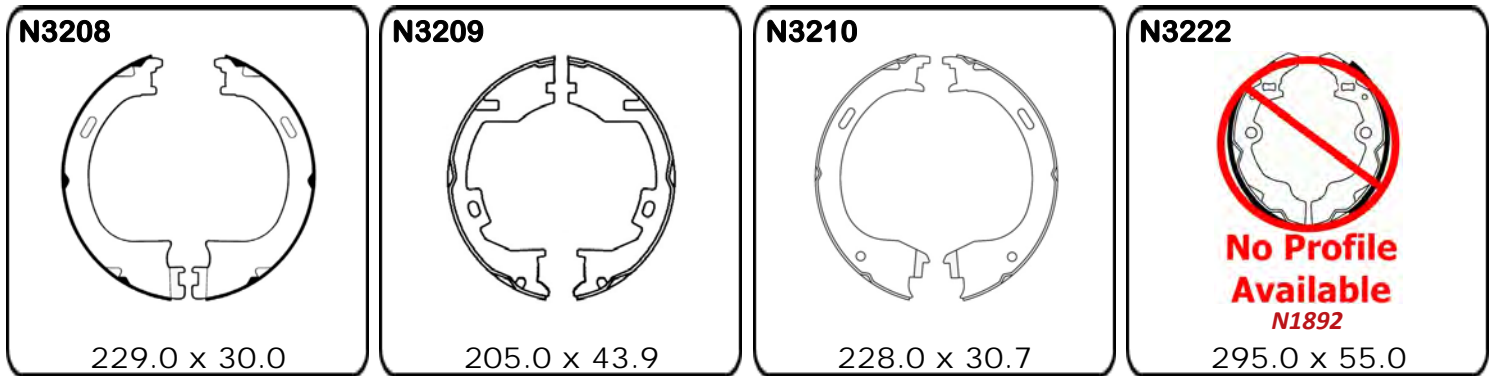

## HILLMAN

<b>Arrow</b>					
HB Without Power Brakes	1967 - 68			<b>N1296</b>	228.6 x 44.4
HB Without Power Brakes	1968 - 74			<b>N1008</b>	228.6 x 44.4
HC, HE	1968 - 74			<b>N1008</b>	228.6 x 44.4
<b>Gazelle</b>					
Gazelle	1966 - 67			<b>N1008</b>	228.6 x 44.4
<b>Hunter</b>					
HB Without Power Brakes	1967 - 68			<b>N1296</b>	228.6 x 44.4
HB Without Power Brakes	1968 - 74			<b>N1008</b>	228.6 x 44.4
HC, HE	1968 - 74			<b>N1008</b>	228.6 x 44.4
<b>Husky</b>					
Series I & II	1955 - 62	<b>N1230</b>	203.2 x 38.1	<b>N1230</b>	203.2 x 38.1
Series III 1592cc	1960 - 64	<b>N1230</b>	203.2 x 38.1	<b>N1298</b>	228.6 x 44.4
Series V Deluxe 1592cc	1964 - 65			<b>N1296</b>	228.6 x 44.4
Series VI Station Wagon 1725cc	1965 - 66			<b>N1296</b>	228.6 x 44.4
Series IV Deluxe 1592cc	1966 - 64			<b>N1298</b>	228.6 x 44.4
<b>Hustler</b>					
HB Without Power Brakes	1967 - 68			<b>N1296</b>	228.6 x 44.4
HC, HE	1968 - 74			<b>N1008</b>	228.6 x 44.4
HB Without Power Brakes	1968 - 74			<b>N1008</b>	228.6 x 44.4
<b>Imp</b>					
Imp	1963 - 68	<b>N1235</b>	203.2 x 38.1	<b>N1089</b>	203.2 x 38.1



## HILLMAN

### Minx

Series I & II	1955 - 62	<b>N1230</b>	203.2 x 38.1	<b>N1230</b>	203.2 x 38.1
Series III 1592cc	1960 - 64	<b>N1230</b>	203.2 x 38.1	<b>N1298</b>	228.6 x 44.4
Series V Deluxe 1592cc	1964 - 65			<b>N1296</b>	228.6 x 44.4
Series VI Station Wagon 1725cc	1965 - 66			<b>N1296</b>	228.6 x 44.4
Series IV Deluxe 1592cc	1966 - 64			<b>N1298</b>	228.6 x 44.4

### Super Minx

Series I	1963 - 63	<b>N1298</b>	228.6 x 44.4	<b>N1298</b>	228.6 x 44.4
Series III to Chasis No B14006288	1964 - 65			<b>N1298</b>	228.6 x 44.4
Series III from Chassis No. B14006289	1965 - 66			<b>N1296</b>	228.6 x 44.4
Series VI	1966 - 67			<b>N1296</b>	228.6 x 44.4

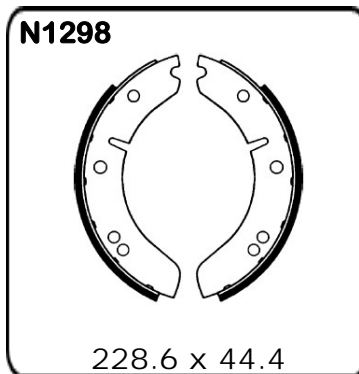
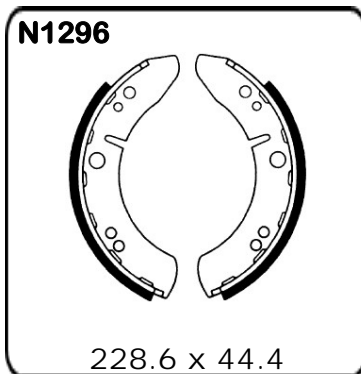
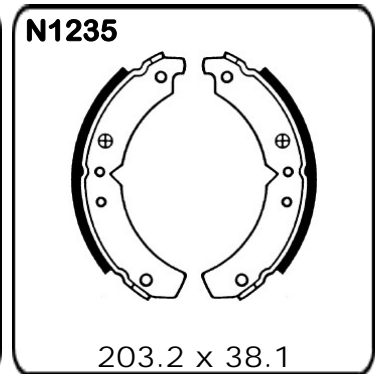
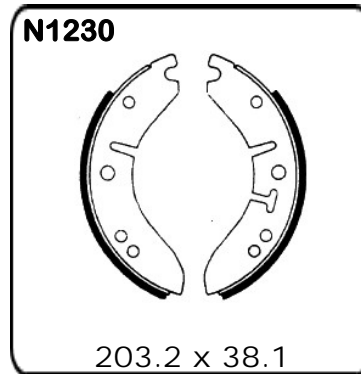
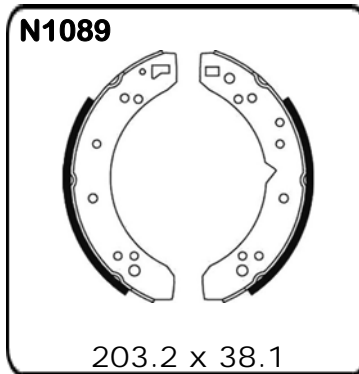
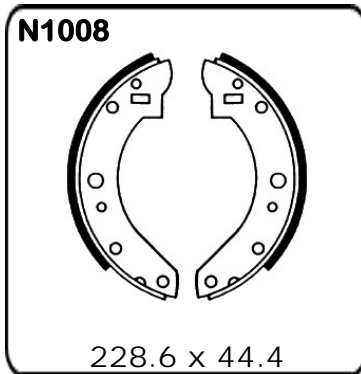

## HINO

### Dutro

XZU410, 411, 414, 424, 434, 420 ,430	1999 on			<b>N3159</b>	320.0 x 83.0
--------------------------------------	---------	--	--	--------------	--------------



## HINO

### Dutro

XZU410, 411M, 420, 430M - Handbrake	2000 - 03		Handbrake	N3156	200.0 x 45.0
XZU307	10/00 - 6/02			N1629	295.0 x 75.0
XZU302M Short & Mono - Handbrake	2000 - 03		Handbrake	N1542	160.0 x 35.0
XZU307 Flat Low - Handbrake	2000 - 03		Handbrake	N1542	160.0 x 35.0
XZU342 Medium - Handbrake	2000 - 03		Handbrake	N1542	160.0 x 35.0
XZU Series With 304mm Handbrake	2000 - 03		Handbrake	N3079	304.0 x 75.0
XZU402, 412 - Handbrake	10/2000 - 6/02		Handbrake	N1543	178.0 x 35.0
XZU305	12/02 - 10/06			N1629	295.0 x 75.0
XZU305, 404, 414 - Handbrake	2003 - 06		Handbrake	N1543	178.0 x 35.0
XZU414, 424, 434 - Handbrake	2003 - 07		Handbrake	N3156	200.0 x 45.0

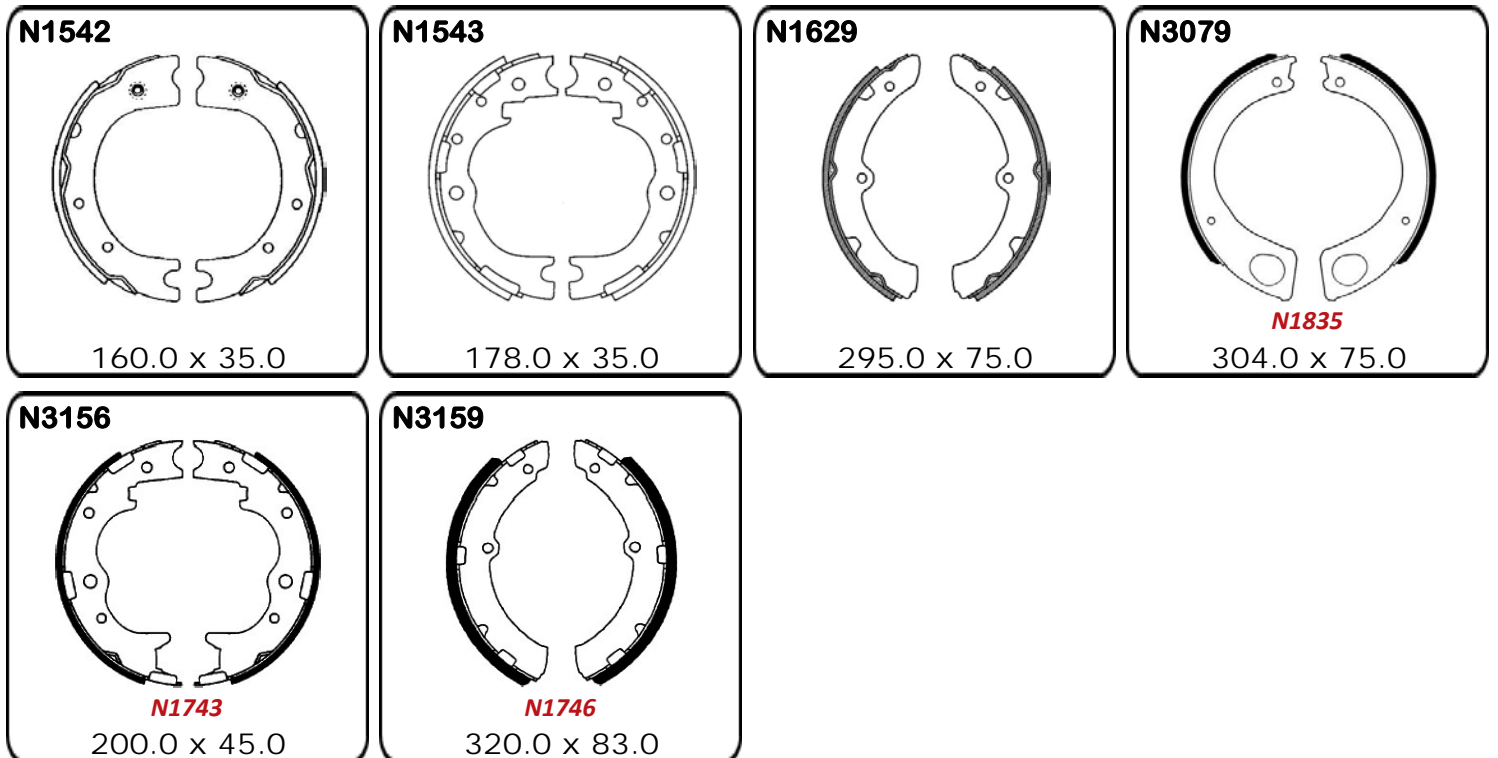

## HOLDEN

### Apollo

JK, JL 2.0L	1989 - 2/93			N1659	228.6 x 40.0
-------------	-------------	--	--	-------	--------------





## HOLDEN

### Apollo

JM 2.2L 4 Cyl	3/1993 - 6/95			<b>N1659</b>	228.6 x 40.0
Handbrake For Disc/Disc Models	8/1995 on		<b>Handbrake</b>	<b>N3162</b>	170.0 x 30.0

### Astra

LB, LC All Models	1984 - 87			<b>N1399</b>	180.0 x 35.0
LB, LC Some Models	1984 - 87			<b>N1672</b>	180.0 x 35.0
LD ALL MODELS	1987 - 89			<b>N1598</b>	203.2 x 35.0
TR ASTRA CITY 1.6L	9/1996 on			<b>N3128</b>	200.0 x 45.0

### Barina

MB, ML	1985 - 89			<b>N1616</b>	180.0 x 30.0
MF, MH	1989 - 8'91			<b>N1616</b>	180.0 x 30.0
MH	9/91 - 3/94			<b>N3103</b>	180.0 x 25.0
SB	4/1994 - 01			<b>N3124</b>	200.0 x 29.0
XC	01 - 05			<b>N3124</b>	200.0 x 29.0
TK 1.6L	2005 on			<b>N3058</b>	200.0 x 36.1

### Camira

JB, JD, JE	1982 - 89			<b>N1385</b>	230.0 x 50.0
------------	-----------	--	--	--------------	--------------

### Captiva

CG Handbrake Shoes	2007 on		<b>Handbrake</b>	<b>N3225</b>	190.0 x 26.2
--------------------	---------	--	------------------	--------------	--------------

### Combo

SB	2/1996 on			<b>N3145</b>	230.0 x 50.0
SC	8/2001 - 06			<b>N3196</b>	228.6 x 42.0
XC Non-ABS	06 on			<b>N3124</b>	200.0 x 29.0

### Commodore

VB - VL All Models	1978 - 87			<b>N1385</b>	230.0 x 50.0
Disc/Disc Models	1980 - 88		<b>Handbrake</b>	<b>N1412</b>	160.0 x 25.0
Disc/Disc Models	1988 on		<b>Handbrake</b>	<b>N1669</b>	160.0 x 25.0
VT, VX Handbrake	9/97 - 9/02	<b>Major</b>	PBK217	<b>Minor</b>	PBK216
VU Ute Banksia Park Brake	12/2000 - 6/01	<b>Major</b>	PBK217	<b>Minor</b>	PBK216
VX Banksia Park Brake	10/2000 - 6/01	<b>Major</b>	PBK217	<b>Minor</b>	PBK216
VY Handbrake	9/02 - 7/04	<b>Major</b>	PBK194	<b>Minor</b>	PBK176
VZ Handbrake	8/04 - 11/04	<b>Major</b>	PBK217	<b>Minor</b>	PBK216

### Crewman

VY, VZ Handbrake	12/03 - 3/05	<b>Major</b>	PBK194	<b>Minor</b>	PBK176
------------------	--------------	--------------	--------	--------------	--------

### Cruze

HR Series	2000 - 03			<b>N3021</b>	180.0 x 25.0
-----------	-----------	--	--	--------------	--------------

### Drover

4WD Drum/Drum	1985 on	<b>N1539</b>	220.0 x 39.0	<b>N1539</b>	220.0 x 39.0
4WD - Disc/Drum Some models	1985 on			<b>N1628</b>	220.0 x 39.0





## HOLDEN

### *Drover*

Handbrake	1985 on		<b>Handbrake</b>	<b>N3153</b>	180.0 x 29.0
4WD - Disc/Drum Some models	1985 on			<b>N1627</b>	220.0 x 39.0

### *Frontera*

4Cyl & V6	10/1995 on		<b>Handbrake</b>	<b>N3081</b>	210.0 x 32.0
-----------	------------	--	------------------	--------------	--------------

### *Gemini*

TX, TC, TD All Models	1975 - 78			<b>N1174</b>	228.6 x 44.4
Panel Van	1978 - 79			<b>N1174</b>	228.6 x 44.4
TD, TE, TF, TG 1.6L Petrol	1979 - 84			<b>N1385</b>	230.0 x 50.0
Panel Van	1980 - 84			<b>N1385</b>	230.0 x 50.0
TE, TF, TG 1.8L Diesel	1981 - 84			<b>N1579</b>	228.6 x 40.0
RB Front Wheel Drive	1985 - 87			<b>N1601</b>	180.0 x 25.0
Some Models	1985 - 87			<b>N1674</b>	180.0 x 30.0

### *Holden*

All Models to Engine No. 136884	1948 - 54	<b>N1171</b>	228.6 x 38.1	<b>N1171</b>	228.6 x 38.1
All Models from Engine No. 136885	1954 - 56	<b>N1171</b>	228.6 x 38.1	<b>N1173</b>	228.6 x 38.1
FE, FC All Models	1956 - 59	<b>N1175</b>	228.6 x 38.1	<b>N1175</b>	228.6 x 38.1
FB, EK All Models	1959 - 62	<b>N1176</b>	228.6 x 44.4	<b>N1176</b>	228.6 x 44.4
EJ, EH All Models	1962 - 65	<b>N1174</b>	228.6 x 44.4	<b>N1174</b>	228.6 x 44.4
HD, HR Drum/Drum	1965 - 68	<b>N1172</b>	228.6 x 57.1	<b>N1174</b>	228.6 x 44.4
HD, HR Disc/Drum	1965 - 68			<b>N1132</b>	228.6 x 44.4
HD, HR Ute Van Disc/Drum	1966 - 69			<b>N1130</b>	228.6 x 57.1
HK, HT, HG, HQ, HJ Drum/Drum	1968 - 71	<b>N1336</b>	254.0 x 57.1	<b>N1337</b>	254.0 x 44.4
HK, HT, HG Disc/Drum	1968 - 71			<b>N1338</b>	254.0 x 44.4
HQ - HZ Disc/Drum	1971 - 79			<b>N1337</b>	254.0 x 44.4
WB Ute Van Disc/Drum	1980 - 85			<b>N1337</b>	254.0 x 44.4

### *Jackaroo*

All Models with clips on brake shoe Platform	1981 - 83			<b>N1413</b>	254.0 x 50.0
All Models without clips on brake shoe Platform	1981 - 83			<b>N1402</b>	254.0 x 50.0
All Models Most	1984 - 3/87			<b>N1595</b>	254.0 x 50.8
All Models Some	1984 - 3/87			<b>N1662</b>	254.0 x 50.0
All Models Most	4/87 - 3/92			<b>N1595</b>	254.0 x 50.8
All Models Some	4/87 - 3/92			<b>N1662</b>	254.0 x 50.0

### *Nova*

LE 1.3, 1.4, 1.6L	7/1989 - 7/91			<b>N1602</b>	200.0 x 30.0
LF 1.6L Sedan & Hatchback	8/1991 - 8/94			<b>N1602</b>	200.0 x 30.0
LF 1.8L	8/1991 - 8/94			<b>N1602</b>	200.0 x 30.0
LG 1.6L	9/1994 on			<b>N3123</b>	200.0 x 30.0

### *Rodeo*

All Models	1981 - 83			<b>N1402</b>	254.0 x 50.0
------------	-----------	--	--	--------------	--------------



## HOLDEN

### Rodeo

All Models	4/1984 - 1987			<b>N1595</b>	254.0 x 50.8
All Models	1988 on			<b>N1662</b>	254.0 x 50.0
TF V6 2WD, 4 CYL & V6 4WD & R9	1997 - 03			<b>N3167</b>	295.0 x 45.0
RA With 254mm Rear Drums	3/2003 on			<b>N3007</b>	254.0 x 50.0
RA With 295mm Rear Drums	3/2003 on			<b>N3008</b>	295.0 x 45.0

### Scurry

SK410	1985 on			<b>N1624</b>	220.0 x 39.0
-------	---------	--	--	--------------	--------------

### Shuttle

All Models without clips on brake shoe platform	1982 on			<b>N1402</b>	254.0 x 50.0
All Models with clips on brake shoe Platform	1982 on			<b>N1413</b>	254.0 x 50.0

### Statesman

WB Banksia Park Brake	1980 - 84	<b>Major</b>	PBK217	<b>Minor</b>	PBK216
WH Banksia Park Brake	6/99 - 6/01	<b>Major</b>	PBK217	<b>Minor</b>	PBK216

### Suburban

1500, 2500 With 11" Rear Drum	1981 - 02			<b>N3171</b>	283.0 x 70.0
1500, 2500 With 13" x Rear Drum - Some	1981 - 02			<b>N3173</b>	330.2 x 89.0

### Sunbird

LX, UX With PBR Front Disc Brakes	1977 - 80			<b>N1174</b>	228.6 x 44.4
LX, UC with Girling Front Disc Brakes	1979 - 80			<b>N1385</b>	230.0 x 50.0

### Torana

HB, LC, LJ & TA With Front Discs & Girling Rear	1967 - 72			<b>N1260</b>	203.2 x 31.7
HB, LC, LJ & TA 4-cyl with front discs & Lockheed	1967 - 72			<b>N1357</b>	203.2 x 31.7
HB, LC, LJ 4 Cyl - Girling Drum/Drum Brakes	1967 - 72	<b>N1259</b>	203.2 x 31.7	<b>N1260</b>	203.2 x 31.7
LC, JL 6 Cyl	1969 - 72	<b>N1174</b>	228.6 x 44.4	<b>N1174</b>	228.6 x 44.4
LC, LJ & GTR XU1 Disc/Drum	1969 - 72			<b>N1132</b>	228.6 x 44.4
LJ, TA 4 Cyl with Lockheed Drum/Drum Brakes	1972 - 74	<b>N1357</b>	203.2 x 31.7	<b>N1357</b>	203.2 x 31.7
LJ, TA 4 Cyl with Front Disc & Adjusting Lockheed	1972 - 74			<b>N1374</b>	203.2 x 31.7
LH, LX 4 & 6 Cyl Disc/Drum	1974 - 76			<b>N1174</b>	228.6 x 44.4
LH, LX 4 & 6 Cyl Drum/Drum	1974 - 76	<b>N1174</b>	228.6 x 44.4	<b>N1174</b>	228.6 x 44.4
LH, LX 4 & 6 Cyl Disc/Drum	1974 - 78			<b>N1174</b>	228.6 x 44.4
LH V8	1974 - 76			<b>N1337</b>	254.0 x 44.4
UC With P.B.R. Front Disc Brakes	1978 - 80			<b>N1174</b>	228.6 x 44.4
UC With Girlock Front Disc Brakes	1978 - 80			<b>N1385</b>	230.0 x 50.0

### Zafira

Zafira	8/01 on			<b>N3196</b>	228.6 x 42.0
--------	---------	--	--	--------------	--------------



## HOLDEN

**N1130**

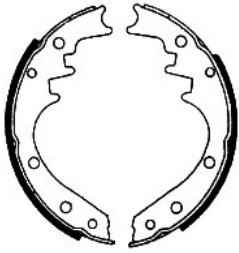

228.6 x 57.1

**N1132**

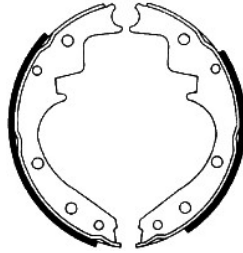

228.6 x 44.4

**N1171**

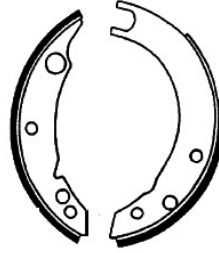

228.6 x 38.1

**N1172**

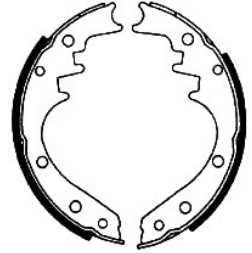

228.6 x 57.1

**N1173**

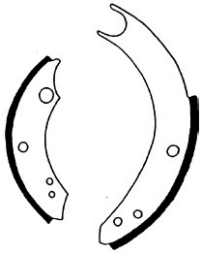

228.6 x 38.1

**N1174**

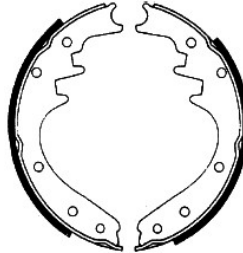

228.6 x 44.4

**N1175**

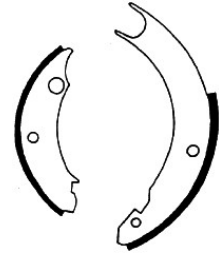

228.6 x 38.1

**N1176**

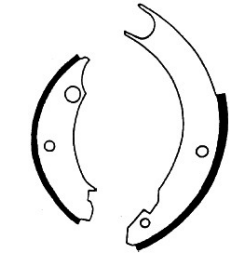

228.6 x 44.4

**N1259**

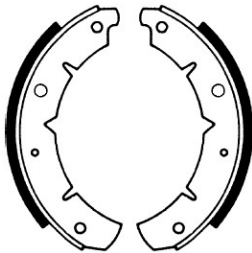

203.2 x 31.7

**N1260**

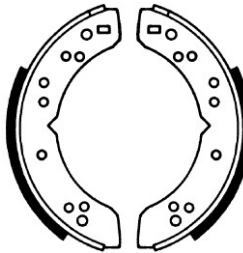

203.2 x 31.7

**N1336**

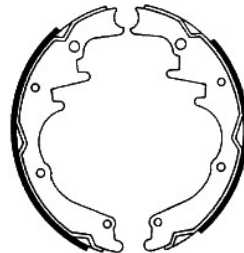

254.0 x 57.1

**N1337**

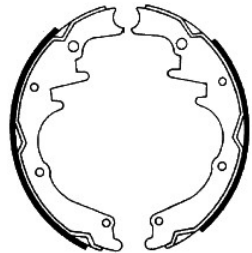

254.0 x 44.4

**N1338**

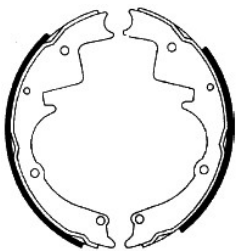

254.0 x 44.4

**N1357**

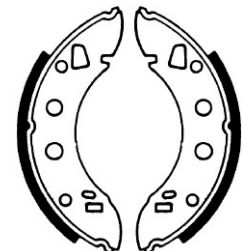

203.2 x 31.7

**N1374**

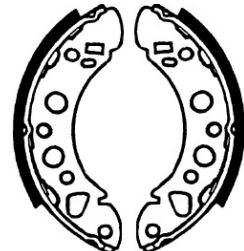

203.2 x 31.7

**N1385**

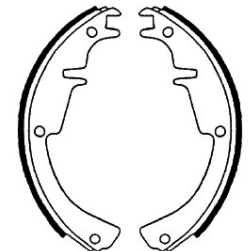

230.0 x 50.0



## HOLDEN

**N1399**

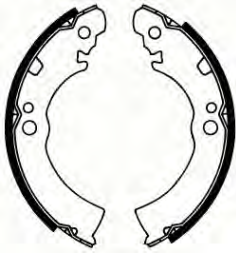

180.0 x 35.0

**N1402**

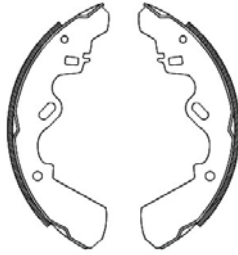

254.0 x 50.0

**N1412**

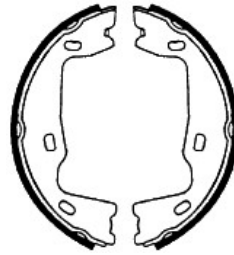

160.0 x 25.0

**N1413**

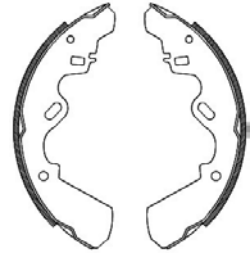

254.0 x 50.0

**N1539**

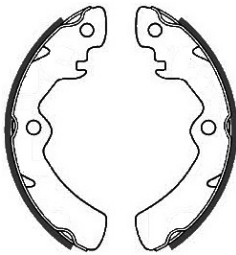

220.0 x 39.0

**N1579**

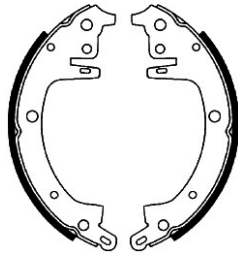

228.6 x 40.0

**N1595**

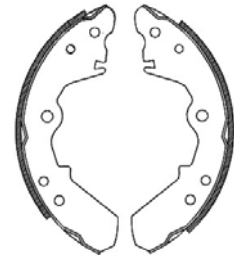

254.0 x 50.8

**N1598**

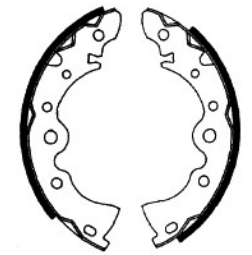

203.2 x 35.0

**N1601**

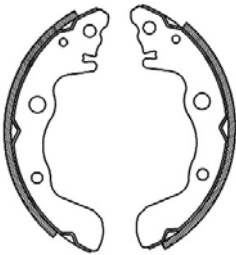

180.0 x 25.0

**N1602**

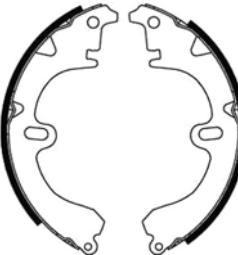

200.0 x 30.0

**N1616**

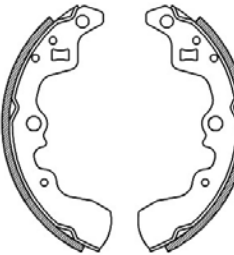

180.0 x 30.0

**N1624**

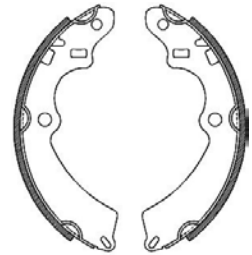

220.0 x 39.0

**N1628**

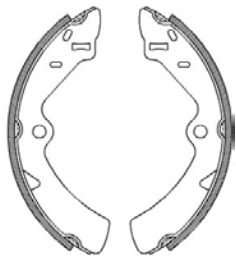

220.0 x 39.0

**N1659**

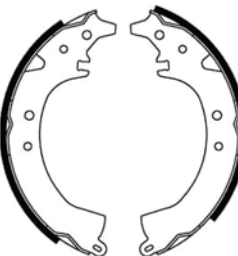

228.6 x 40.0

**N1662**

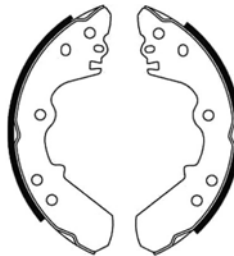

254.0 x 50.0

**N1669**

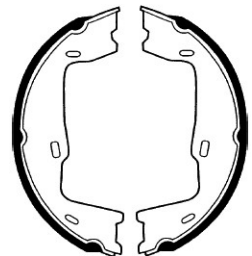

160.0 x 25.0





## HOLDEN

**N1672**



180.0 x 35.0

**N1674**

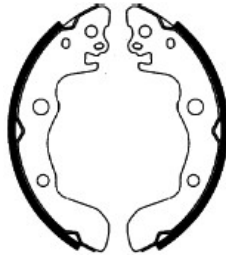

180.0 x 30.0

**N3007**

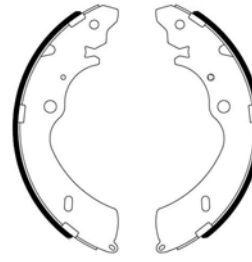

**N1824**  
254.0 x 50.0

**N3008**

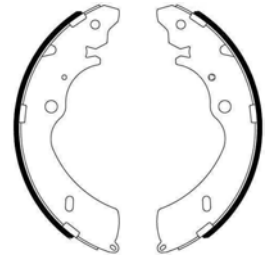

**N1793**  
295.0 x 45.0

**N3021**

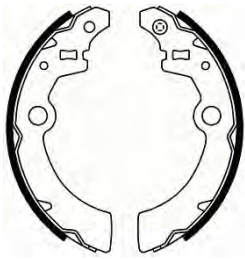

**N1820**  
180.0 x 25.0

**N3058**

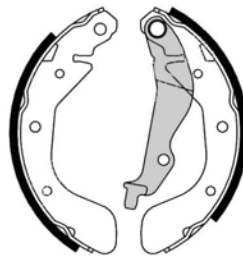

**N1870**  
200.0 x 36.1

**N3081**

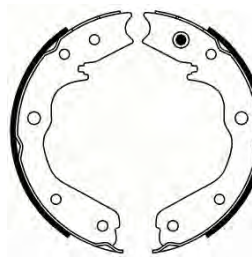

**N1838**  
210.0 x 32.0

**N3103**

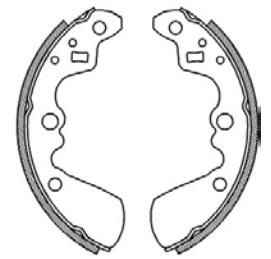

**N1684**  
180.0 x 25.0

**N3123**

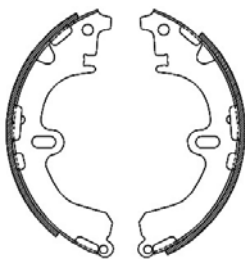

**N1704**  
200.0 x 30.0

**N3124**

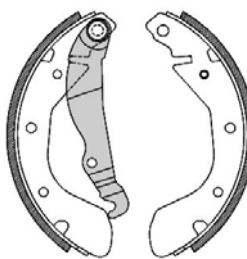

**N1705**  
200.0 x 29.0

**N3128**

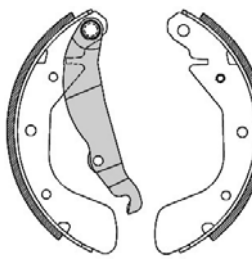

**N1710**  
200.0 x 45.0

**N3145**

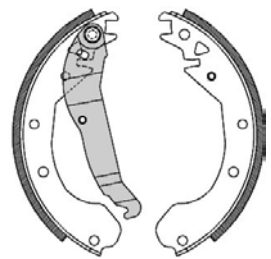

**N1732**  
230.0 x 50.0

**N3153**

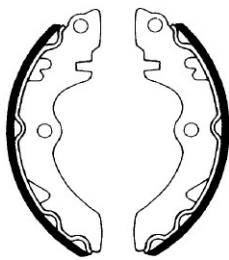

**N1740**  
180.0 x 29.0

**N3162**



**N1751**  
170.0 x 30.0

**N3167**



**N1757**  
295.0 x 45.0

**N3171**

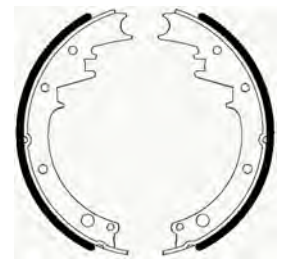

**N1761**  
283.0 x 70.0



## HOLDEN

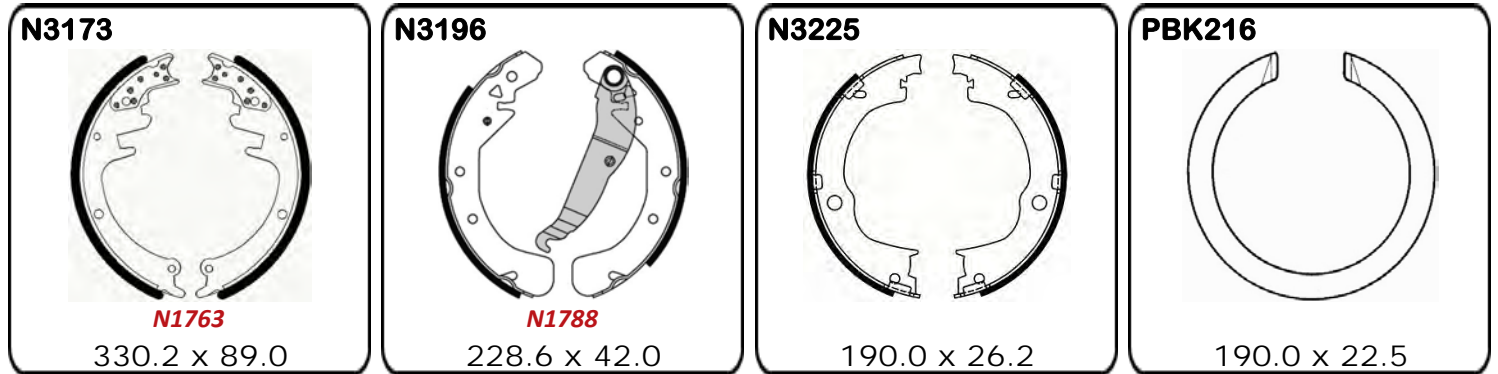

## HONDA

### Accord

SJ, SY 1599cc	1977 - 81			<b>N1397</b>	180.0 x 35.0
Sedan	1979 - 82			<b>N1397</b>	180.0 x 35.0
Sedan & Hatch 1602cc	1982 - 83			<b>N1525</b>	180.0 x 35.0
Sedan & Hatch 1829cc	1984 - 85			<b>N1613</b>	200.0 x 35.0
Sedan & Hatch 1995cc Carby	1986 - 89			<b>N1614</b>	200.0 x 35.0

### Acty & City

Pro-Wagon	1984 - 86			<b>N1615</b>	180.0 x 35.0
3 Door & Acty Van 1.2L	1984 - 86			<b>N1393</b>	180.0 x 25.0
Acty Van 545cc	1984 - 86			<b>N1352</b>	180.0 x 35.0

### Civic

Sedan & Hatch 1169 & 1237cc	1973 - 79			<b>N1352</b>	180.0 x 35.0
Sedan & Wagon 1488cc	1976 - 79			<b>N1600</b>	200.0 x 35.0
Wagon with Light Duty Rods 1335cc	1979 - 83			<b>N1393</b>	180.0 x 25.0
Wagon With Heavy Duty Rods 1335cc	1979 - 83			<b>N1650</b>	180.0 x 25.0
Hatch 1300cc	1980 - 83			<b>N1352</b>	180.0 x 35.0
Sedan 1300 & 1500cc	1982 - 83			<b>N1613</b>	200.0 x 35.0
Sedan CVCC 1488cc	1984 - 87			<b>N1397</b>	180.0 x 35.0
Hatch 1488cc	1984 - 87			<b>N1397</b>	180.0 x 35.0
Wagon With Light Duty Rods 1488cc	1984 - 86			<b>N1619</b>	200.0 x 25.0
Wagon With Heavy Duty Rods 1488cc	1984 - 86			<b>N1651</b>	200.0 x 25.0
AM, AG Series 1200 & 1300cc	1984 - 88			<b>N1610</b>	180.0 x 30.0
AH, AK Series 1500cc	1984 - 88			<b>N1610</b>	180.0 x 30.0





## HONDA

### *Civic*

ED, EE, EC Series	1988 - 92			<b>N1610</b>	180.0 x 30.0
EG, EH Series Alternate	1992 on			<b>N1614</b>	200.0 x 35.0
EG, EH Series	1992 on			<b>N3111</b>	180.0 x 30.0
EK1 4 Door Sedan 1.6L	1996 on			<b>N1614</b>	200.0 x 35.0

### *CR-V*

2.0L 4WD	10/1997 on			<b>N3174</b>	228.6 x 35.0
2.4L DOHC (2 Sets Needed per Vehicle)	12/01 - 9/06		<b>Handbrake</b>	<b>N3049</b>	170.0 x 34.0

### *HR-V*

4WD 1.6L Wagon	1/1999 on			<b>N1614</b>	200.0 x 35.0
----------------	-----------	--	--	--------------	--------------

### *Integra*

DA1, DA3, DA4 1500 & 1600cc	1986 - 89			<b>N1611</b>	200.0 x 30.0
-----------------------------	-----------	--	--	--------------	--------------

### *Jazz*

1.3 & 1.5L	2003 on			<b>N3005</b>	180.0 x 31.0
------------	---------	--	--	--------------	--------------

### *Legend*

3.5L 24V (2 Sets Needed per Vehicle)	5/96 - 1/01		<b>Handbrake</b>	<b>N3049</b>	170.0 x 34.0
--------------------------------------	-------------	--	------------------	--------------	--------------

### *Life*

Life	1972	<b>N1069</b>	180.0 x 35.0	<b>N1352</b>	180.0 x 35.0
------	------	--------------	--------------	--------------	--------------

### *Odyssey*

2.3L Handbrake Shoe (2 Sets Needed per Vehicle)	1997 on			<b>N3049</b>	170.0 x 34.0
---	---------	--	--	--------------	--------------

### *Prelude*

Coupe With Light Duty Rods 1.6L	1979 - 82			<b>N1393</b>	180.0 x 25.0
Coupe With Heavy Duty Rods 1.6L	1979 - 82			<b>N1650</b>	180.0 x 25.0
Coupe With Alternate Rear Drum Some	1982 - 86			<b>N1613</b>	200.0 x 35.0
Coupe With Alternate Rear Drum Some	1982 - 86			<b>N1619</b>	200.0 x 25.0

### *Scamp*

Scamp	1968 - 72	<b>N1069</b>	180.0 x 35.0	<b>N1069</b>	180.0 x 35.0
-------	-----------	--------------	--------------	--------------	--------------

### *TN360*

TN360	1969 - 78			<b>N1393</b>	180.0 x 25.0
-------	-----------	--	--	--------------	--------------

### *Z Series*

Z Series	1971 - 74			<b>N1352</b>	180.0 x 35.0
----------	-----------	--	--	--------------	--------------



## HONDA

**N1069**

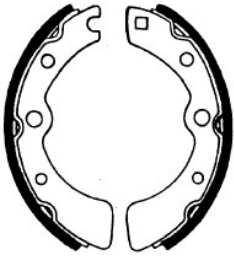

180.0 x 35.0

**N1352**

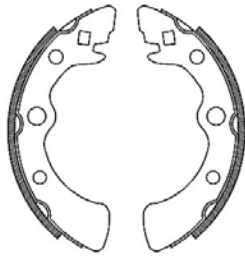

180.0 x 35.0

**N1393**

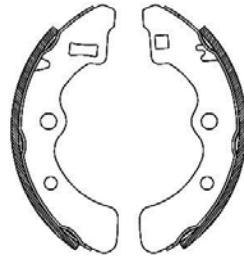

180.0 x 25.0

**N1397**

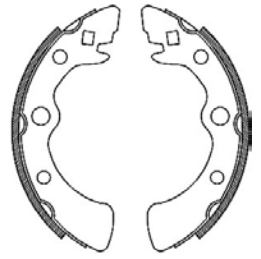

180.0 x 35.0

**N1525**

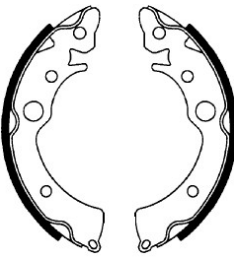

180.0 x 35.0

**N1600**

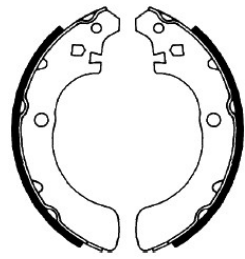

200.0 x 35.0

**N1610**

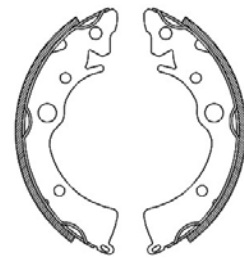

180.0 x 30.0

**N1611**

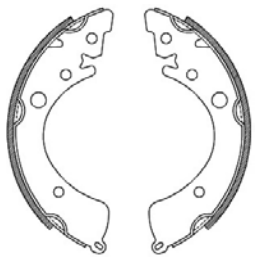

200.0 x 30.0

**N1613**

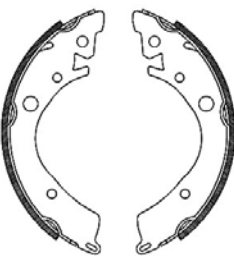

200.0 x 35.0

**N1614**

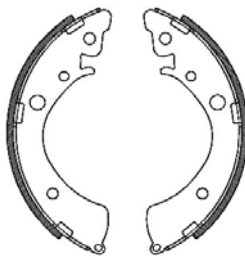

200.0 x 35.0

**N1615**

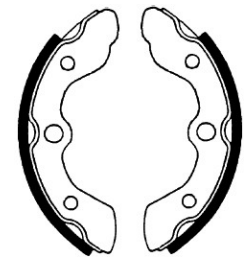

180.0 x 35.0

**N1619**

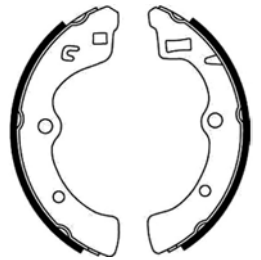

200.0 x 25.0

**N1650**



180.0 x 25.0

**N1651**

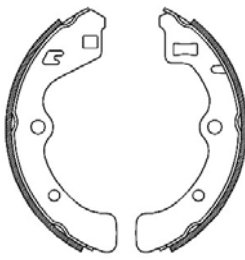

200.0 x 25.0

**N3005**

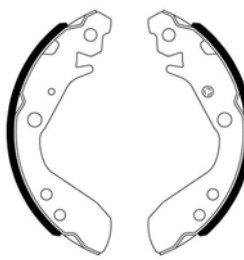

*N1849/BS5012*

180.0 x 31.0

**N3049**

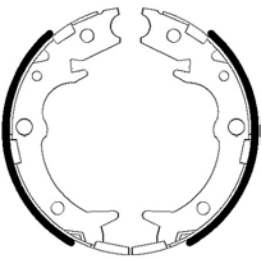

170.0 x 34.0



## HONDA

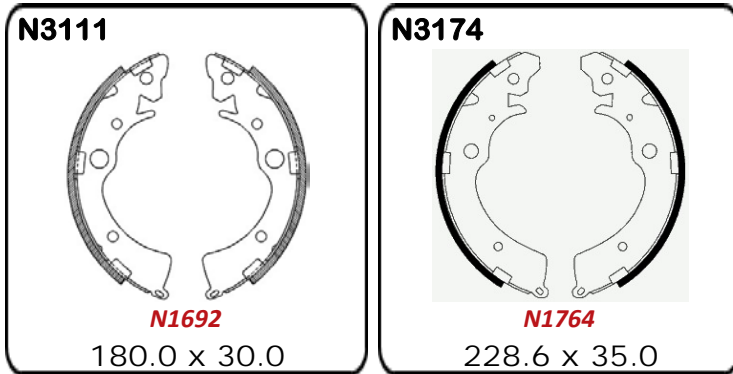

## HUMBER

<i>Hawk</i>					
Series I	1958 - 59	N1469	279.4 x 57.1	N1469	279.4 x 57.1
Series IA	1960 - 61	N1469	279.4 x 57.1	N1285	254.0 x 57.1
Series II & III	1962 on			N1027	279.4 x 57.1

<i>Super Snipe</i>					
Series I, II, III, IV & V	1959 on			N1027	279.4 x 57.1

<i>Vogue</i>					
MkI	1963	N1298	228.6 x 44.4	N1298	228.6 x 44.4
Sports, MkIII & MkIII	1963 on			N1298	228.6 x 44.4

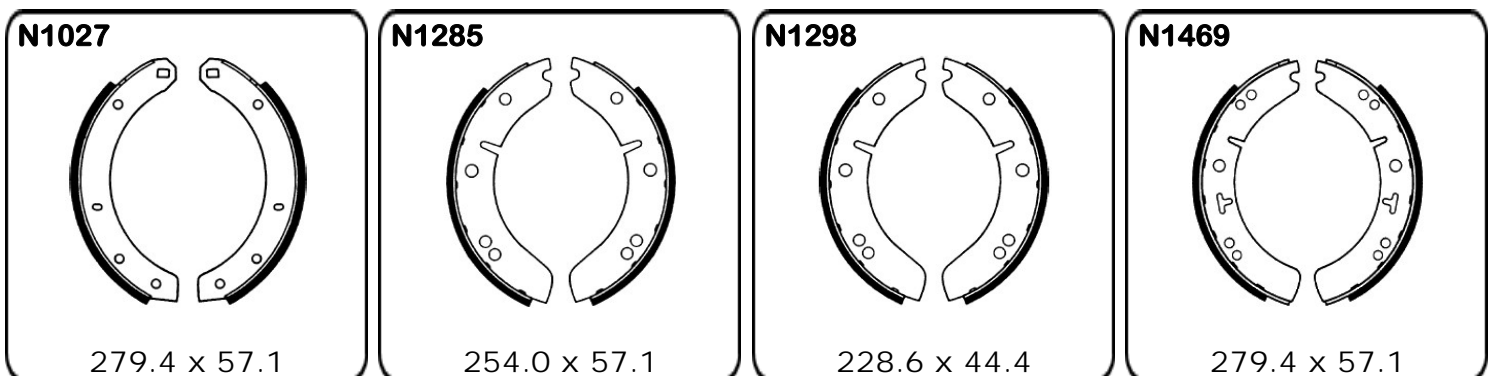



## HYUNDAI

### Accent

LC 1.5 Sedan & Hatch	6/00 - 2003			<b>N3001</b>	180.0 x 35.0
LC, LS 1.6L	2003 on			<b>N3048</b>	203.2 x 38.0

### Atoz

1.0L	11/1997 - 7/03			<b>N3152</b>	180.0 x 30.0
------	----------------	--	--	--------------	--------------

### Elantra

GLS 2.0 Sedan & Hatch	10/2000 on			<b>N3121</b>	203.2 x 38.5
-----------------------	------------	--	--	--------------	--------------

### Excel

All Models	1986 - 88			<b>N1398</b>	180.0 x 35.0
1.5 Sedan & Hatch	1989 - 91			<b>N1679</b>	180.0 x 34.0
Sedan & Hatch	1992 - 94			<b>N3114</b>	180.0 x 35.0
Sedan & Hatch	7/1994 on			<b>N3152</b>	180.0 x 30.0

### Getz

Getz	2002 on			<b>N3188</b>	180.0 x 30.0
------	---------	--	--	--------------	--------------

### Grandeur

XG	1998 - 05		<b>Handbrake</b>	<b>N3051</b>	168.0 x 31.5
TG	2005 on		<b>Handbrake</b>	<b>N3052</b>	190.0 x 31.8

### Lantra

Lantra	1992 - 4/93			<b>N3121</b>	203.2 x 38.5
Lantra	5/1993 - 94			<b>N3122</b>	203.2 x 38.5
Lantra	1995			<b>N3121</b>	203.2 x 38.5

### S Coupe

S Coupe	1991 - 92			<b>N1679</b>	180.0 x 34.0
S Coupe	1993 on			<b>N3114</b>	180.0 x 35.0

### Santa Fe

2.4L	2000 on			<b>N3190</b>	254.0 x 45.0
2.7L	2001 on		<b>Handbrake</b>	<b>N3087</b>	190.0 x 40.0

### Sonata

2.4 & 3.0L GL, GLS	1989 on			<b>N1675</b>	228.6 x 44.5
--------------------	---------	--	--	--------------	--------------

### Terracan

Terracan	2001 on			<b>N3187</b>	254.0 x 55.0
----------	---------	--	--	--------------	--------------

### Trajt

Trajt	2000 on			<b>N3187</b>	254.0 x 55.0
-------	---------	--	--	--------------	--------------

# Brake Shoe Catalogue



## HYUNDAI

**N1398**

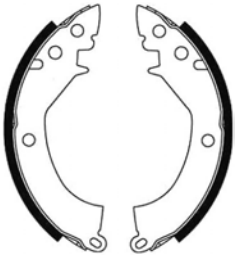

180.0 x 35.0

**N1675**

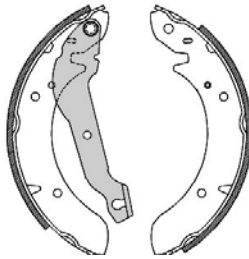

228.6 x 44.5

**N1679**

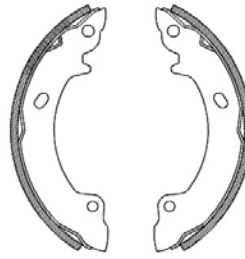

180.0 x 34.0

**N3001**

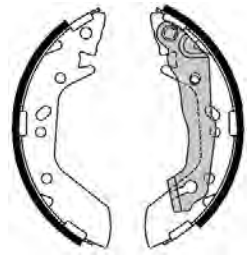

**N1779**

180.0 x 35.0

**N3048**

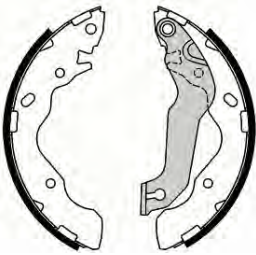

203.2 x 38.0

**N3051**

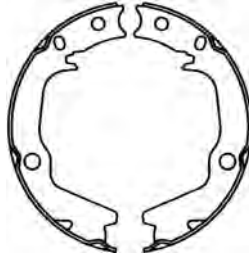

168.0 x 31.5

**N3052**

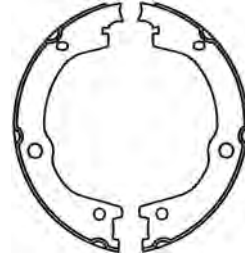

190.0 x 31.8

**N3087**

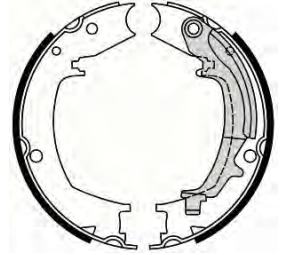

**N1866**

190.0 x 40.0

**N3114**

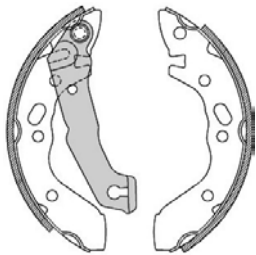

**N1695**

180.0 x 35.0

**N3121**

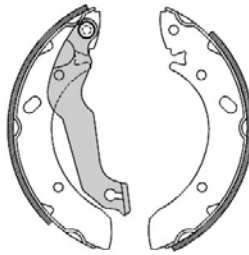

**N1702**

203.2 x 38.5

**N3122**

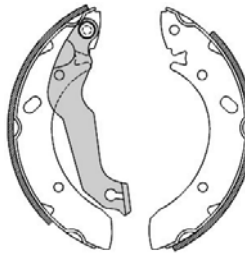

**N1703**

203.2 x 38.5

**N3152**

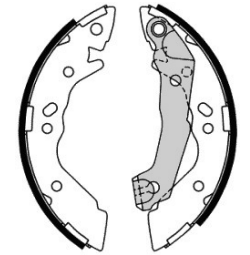

**N1739**

180.0 x 30.0

**N3187**

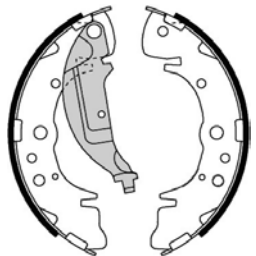

**N1778**

254.0 x 55.0

**N3188**



**N1780**

180.0 x 30.0

**N3190**

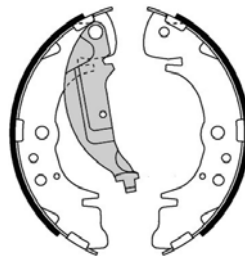

**N1782**

254.0 x 45.0



## INTERNATIONAL

### International

AA110, AA112 Series	1950 - 64	<b>N1194</b>	304.8 x 44.4	<b>N1194</b>	304.8 x 44.4
AA120, AA130, AA148	1950 - 64	<b>N1194</b>	304.8 x 44.4		
C1200, 1300 Some	1966	<b>N1194</b>	304.8 x 44.4		

**N1194**

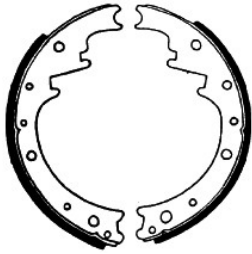

304.8 x 44.4

## ISUZU

### Bellet

1500	1964 - 71	<b>N1229</b>	203.2 x 38.1	<b>N1230</b>	203.2 x 38.1
------	-----------	--------------	--------------	--------------	--------------

### C Series

CVS, CXW, CYJ, CYL,, CYM, CVW	5/87 on		<b>Handbrake</b>	<b>N3080</b>	304.8 x 75.0
-------------------------------	---------	--	------------------	--------------	--------------

### D-Max

4x2 & 4x4	08 on			<b>N3008</b>	295.0 x 45.0
-----------	-------	--	--	--------------	--------------

### ELF Series

250 2000Kg TLG21, TLG50, TLG52, TLG63D	1967 - 75	<b>N1554</b>	300.0 x 55.0	<b>N1554</b>	300.0 x 55.0
150 2000Kg, KA40, KA41	1971 - 75	<b>N1552</b>	279.0 x 60.0	<b>N1553</b>	279.0 x 60.0
Handbrake	1972 - 75		<b>Handbrake</b>	<b>N1556</b>	178.0 x 35.0
250 2000Kg, TLG22	1972 - 75	<b>N1554</b>	300.0 x 55.0	<b>N1551</b>	228.6 x 75.0

### Florian

Florian	1966 - 71	<b>N1038</b>	228.0 x 40.0	<b>N1039</b>	228.0 x 40.0
---------	-----------	--------------	--------------	--------------	--------------

### JBR, JCR, JDR, SBR, SCR

Handbrake			<b>Handbrake</b>	<b>N3135</b>	216.0 x 50.0
-----------	--	--	------------------	--------------	--------------

### K Series

KS21, KS22, KS32	1979 - 85	<b>N1663</b>	320.0 x 75.0	<b>N1663</b>	320.0 x 75.0
KT25, KT26	1982 - 85	<b>N1555</b>	300.0 x 75.0	<b>N1555</b>	300.0 x 75.0



# Brake Shoe Catalogue



## ISUZU

### *K Series*

Handbrake			<b>Handbrake</b>	<b>N1556</b>	178.0 x 35.0
-----------	--	--	------------------	--------------	--------------

### *KB*

LUV Drum/Drum	1972 - 79	<b>N1365</b>	254.0 x 50.8	<b>N1366</b>	254.0 x 44.4
Disc/Drum	1977 - 79			<b>N1366</b>	254.0 x 44.4

### *KT Series*

All Models	1980 - 84	<b>N1550</b>	300.0 x 75.0	<b>N1551</b>	228.6 x 75.0
Handbrake	1980 - 84		<b>Handbrake</b>	<b>N1556</b>	178.0 x 35.0

### *LV Series*

With 304.8mm Drum	4/86 on		<b>Handbrake</b>	<b>N3080</b>	304.8 x 75.0
-------------------	---------	--	------------------	--------------	--------------

### *N Series*

NPR59	8/1985 - 87	<b>N1663</b>	320.0 x 75.0	<b>N1663</b>	320.0 x 75.0
NKR 57L, NPR 57L	1985 - 87	<b>N1555</b>	300.0 x 75.0	<b>N1555</b>	300.0 x 75.0
NPR57	8/1985 - 87	<b>N1550</b>	300.0 x 75.0	<b>N1550</b>	300.0 x 75.0
NPR59P, PJ, PR, NPR59LT	1986 - 88	<b>N1663</b>	320.0 x 75.0	<b>N1663</b>	320.0 x 75.0
NKR 33 Diesel	1987	<b>N1554</b>	300.0 x 55.0	<b>N1551</b>	228.6 x 75.0
NPR Series with 178mm drum Handbrake	1987 on		<b>Handbrake</b>	<b>N1556</b>	178.0 x 35.0
NPR Series with 190mm drum Handbrake	1987 on		<b>Handbrake</b>	<b>N3136</b>	190.0 x 45.0
NKR Series Handbrake	6/87 - 4/90		<b>Handbrake</b>	<b>N1556</b>	178.0 x 35.0
NPR With 4JB1 2.8L, 4BC2 3.3.L & 4BE1 3.6L Eng	2/1987 - 90	<b>N1550</b>	300.0 x 75.0	<b>N1550</b>	300.0 x 75.0
NPR With BD1 39L Eng	2/1987 - 90	<b>N1663</b>	320.0 x 75.0	<b>N1663</b>	320.0 x 75.0
NKR200, NKR250, NKR58	1988 on	<b>N1555</b>	300.0 x 75.0	<b>N1555</b>	300.0 x 75.0
NPR300	1988 on	<b>N1555</b>	300.0 x 75.0	<b>N1555</b>	300.0 x 75.0
NPR400	1988 on	<b>N1663</b>	320.0 x 75.0	<b>N1663</b>	320.0 x 75.0
NKR150	1988 on	<b>N1554</b>	300.0 x 55.0	<b>N1554</b>	300.0 x 55.0
NPR 4BC2 3.3L 16" Wheels & Auto Adjusters Some	7/1988 - 90	<b>N3146</b>	320.0 x 75.0	<b>N3146</b>	320.0 x 75.0
NPR MINI BUS with 4BD1 39L Eng	7/1988 - 90	<b>N3146</b>	320.0 x 75.0	<b>N3146</b>	320.0 x 75.0
NKR except MS5S Transmission Handbrake	5/90 - 11/93		<b>Handbrake</b>	<b>N3136</b>	190.0 x 45.0
NKR with MS5S Transmission Handbrake	5/90 - 11/93		<b>Handbrake</b>	<b>N1556</b>	178.0 x 35.0
NPR With 4BD1 3.9L Eng - Most	5/1990 on	<b>N1663</b>	320.0 x 75.0	<b>N1663</b>	320.0 x 75.0
NPR with 4BE1 3.6L Eng - Most	5/1990 on	<b>N1550</b>	300.0 x 75.0	<b>N1550</b>	300.0 x 75.0
NPR With 4BE1 3.6L Eng - Some	12/1991 on	<b>N3146</b>	320.0 x 75.0	<b>N3146</b>	320.0 x 75.0
NPR With 4HF1 4.2L Eng	7/1991 on	<b>N3146</b>	320.0 x 75.0	<b>N3146</b>	320.0 x 75.0
NPR59 - NPR400	12/1991 on	<b>N3047</b>	320.0 x 100.0	<b>N3047</b>	320.0 x 100.0
NPR66 - NPR400	1991 - 02	<b>N3047</b>	320.0 x 100.0	<b>N3047</b>	320.0 x 100.0
NPR - Most	12/1993 on	<b>N3146</b>	320.0 x 75.0	<b>N3146</b>	320.0 x 75.0
NPR With 4BD1 3.9L Eng - Some	5/1993 on	<b>N3146</b>	320.0 x 75.0	<b>N3146</b>	320.0 x 75.0
NPR Series With 203.2mm Drum	12/93 on		<b>Handbrake</b>	<b>N3077</b>	203.2 x 50.0
NKR with MSB5M & MSB5S Trans Handbrake	12/93 on		<b>Handbrake</b>	<b>N1556</b>	178.0 x 35.0
NKR with MXA5R & MSA5G Trans Handbrake	12/93 on		<b>Handbrake</b>	<b>N3136</b>	190.0 x 45.0



## ISUZU

### N Series

NPS66	1994 - 97			<b>N3047</b>	320.0 x 100.0
NPS71	1997 - 03			<b>N3047</b>	320.0 x 100.0
NPR71 - NPR400	1998 - 02	<b>N3047</b>	320.0 x 100.0	<b>N3047</b>	320.0 x 100.0
NQR70 With 4HE1-T Engine	1998 - 02		<b>Handbrake</b>	<b>N3226</b>	203.2 x 50.0
NQR70 - NQR450	1998 - 02	<b>N3228</b>	320.0 x 120.0	<b>N3228</b>	320.0 x 120.0
NPR70 All Models	2000 on	<b>N3047</b>	320.0 x 100.0	<b>N3047</b>	320.0 x 100.0

### TLD24

2000KG	1980 - 81	<b>N1554</b>	300.0 x 55.0	<b>N1551</b>	228.6 x 75.0
2000KG	1982 - 84	<b>N1555</b>	300.0 x 75.0	<b>N1555</b>	300.0 x 75.0
2000KG	1980 - 84		<b>Handbrake</b>	<b>N1556</b>	178.0 x 35.0

### TLD44

2500KG	1981 - 82	<b>N1554</b>	300.0 x 55.0	<b>N1554</b>	300.0 x 55.0
2500KG	1982 - 84	<b>N1555</b>	300.0 x 75.0	<b>N1555</b>	300.0 x 75.0
2500KG	1980 - 84		<b>Handbrake</b>	<b>N1556</b>	178.0 x 35.0

### TLD54

2000KG	1983 - 84	<b>N1555</b>	300.0 x 75.0	<b>N1555</b>	300.0 x 75.0
2000KG	1980 - 84		<b>Handbrake</b>	<b>N1556</b>	178.0 x 35.0

### TLD56

2750KG	1983 - 84	<b>N1555</b>	300.0 x 75.0	<b>N1555</b>	300.0 x 75.0
2750KG	1980 - 84		<b>Handbrake</b>	<b>N1556</b>	178.0 x 35.0

### Wasp

1000kg Series II KR10	1967 - 68		<b>Handbrake</b>	<b>N1556</b>	178.0 x 35.0
-----------------------	-----------	--	------------------	--------------	--------------

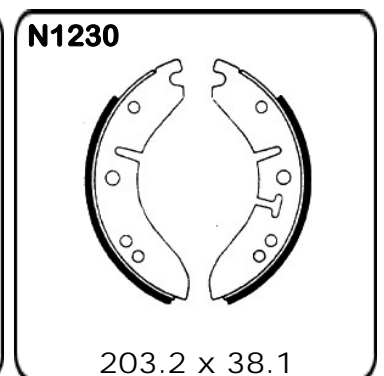
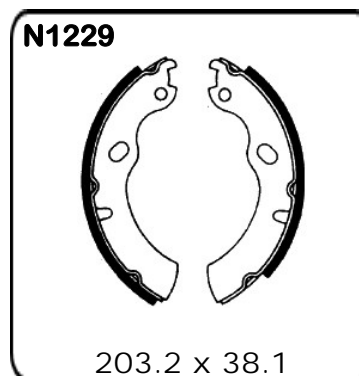
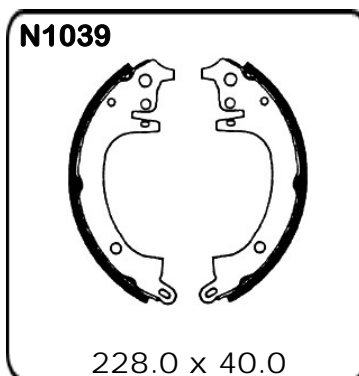
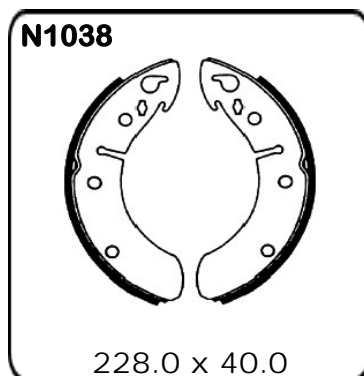



## ISUZU

**N1365**

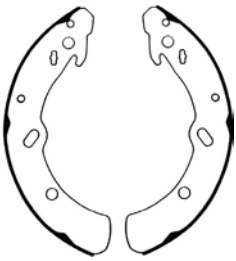

254.0 x 50.8

**N1366**

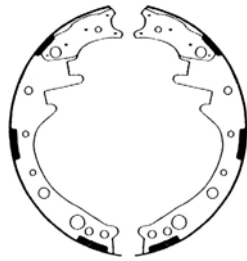

254.0 x 44.4

**N1549**

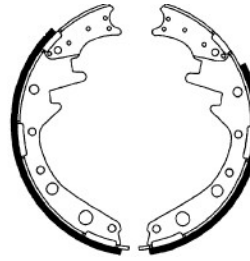

254.0 x 50.0

**N1550**

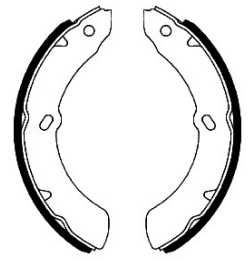

300.0 x 75.0

**N1551**

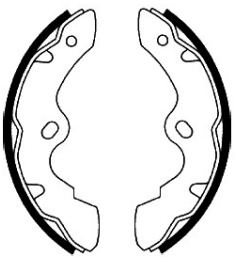

228.6 x 75.0

**N1552**

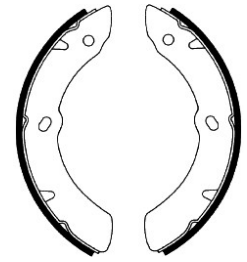

279.0 x 60.0

**N1553**

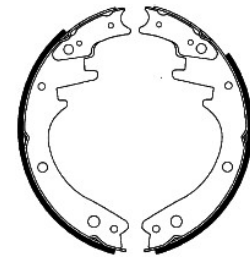

279.0 x 60.0

**N1554**

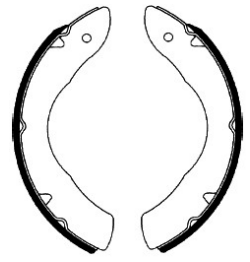

300.0 x 55.0

**N1555**

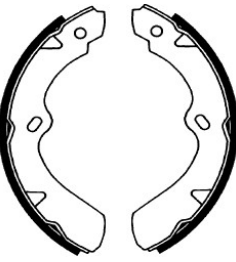

300.0 x 75.0

**N1556**

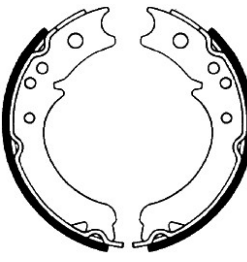

178.0 x 35.0

**N1663**

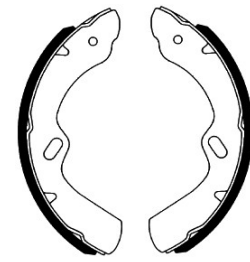

320.0 x 75.0

**N3008**

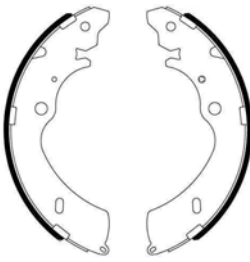

**N1793**

295.0 x 45.0

**N3047**

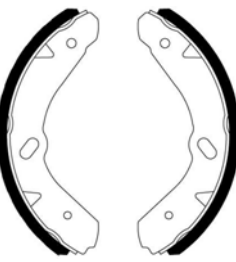

**N1850/BS5013**

320.0 x 100.0

**N3077**

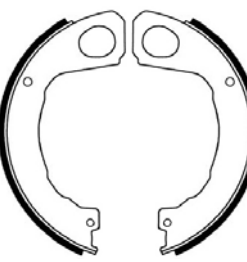

**N1833**

203.2 x 50.0

**N3080**

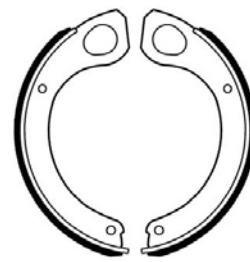

**N1836**

304.8 x 75.0

**N3135**

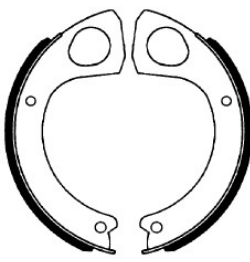

**N1717**

216.0 x 50.0



## ISUZU

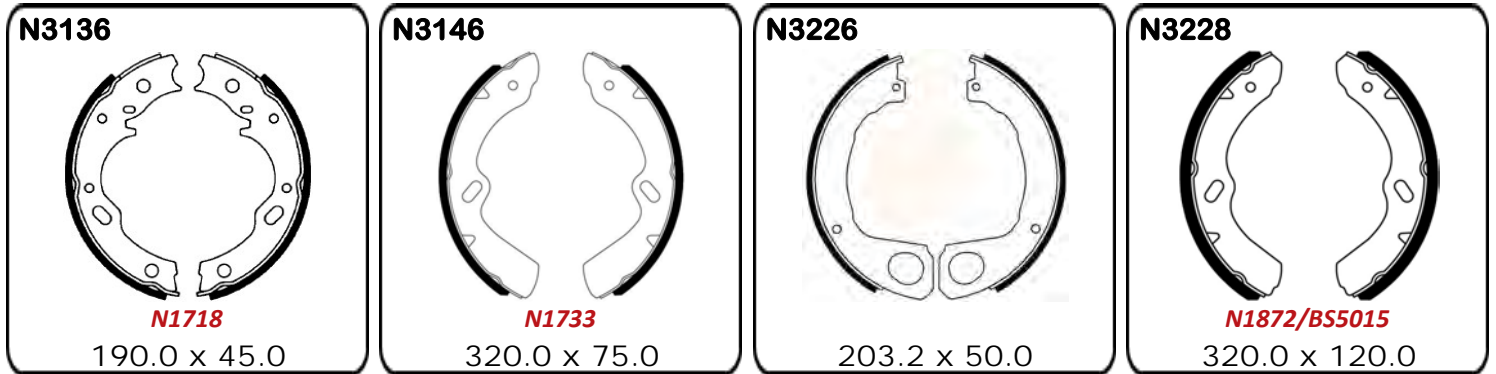

## IVECO

### Daily

Various With 172 x 42 Shoes	1/92 on		<b>Handbrake</b>	<b>N3214</b>	172.0 x 42.0
Various With 190 x 42 Shoes	1/92 on		<b>Handbrake</b>	<b>N3224</b>	190.0 x 42.0

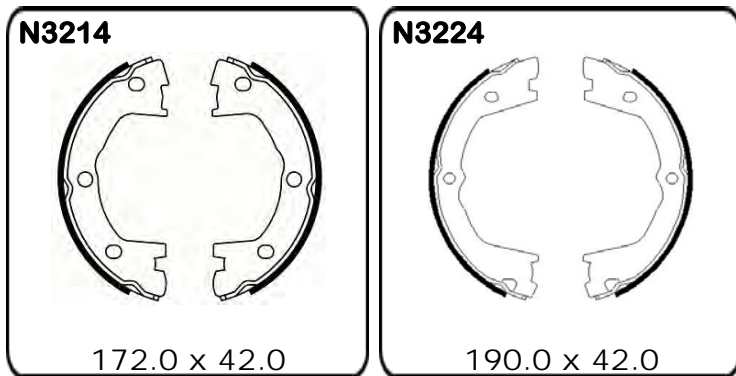

## JEEP

### Cherokee

Cherokee	1977 - 89			<b>N1529</b>	279.4 x 50.8
2WD & 4WD	1990			<b>N3133</b>	228.6 x 63.5



## JEEP

### Cherokee

2WD & 4WD	1990 - 93			<b>N3133</b>	228.6 x 63.5
With 9" Rear Brakes	1994 - 00			<b>N3133</b>	228.6 x 63.5
With 10" Rear Brakes	1994 - 00			<b>N3134</b>	254.0 x 44.5

### CJ Series

CJ5, CJ6	1967 - 68	<b>N1472</b>	228.6 x 44.4	<b>N1472</b>	228.6 x 44.4
CJ5, CJ6	1969 - 71	<b>N1184</b>	254.0 x 50.8	<b>N1184</b>	254.0 x 50.8
CJ5, CJ6	1972 - 77	<b>N1470</b>	279.4 x 50.8	<b>N1470</b>	279.4 x 50.8
CJ5, CJ7	1978 - 81			<b>N1471</b>	254.0 x 44.4
CJ5, CJ7, CJ8 Scrambler	1982 - 86			<b>N1471</b>	254.0 x 44.4

### Grand Cherokee

Grand Wagoneer	1984 - 86			<b>N1529</b>	279.4 x 50.8
Grand Wagoneer	1987 - 91			<b>N1529</b>	279.4 x 50.8
Grand Cherokee	1992 - 94			<b>N3134</b>	254.0 x 44.5
XJ	1994 - 99		<b>Handbrake</b>	<b>N3022</b>	184.0 x 30.0
WJ	11/99 - 04		<b>Handbrake</b>	<b>N3091</b>	194.0 x 30.0

### J Series

J20	1974 - 87			<b>N1528</b>	304.8 x 63.5
J10	1978 - 87			<b>N1529</b>	279.4 x 50.8

### Renegade

With 10" Rear Brakes	1982 - 84			<b>N1471</b>	254.0 x 44.4
With 11" Rear Brakes	1982 - 84			<b>N1529</b>	279.4 x 50.8

### Wagoneer

Wagoneer	1977 - 89			<b>N1529</b>	279.4 x 50.8
2WD & 4WD	1990			<b>N3133</b>	228.6 x 63.5

### Wrangler

Wrangler	1987 - 89			<b>N1471</b>	254.0 x 44.4
Wrangler	1990 on			<b>N3133</b>	228.6 x 63.5

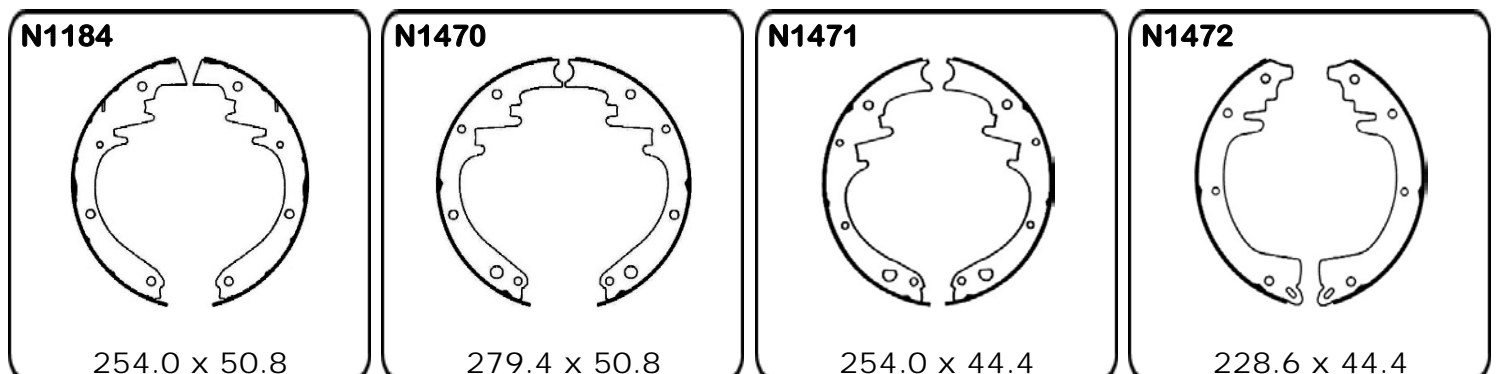



## JEEP

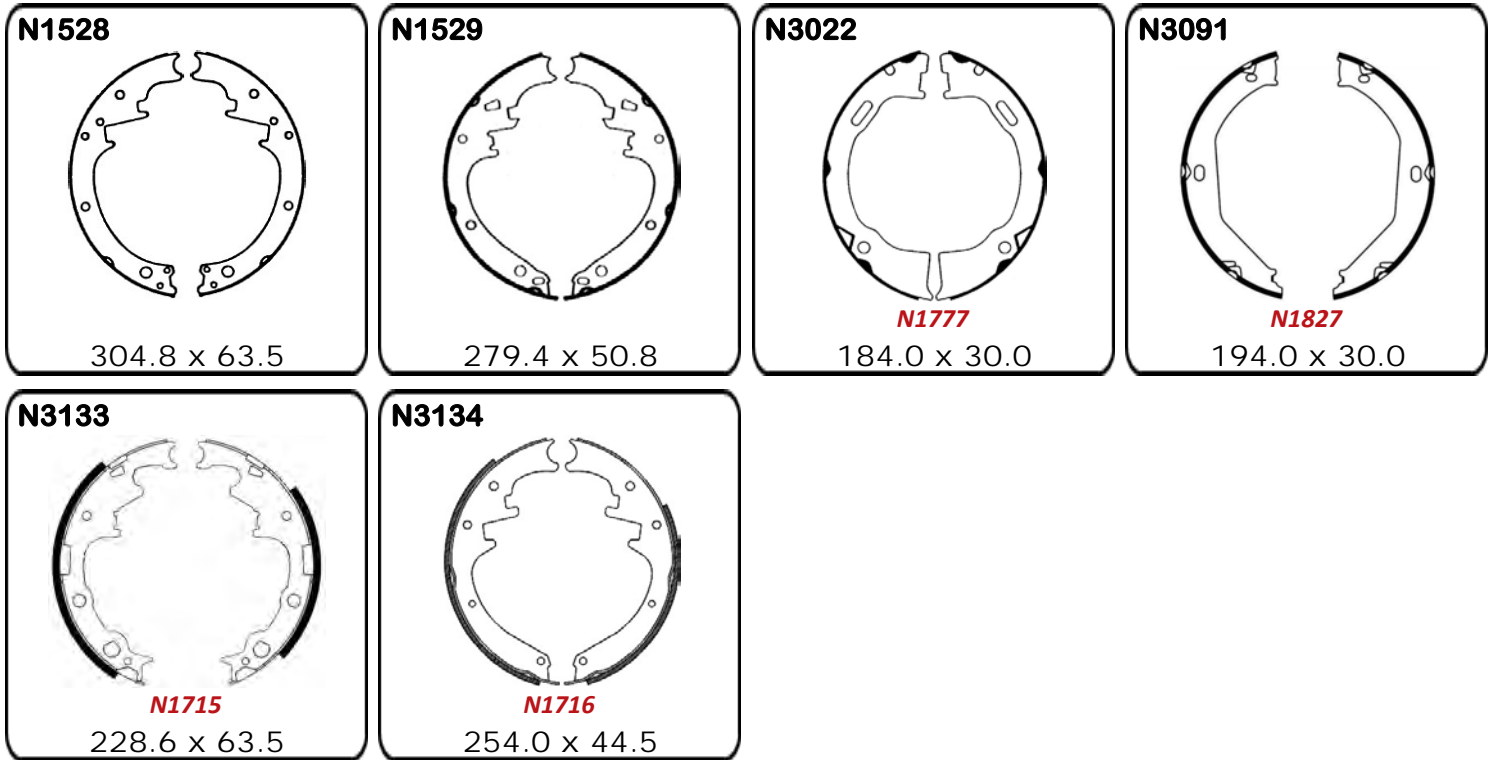

## KIA

### Carens

1.8L	2000 - 02			<b>N3062</b>	228.6 x 32.0
------	-----------	--	--	--------------	--------------

### Carnival

2.5L	1999 - 03			<b>N3166</b>	250.0 x 55.0
2.5L	2001 - 02			<b>N3187</b>	254.0 x 55.0
GQ	12/03 - 11/05			<b>N3229</b>	295.0 x 53.0
VQ	11/05 on		<b>Handbrake</b>	<b>N3230</b>	190.0 x 31.0

### Ceres

2.4L Diesel	1997 - 00	<b>N3066</b>	260.0 x 54.0	<b>N1389</b>	260.0 x 45.0
2.4L Diesel Some	1997 - 00	<b>N3066</b>	260.0 x 54.0	<b>N1587</b>	260.0 x 50.0

### K2700

2.7L	1998 on			<b>N3015</b>	220.0 x 55.0
------	---------	--	--	--------------	--------------



# Brake Shoe Catalogue



## KIA

### Mentor

1.5L, 1.8L	1996 - 97			<b>N3163</b>	200.0 x 35.0
1.5L, 1.8L	9/97 - 12/00			<b>N3189</b>	200.0 x 35.0

### Pregio

2.7L	2002 on			<b>N1587</b>	260.0 x 50.0
------	---------	--	--	--------------	--------------

### Rio

1.5L	2000 - 03			<b>N3003</b>	200.0 x 25.0
1.5L	2003 - 05			<b>N3067</b>	200.0 x 31.0
1.6L	2006 on			<b>N3070</b>	203.2 x 31.5

### Shuma

1.6 & 1.8L	10/97 - 5/04			<b>N3189</b>	200.0 x 35.0
------------	--------------	--	--	--------------	--------------

### Sorento

Wagon	02 - 06		<b>Handbrake</b>	<b>N3231</b>	190.0 x 40.0
-------	---------	--	------------------	--------------	--------------

### Spectra

1.8L	2001 on			<b>N3189</b>	200.0 x 35.0
------	---------	--	--	--------------	--------------

### Sportage

2.0L	1996 - 98			<b>N3164</b>	250.0 x 55.0
2.0L	1998 on			<b>N3185</b>	260.0 x 45.0
2.7L	2005 on		<b>Handbrake</b>	<b>N3087</b>	190.0 x 40.0

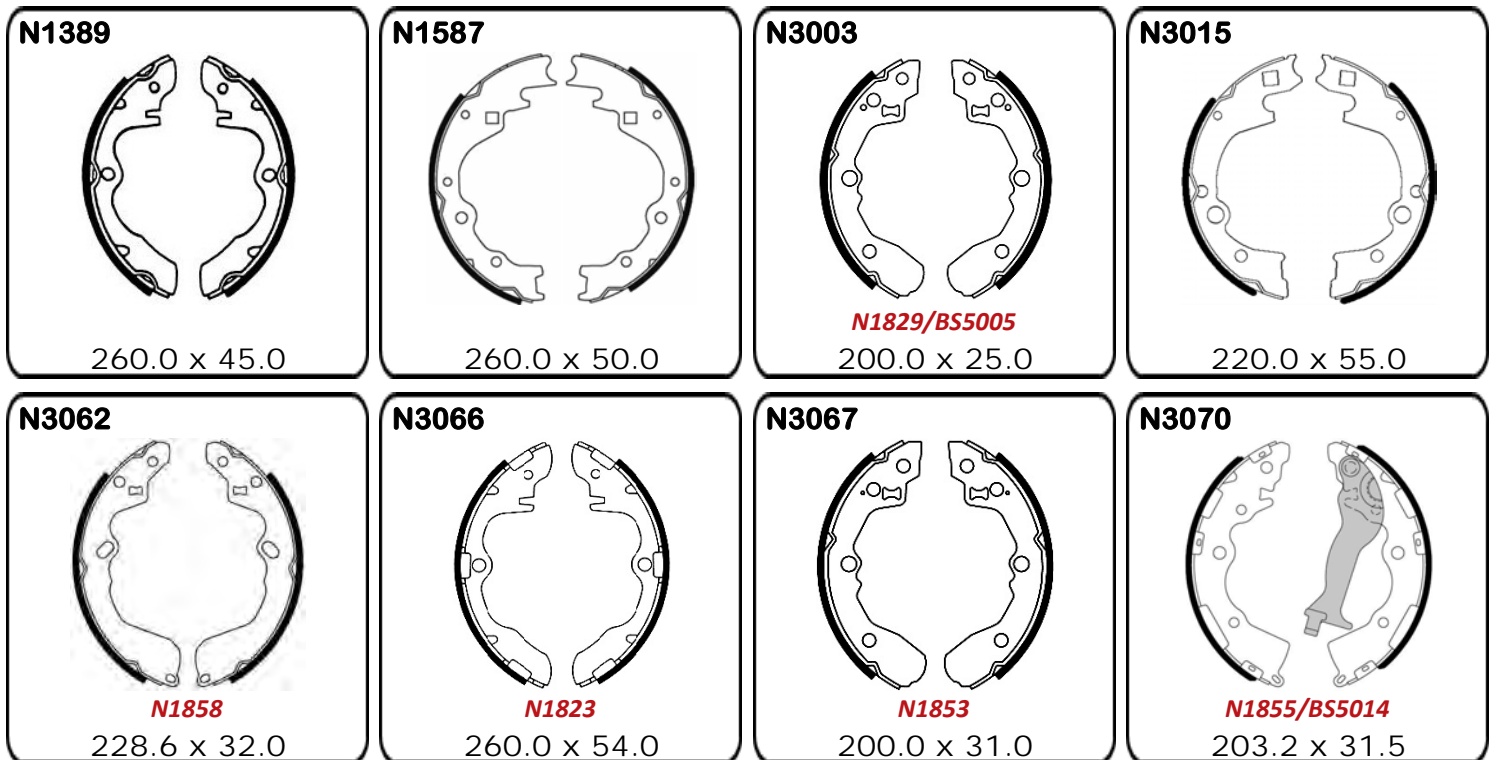



## KIA

<p><b>N3087</b></p> <p><b>N1866</b></p> <p>190.0 x 40.0</p>	<p><b>N3163</b></p> <p><b>N1753</b></p> <p>200.0 x 35.0</p>	<p><b>N3164</b></p> <p><b>N1754</b></p> <p>250.0 x 55.0</p>	<p><b>N3166</b></p> <p><b>N1756</b></p> <p>250.0 x 55.0</p>
<p><b>N3185</b></p> <p><b>N1775</b></p> <p>260.0 x 45.0</p>	<p><b>N3187</b></p> <p><b>N1778</b></p> <p>254.0 x 55.0</p>	<p><b>N3189</b></p> <p><b>N1781</b></p> <p>200.0 x 35.0</p>	<p><b>N3229</b></p> <p><b>N1895</b></p> <p>295.0 x 53.0</p>
<p><b>N3230</b></p> <p><b>N1894</b></p> <p>190.0 x 31.0</p>	<p><b>N3231</b></p> <p>190.0 x 40.0</p>		

## LADA

### Niva

Niva	1983 on		<b>N1473</b>	250.0 x 50.0
------	---------	--	--------------	--------------



## LADA

### Samara

Samara	1987 on			<b>N1661</b>	200.0 x 40.0
--------	---------	--	--	--------------	--------------

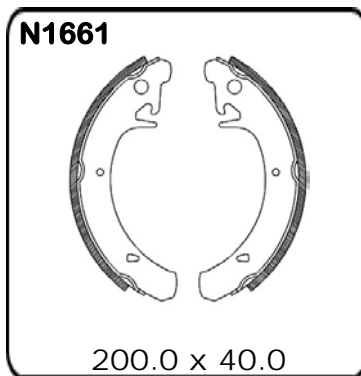
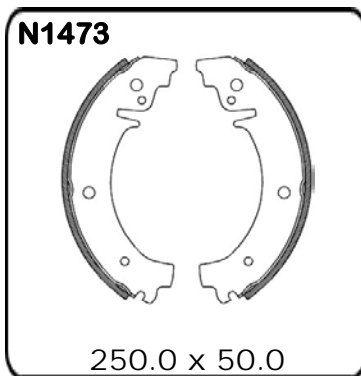

## LANDROVER

### Freelander

1.8L & 2.0TD	10/1997 - 9/00			<b>N3013</b>	254.0 x 39.0
1.8L, 2.0TD & 2.5V6	10/2000 on			<b>N3014</b>	254.0 x 44.5

### Landrover

88 Series II & III	1959 - 80	<b>N1417</b>	254.0 x 38.1	<b>N1417</b>	254.0 x 38.1
With V8 or Isuzu Engine Handbrake	1961 on		<b>Handbrake</b>	<b>N1422</b>	184.1 x 76.2
109 Series II, III 2.0 & 2.25L	1961 - 83	<b>N1420</b>	279.4 x 57.1	<b>N1092</b>	279.4 x 57.1
All except V8 & Isuzu Engine Handbrake	1961 on		<b>Handbrake</b>	<b>N1418</b>	228.6 x 44.4
109 Series II, III 2.6, 3.9L, V8	1967 - 84	<b>N1421</b>	279.4 x 76.2	<b>N1092</b>	279.4 x 57.1
110 Series	1984 - 85			<b>N1092</b>	279.4 x 57.1
110 Series	1986 on			<b>N3117</b>	279.4 x 57.1
With Isuzu 2.5L diesel Engine Handbrake	1989 on		<b>Handbrake</b>	<b>N1655</b>	254.0 x 70.0

### Range Rover

Handbrake	1990 on		<b>Handbrake</b>	<b>N1422</b>	184.1 x 76.2
-----------	---------	--	------------------	--------------	--------------



## LANDROVER

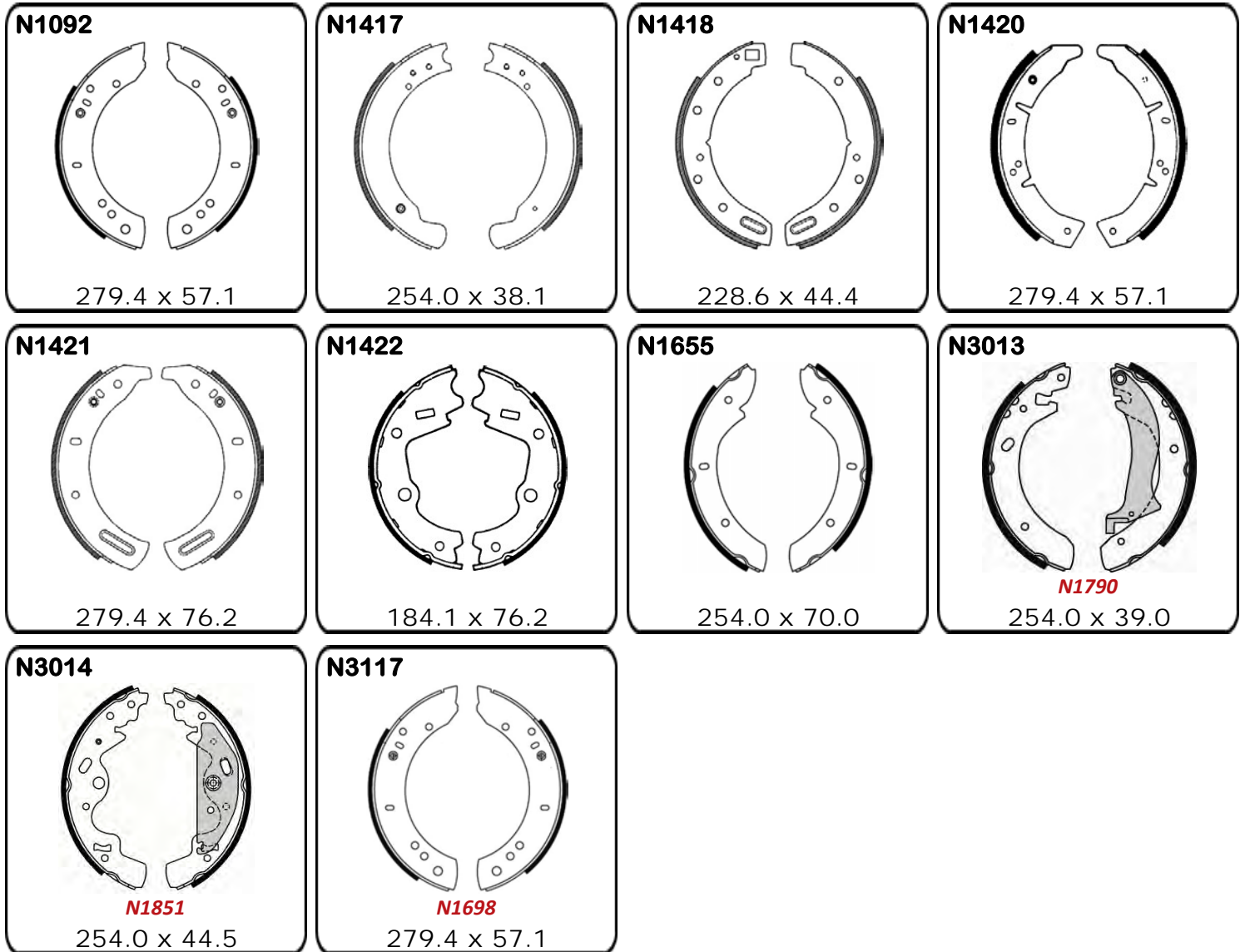

## LEXUS

<b>SC430</b>				
UZZ40	5/2001 on		<b>N3199</b>	190.0 x 25.0



## LEXUS

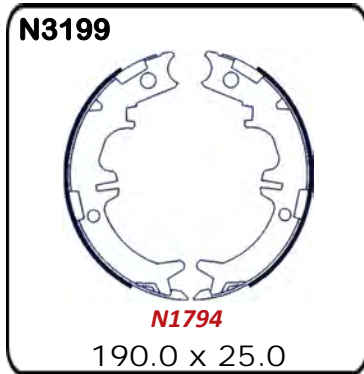

## LEYLAND

### EA Series

EA Series	1970 - 74	<b>N1035</b>	254.0 x 69.8	<b>N1031</b>	254.0 x 69.8
-----------	-----------	--------------	--------------	--------------	--------------

### Marina

All Models	1972 on			<b>N1022</b>	203.2 x 38.1
------------	---------	--	--	--------------	--------------

### Mini/Moke/Van

1098cc, 1100cc	1973 on	<b>N1333</b>	177.8 x 38.1	<b>N1332</b>	177.8 x 31.7
----------------	---------	--------------	--------------	--------------	--------------

### P76

All Models	1973 on			<b>N1164</b>	228.6 x 38.1
------------	---------	--	--	--------------	--------------

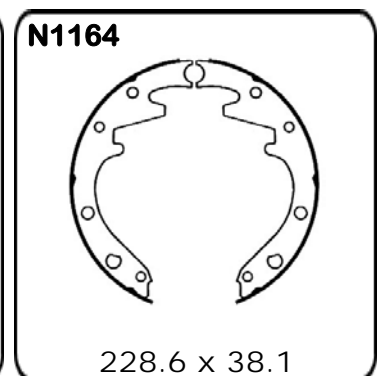
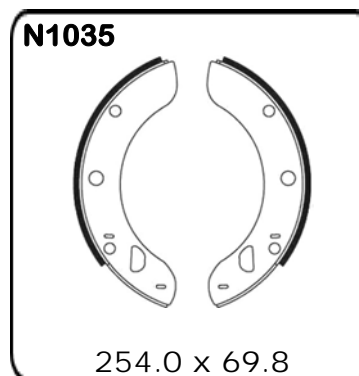
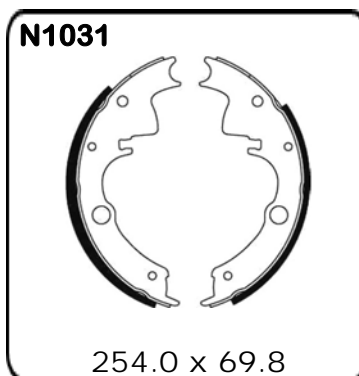
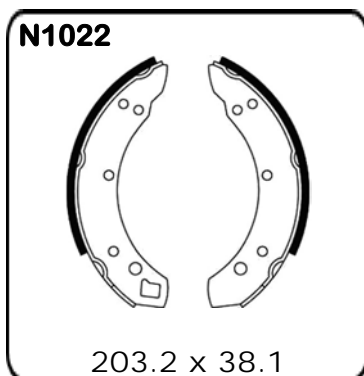





## LEYLAND

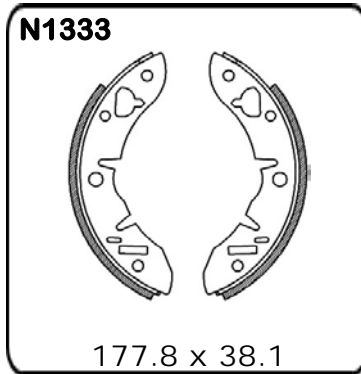
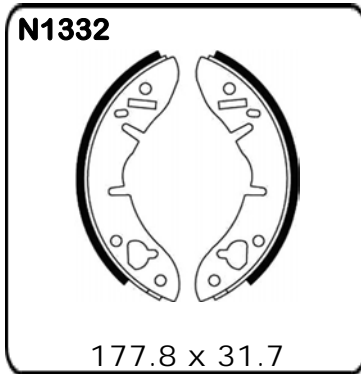

## MAZDA

### 121

DA1 1100cc, 1300cc DB	1987- 11/93			<b>N1664</b>	170.0 x 25.0
DB	11/1993 on			<b>N3115</b>	180.0 x 30.0
DW Metro 1.3L & 1.5L	1996 on			<b>N3113</b>	200.0 x 30.0

### 323

Sedan & Hatch RWD	1977 - 80			<b>N1082</b>	200.0 x 32.0
Wagon RWD	1981 - 85			<b>N1605</b>	200.0 x 32.0
BD Sedan FWD	1981 - 85			<b>N1394</b>	180.0 x 30.0
BF Sedan 1.6L FWD	1985 - 89			<b>N1604</b>	200.0 x 25.0
Wagon FWD	1986 on			<b>N1637</b>	228.6 x 25.0
BF Sedan 1.6L FWD	7/89 on			<b>N1671</b>	200.0 x 25.0
BJ Protégé 1.6L	9/1998 on			<b>N3181</b>	200.0 x 35.0

### 626

Sedan & Coupe RWD	1978 - 79			<b>N1348</b>	228.6 x 42.0
Sedan RWD	1980 - 81			<b>N1408</b>	228.6 x 42.8
GC Sedan & Hatch FWD	1982 on			<b>N1409</b>	200.0 x 25.0

### 800cc

800cc	1963 - 65	<b>N1082</b>	200.0 x 32.0	<b>N1082</b>	200.0 x 32.0
-------	-----------	--------------	--------------	--------------	--------------

### 808

All	1972 - 79			<b>N1342</b>	200.0 x 32.0
-----	-----------	--	--	--------------	--------------

### 929

1.8L	1973 - 79			<b>N1348</b>	228.6 x 42.0
2.0L	1978 - 82			<b>N1408</b>	228.6 x 42.8



## MAZDA

### 1000cc

1000cc	1967 - 68	<b>N1082</b>	200.0 x 32.0	<b>N1082</b>	200.0 x 32.0
--------	-----------	--------------	--------------	--------------	--------------

### 1200cc

With front drums	1970 - 72	<b>N1082</b>	200.0 x 32.0	<b>N1082</b>	200.0 x 32.0
Coupe with front discs	1970 - 72			<b>N1082</b>	200.0 x 32.0

### 1300cc

With front drums	1972 - 76	<b>N1082</b>	200.0 x 32.0	<b>N1082</b>	200.0 x 32.0
With front discs	1972 - 76			<b>N1082</b>	200.0 x 32.0

### 1500cc

1500cc	1966 - 69	<b>N1085</b>	254.0 x 40.0	<b>N1085</b>	254.0 x 40.0
Sports Sedan	1967 - 69			<b>N1085</b>	254.0 x 40.0
1500cc	1969 - 71			<b>N1085</b>	254.0 x 40.0

### 1800cc

1800cc	1969 - 73			<b>N1085</b>	254.0 x 40.0
--------	-----------	--	--	--------------	--------------

### B1500

1000Kg	1966 - 70	<b>N1557</b>	260.0 x 45.0	<b>N1557</b>	260.0 x 45.0
--------	-----------	--------------	--------------	--------------	--------------

### B1600

1000Kg	1971 - 73	<b>N1626</b>	295.0 x 75.0	<b>N1626</b>	295.0 x 75.0
Ute 1000Kg	1972 - 77	<b>N1389</b>	260.0 x 45.0	<b>N1389</b>	260.0 x 45.0

### B1800

Super Ute 500Kg	1977 - 80	<b>N1389</b>	260.0 x 45.0	<b>N1389</b>	260.0 x 45.0
Super Ute 600Kg	1980 - 82			<b>N1411</b>	260.0 x 45.0

### B2000

Super Ute 600 Kg	1982 - 84			<b>N1389</b>	260.0 x 45.0
All Models	1985 on			<b>N1665</b>	260.0 x 50.0

### B2200

All Models	1981 - 84			<b>N1389</b>	260.0 x 45.0
All Models	1985 on			<b>N1665</b>	260.0 x 50.0

### B2500, B2600

UF	2/1988 on			<b>N1665</b>	260.0 x 50.0
2WD & 4WD	4/1996 on			<b>N1665</b>	260.0 x 50.0
UN 2WD	1998 on			<b>N3053</b>	270.0 x 57.0
UN 4WD	2/1999 on			<b>N3179</b>	295.0 x 55.0

### B4000

4.0L	2005 - 06			<b>N3222</b>	295.0 x 55.0
------	-----------	--	--	--------------	--------------

### Bongo Van

F800 Van	1966 - 68	<b>N1082</b>	200.0 x 32.0	<b>N1082</b>	200.0 x 32.0
F1000 Van & Pick-up	1969 - 78	<b>N1082</b>	200.0 x 32.0	<b>N1082</b>	200.0 x 32.0



## MAZDA

### **BT50**

4WD	07 on			<b>N3179</b>	295.0 x 55.0
-----	-------	--	--	--------------	--------------

### **Capella**

1600cc	1970 - 78			<b>N1342</b>	200.0 x 32.0
--------	-----------	--	--	--------------	--------------

### **E1300**

All Models	1978 - 80	<b>N1391</b>	228.6 x 55.0	<b>N1392</b>	180.0 x 45.0
------------	-----------	--------------	--------------	--------------	--------------

### **E1400**

All Models	1980 - 82	<b>N1391</b>	228.6 x 55.0	<b>N1392</b>	180.0 x 45.0
All Models	1982 - 83			<b>N1392</b>	180.0 x 45.0
With Single Rear Wheels	1984 on			<b>N1585</b>	228.6 x 42.0
With Dual Rear Wheels	1984 on			<b>N1586</b>	180.0 x 45.0

### **E1600**

All Models	1978 - 84	<b>N1391</b>	228.6 x 55.0	<b>N1392</b>	180.0 x 45.0
------------	-----------	--------------	--------------	--------------	--------------

### **E1800**

With Single Rear Wheels	1984 on			<b>N1587</b>	260.0 x 50.0
With Dual Rear Wheels	1984 on			<b>N1588</b>	220.0 x 55.0
With SRW	6/1999 on			<b>N3192</b>	270.0 x 50.0
With DRW	6/1999 on			<b>N3193</b>	220.0 x 55.0

### **E2000**

Tray Truck, Most 2000 Kg	1972 - 81	<b>N1520</b>	320.0 x 60.0	<b>N1520</b>	320.0 x 60.0
Tray Truck Some 2000 Kg	1972 - 77	<b>N1522</b>	320.0 x 75.0	<b>N1524</b>	320.0 x 75.0
Van With Single Rear Wheels	1984 on			<b>N1587</b>	260.0 x 50.0
Van With Dual Rear Wheels	1984 on			<b>N1588</b>	220.0 x 55.0
Except SK22 & SK82 Models	6/1999 on			<b>N3194</b>	220.0 x 40.0
With SRW	6/1999 on			<b>N3192</b>	270.0 x 50.0
With DRW	6/1999 - 02			<b>N3193</b>	220.0 x 55.0
With DRW	02 on			<b>N3223</b>	220.0 x 55.0

### **E2200**

All Models	1980 - 82	<b>N1391</b>	228.6 x 55.0	<b>N1392</b>	180.0 x 45.0
All Models	1982 - 84			<b>N1392</b>	180.0 x 45.0
With Single Rear Wheels	1984 on			<b>N1587</b>	260.0 x 50.0
With Dual Rear Wheels	1984 on			<b>N1588</b>	220.0 x 55.0
With SRW	6/1999 on			<b>N3192</b>	270.0 x 50.0
With DRW	6/1999 - 3/01			<b>N3193</b>	220.0 x 55.0
Van	3/2001 - 07			<b>N3061</b>	270.0 x 50.0

### **E2500**

Tray Truck 3000 Kg	1972 - 73	<b>N1520</b>	320.0 x 60.0	<b>N1520</b>	320.0 x 60.0
With DRW	02 on			<b>N3223</b>	220.0 x 55.0
With Dual Rear Wheels Chass 100109 on	2002 on			<b>N3223</b>	220.0 x 55.0



## MAZDA

<b>E2700</b>					
Tray Truck 3000 Kg	1973 - 77	N1520	320.0 x 60.0	N1524	320.0 x 75.0
<b>E3000</b>					
Tray Truck 3000 Kg	1977 - 81	N1522	320.0 x 75.0	N1524	320.0 x 75.0
<b>Mazda 2</b>					
1.5L	1/03 - 6/07			N3074	203.2 x 38.0
<b>MPV</b>					
LW, LWA2	1999 - 03			N3055	254.0 x 50.0
<b>MX Series</b>					
MX6	7/1987 - 6/91			N3147	228.6 x 30.0
<b>RX Series</b>					
R100	1969 - 71			N1082	200.0 x 32.0
RX2, RX3	1970 - 76			N1342	200.0 x 32.0
RX4, RX7	1973 - 80			N1348	228.6 x 42.0
<b>T2000</b>					
Tray SRW 2000Kg	1981 on	N1521	320.0 x 75.0	N1643	228.6 x 75.0
Tray DRW 2000Kg Some	1981 - 82	N1521	320.0 x 75.0	N1521	320.0 x 75.0
Tray DRW 2000Kg Some	1981 - 82	N1521	320.0 x 75.0	N1523	320.0 x 75.0
Tray DRW	1983 on	N1521	320.0 x 75.0	N1523	320.0 x 75.0
Handbrake	To 1988		Handbrake	N1546	180.0 x 35.0
Handbrake	1988 on		Handbrake	N3138	190.0 x 35.0
<b>T3000</b>					
Tray 2000Kg	1981 - 84	N1521	320.0 x 75.0	N1521	320.0 x 75.0
Tray 2000Kg Some	1981 - 84	N1521	320.0 x 75.0	N1523	320.0 x 75.0
Tray	1984 - 88	N1521	320.0 x 75.0	N1523	320.0 x 75.0
Handbrake	To 1988		Handbrake	N1546	180.0 x 35.0
<b>T3500</b>					
Tray Crew-cab 2000/3000Kg Some	1984 on	N1523	320.0 x 75.0	N1523	320.0 x 75.0
Tray Crew-cab 2000/3000Kg Some	1984 on	N1521	320.0 x 75.0	N1521	320.0 x 75.0
Tray Crew-cab 2000/3000Kg Some	1984 on	N1521	320.0 x 75.0	N1523	320.0 x 75.0
Handbrake	To 1988		Handbrake	N1546	180.0 x 35.0
Handbrake	1988 on		Handbrake	N3138	190.0 x 35.0
Tray, Crew-Cab 2000Kg	1992 on	N1521	320.0 x 75.0	N1523	320.0 x 75.0
Tray, Crew-Cab 3500Kg	1992 on	N3108	320.0 x 90.0	N3109	320.0 x 90.0
Tray, Crew-Cab 4000Kg	1992 on	N3126	320.0 x 110.0	N3127	320.0 x 110.0
<b>T4100</b>					
Tray, Crew-Cab 3500Kg	1981 - 84	N1590	320.0 x 90.0	N1589	320.0 x 90.0
Tray, Crew-Cab 4000Kg	1984 on	N3126	320.0 x 110.0	N3127	320.0 x 110.0
Handbrake	To 1988		Handbrake	N1546	180.0 x 35.0



## MAZDA

<b>T4100</b>					
Handbrake	1988 on		<b>Handbrake</b>	<b>N3138</b>	190.0 x 35.0
Tray, Crew-Cab 3500Kg Handbrake			<b>Handbrake</b>	<b>N1547</b>	203.2 x 45.0

<b>T4600</b>					
T4600	1992 - 95	<b>N3126</b>	320.0 x 110.0	<b>N3127</b>	320.0 x 110.0
T4600	2000 on	<b>N3011</b>	320.0 x 90.0	<b>N3011</b>	320.0 x 90.0

<b>Tribute</b>					
Wagon 3.0L	1/2001 on			<b>N3000</b>	228.6 x 41.5
3.0L	05 on		<b>Handbrake</b>	<b>N3076</b>	186.0 x 30.0

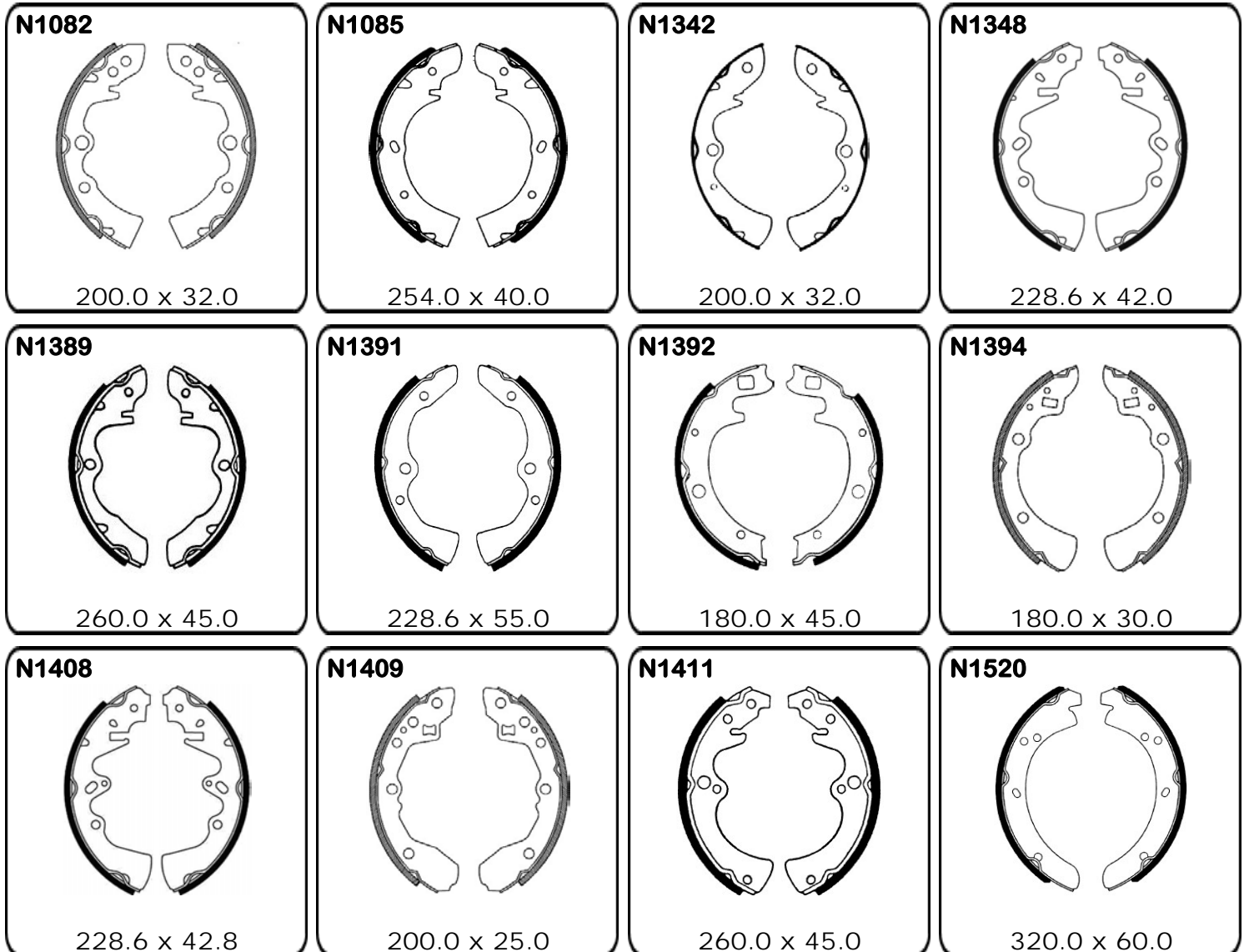





## MAZDA

**N1521**

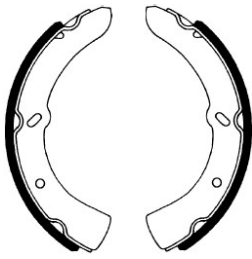

320.0 x 75.0

**N1522**

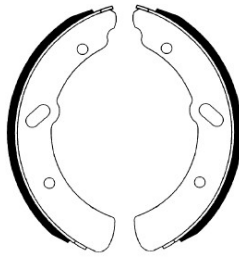

320.0 x 75.0

**N1523**

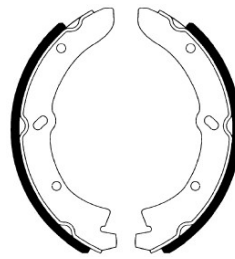

320.0 x 75.0

**N1524**

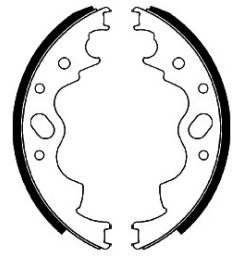

320.0 x 75.0

**N1546**

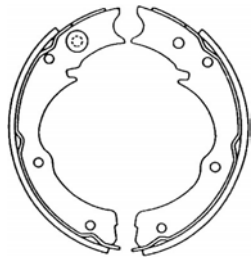

180.0 x 35.0

**N1547**

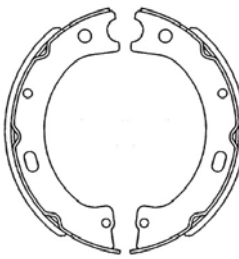

203.2 x 45.0

**N1557**

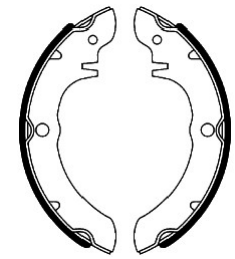

260.0 x 45.0

**N1585**

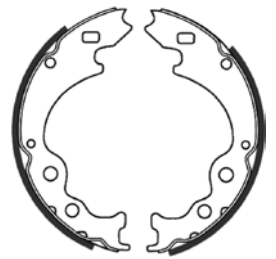

228.6 x 42.0

**N1586**

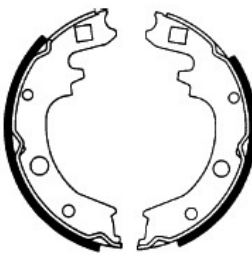

180.0 x 45.0

**N1587**

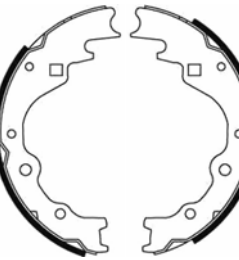

260.0 x 50.0

**N1588**

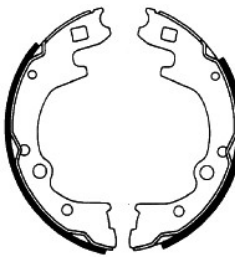

220.0 x 55.0

**N1589**

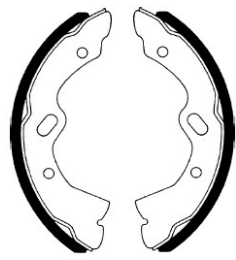

320.0 x 90.0

**N1590**

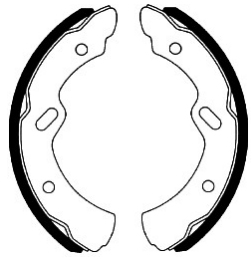

320.0 x 90.0

**N1604**

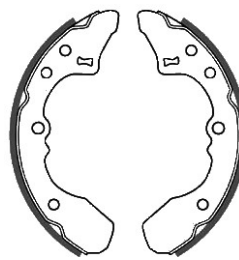

200.0 x 25.0

**N1605**

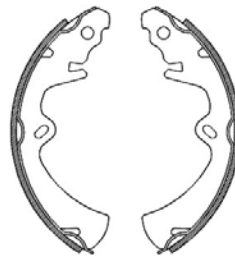

200.0 x 32.0

**N1626**

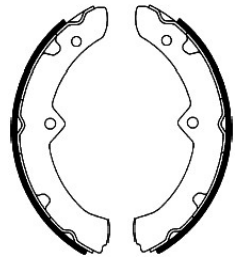

295.0 x 75.0



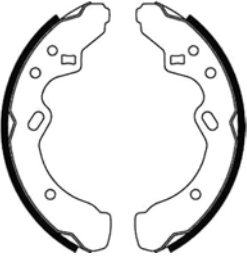
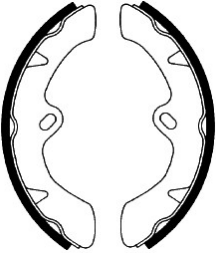
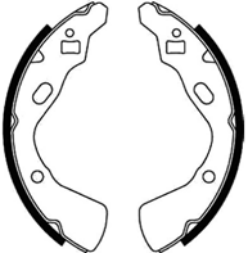
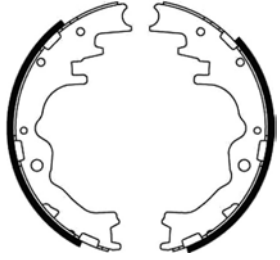
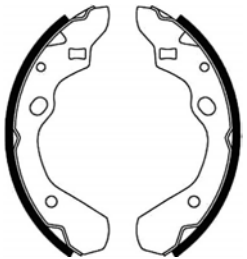
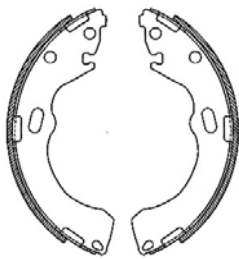
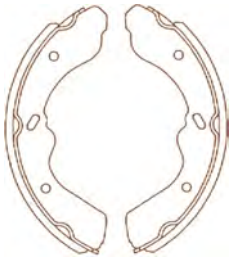
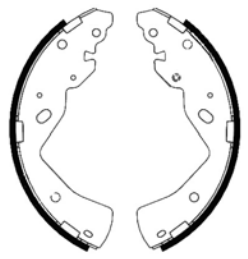
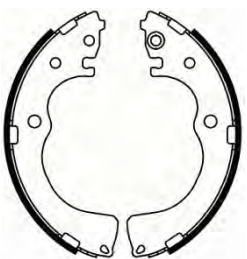
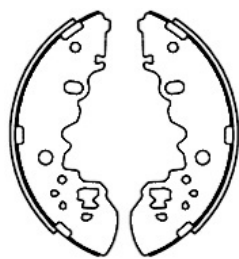
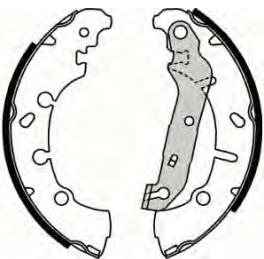
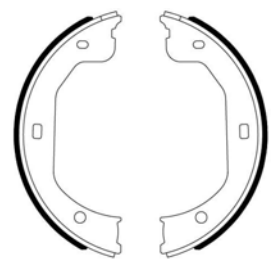
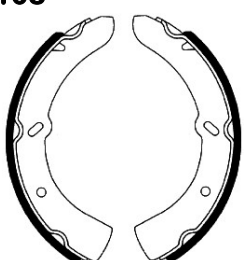
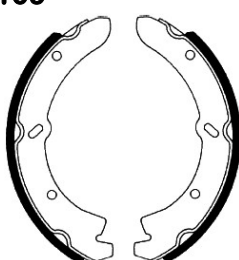
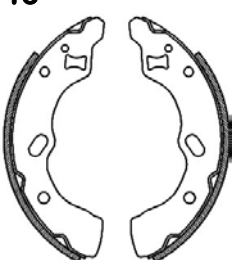
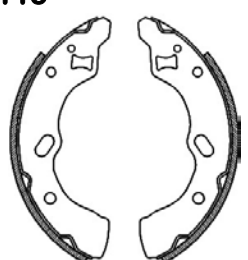

## MAZDA

<p><b>N1637</b></p>  <p>228.6 x 25.0</p>	<p><b>N1643</b></p>  <p>228.6 x 75.0</p>	<p><b>N1664</b></p>  <p>170.0 x 25.0</p>	<p><b>N1665</b></p>  <p>260.0 x 50.0</p>
<p><b>N1671</b></p>  <p>200.0 x 25.0</p>	<p><b>N3000</b></p>  <p><b>N1791</b> 228.6 x 41.5</p>	<p><b>N3011</b></p>  <p><b>N1856</b> 320.0 x 90.0</p>	<p><b>N3053</b></p>  <p><b>N1822</b> 270.0 x 57.0</p>
<p><b>N3055</b></p>  <p><b>N1845</b> 254.0 x 50.0</p>	<p><b>N3061</b></p>  <p><b>N1863</b> 270.0 x 50.0</p>	<p><b>N3074</b></p>  <p><b>N1830</b> 203.2 x 38.0</p>	<p><b>N3076</b></p>  <p><b>N1883/BS5017</b> 186.0 x 30.0</p>
<p><b>N3108</b></p>  <p><b>N1689</b> 320.0 x 90.0</p>	<p><b>N3109</b></p>  <p><b>N1690</b> 320.0 x 90.0</p>	<p><b>N3113</b></p>  <p><b>N1694</b> 200.0 x 30.0</p>	<p><b>N3115</b></p>  <p><b>N1696</b> 180.0 x 30.0</p>

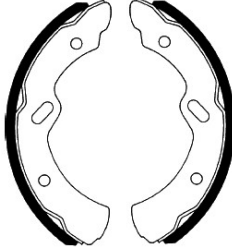
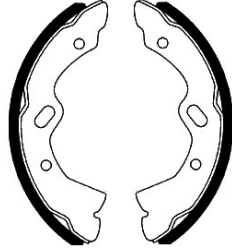
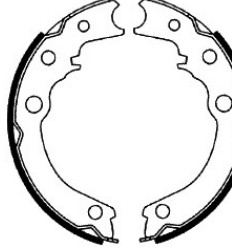
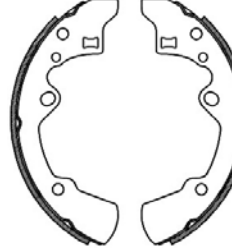
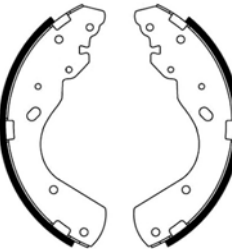
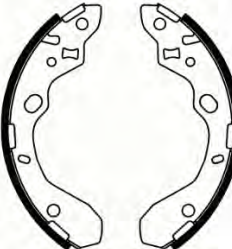
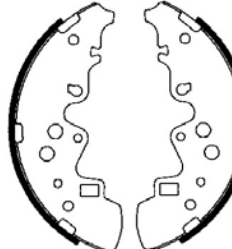
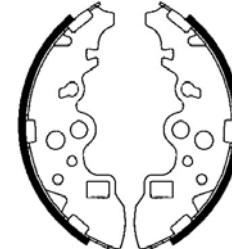
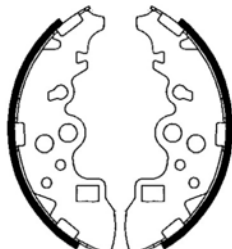

## MAZDA

<p><b>N3126</b></p>  <p><b>N1708</b></p> <p>320.0 x 110.0</p>	<p><b>N3127</b></p>  <p><b>N1709</b></p> <p>320.0 x 110.0</p>	<p><b>N3138</b></p>  <p><b>N1720</b></p> <p>190.0 x 35.0</p>	<p><b>N3147</b></p>  <p><b>N1734</b></p> <p>228.6 x 30.0</p>
<p><b>N3179</b></p>  <p><b>N1769</b></p> <p>295.0 x 55.0</p>	<p><b>N3181</b></p>  <p><b>N1771</b></p> <p>200.0 x 35.0</p>	<p><b>N3192</b></p>  <p><b>N1784</b></p> <p>270.0 x 50.0</p>	<p><b>N3193</b></p>  <p><b>N1785</b></p> <p>220.0 x 55.0</p>
<p><b>N3194</b></p>  <p><b>N1786</b></p> <p>220.0 x 40.0</p>	<p><b>N3222</b></p>  <p><b>No Profile Available</b></p> <p><b>N1892</b></p> <p>295.0 x 55.0</p>	<p><b>N3223</b></p>  <p><b>N1864</b></p> <p>220.0 x 55.0</p>	

## MERCEDES BENZ

### 1 Series

180 Sedan, 190B, 190C, 190DC	1953 - 63	<b>N1212</b>	230.0 x 50.0	<b>N1213</b>	230.0 x 50.0
190SL Coupe	1958 - 63	<b>N1214</b>	230.0 x 65.0	<b>N1215</b>	230.0 x 65.0



## MERCEDES BENZ

### 1 Series

190C, 190DC	1964 - 66			<b>N1211</b>	230.0 x 65.0
190 Handbrake	1993 on		<b>Handbrake</b>	<b>N3023</b>	164.0 x 20.0

### 2 Series

200 Series With Girling or ATE Front Brakes	1963 - 68			<b>N1211</b>	230.0 x 65.0
Handbrake	1965 - 84		<b>Handbrake</b>	<b>N1630</b>	160.0 x 25.0
Handbrake	1985 on		<b>Handbrake</b>	<b>N3023</b>	164.0 x 20.0

### 3 Series

300, 300B, 300D, 300SL	1958 - 60	<b>N1207</b>	260.0 x 90.0	<b>N1208</b>	260.0 x 90.0
Handbrake	1965 - 84		<b>Handbrake</b>	<b>N1630</b>	160.0 x 25.0
Handbrake	1985 on		<b>Handbrake</b>	<b>N3023</b>	164.0 x 20.0
Handbrake S Series	1991 on		<b>Handbrake</b>	<b>N3024</b>	164.0 x 25.0

### 4/5/6 Series

Handbrake	1965 on		<b>Handbrake</b>	<b>N1630</b>	160.0 x 25.0
Handbrake	1991 on		<b>Handbrake</b>	<b>N3024</b>	164.0 x 25.0

### A140

W168	7/97 - 8/04			<b>N3059</b>	180.0 x 42.0
------	-------------	--	--	--------------	--------------

### A150

W169 Handbrake	9/2004 on		<b>Handbrake</b>	<b>N3023</b>	164.0 x 20.0
----------------	-----------	--	------------------	--------------	--------------

### A160

W168	7/97 - 8/04			<b>N3059</b>	180.0 x 42.0
W169 Handbrake	9/2004 on		<b>Handbrake</b>	<b>N3023</b>	164.0 x 20.0

### A170

W168	7/97 - 8/04			<b>N3059</b>	180.0 x 42.0
W169 Handbrake	9/2004 on		<b>Handbrake</b>	<b>N3023</b>	164.0 x 20.0

### A190

W168	7/97 - 8/04			<b>N3059</b>	180.0 x 42.0
W168 Handbrake	1999 - 04		<b>Handbrake</b>	<b>N3023</b>	164.0 x 20.0

### A200

W169 Handbrake	9/2004 on		<b>Handbrake</b>	<b>N3023</b>	164.0 x 20.0
----------------	-----------	--	------------------	--------------	--------------

### A210

W168 Handbrake	1999 - 04		<b>Handbrake</b>	<b>N3023</b>	164.0 x 20.0
----------------	-----------	--	------------------	--------------	--------------

### B180

W245	3/05 on		<b>Handbrake</b>	<b>N3023</b>	164.0 x 20.0
------	---------	--	------------------	--------------	--------------

### B200

W245	3/05 on		<b>Handbrake</b>	<b>N3023</b>	164.0 x 20.0
------	---------	--	------------------	--------------	--------------

### C Class

Handbrake	1993 on		<b>Handbrake</b>	<b>N3023</b>	164.0 x 20.0
-----------	---------	--	------------------	--------------	--------------





## MERCEDES BENZ

### E320

W210 Handbrake	5/1999 on		Handbrake	N3023	164.0 x 20.0
----------------	-----------	--	-----------	-------	--------------

### MB100

2.4D	1987 on			N3025	254.0 x 57.0
------	---------	--	--	-------	--------------

### MB140

2.4D	1987 on			N3025	254.0 x 57.0
------	---------	--	--	-------	--------------

### ML430

W163	1999 on		Handbrake	N3054	184.0 x 30.0
------	---------	--	-----------	-------	--------------

### ML500

W163	2000 on		Handbrake	N3054	184.0 x 30.0
------	---------	--	-----------	-------	--------------

### ML55AMG

W163	2001 on		Handbrake	N3054	184.0 x 30.0
------	---------	--	-----------	-------	--------------

### Sprinter

Handbrake 2T All Models	1995 on		Handbrake	N3026	160.0 x 40.0
-------------------------	---------	--	-----------	-------	--------------

Handbrake 3T, 308D, 310D, 312TD, 314, 408D	1995 on		Handbrake	N3027	170.0 x 40.0
--	---------	--	-----------	-------	--------------

Handbrake 4T All Models	4/2000 on		Handbrake	N3027	170.0 x 40.0
-------------------------	-----------	--	-----------	-------	--------------

Handbrake 3T, 308DCDI, 311CDI, 313CDI, 316CDI	4/2000 on		Handbrake	N3026	160.0 x 40.0
---	-----------	--	-----------	-------	--------------

### Vito

Handbrake 638 All Models	1999 - 03		Handbrake	N3028	177.8 x 20.0
--------------------------	-----------	--	-----------	-------	--------------

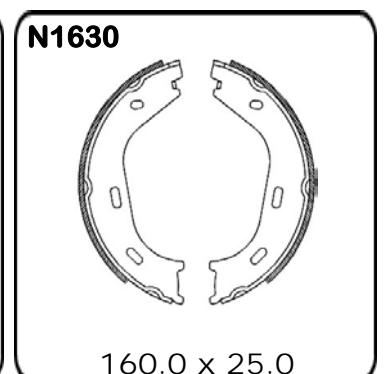
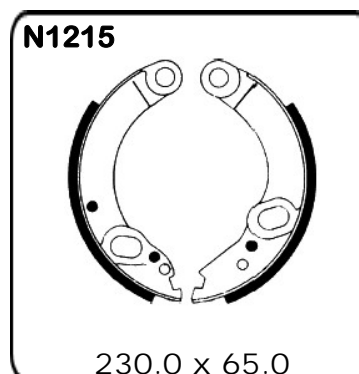
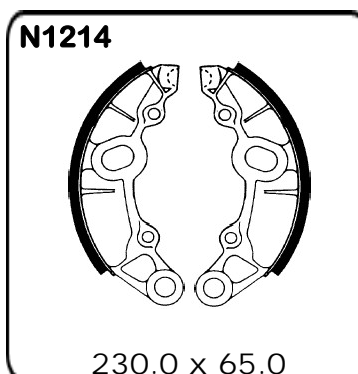
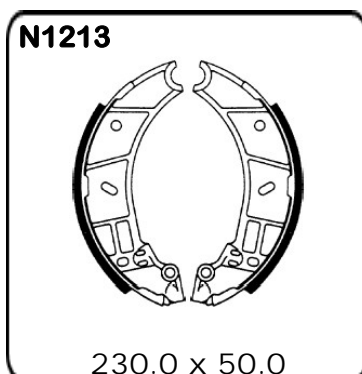
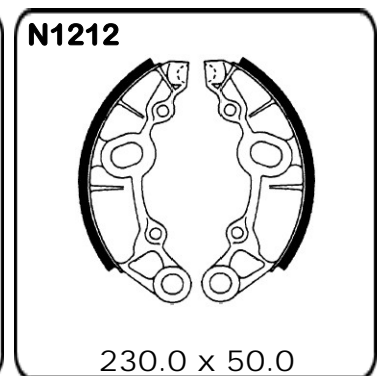
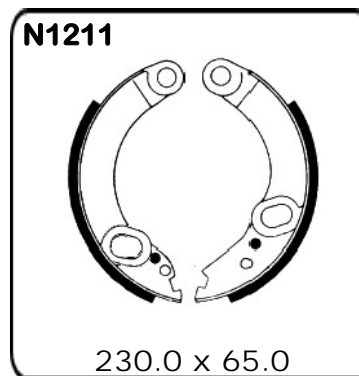
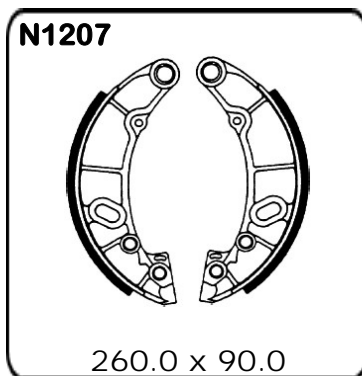





## MERCEDES BENZ

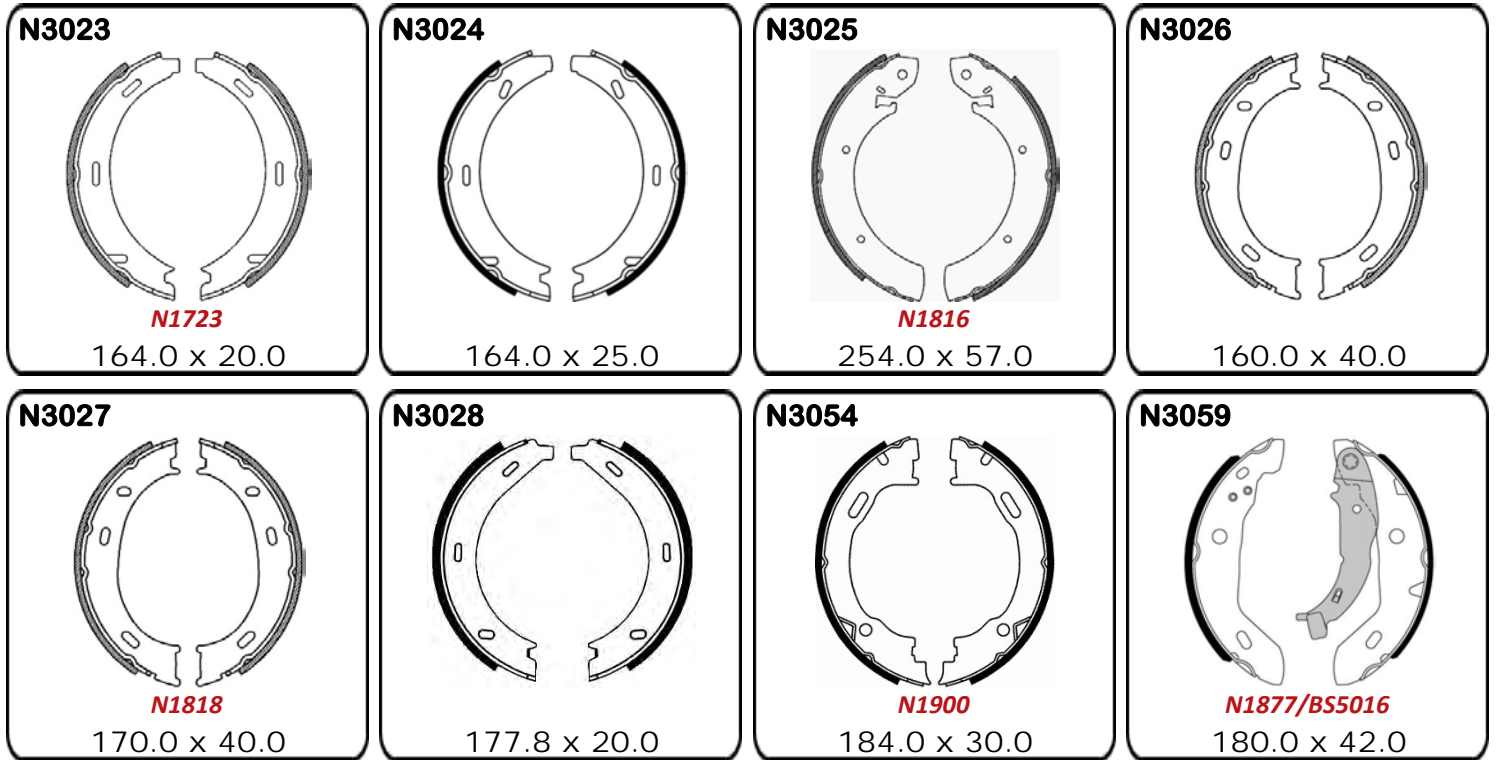

## MG

### Magnette

Magnette	1954 - 59	<b>N1325</b>	254.0 x 44.4	<b>N1325</b>	254.0 x 44.4
Magnette	1959 - 62	<b>N1145</b>	228.6 x 63.5	<b>N1002</b>	228.6 x 44.4

### MGA

1500	1956 - 59	<b>N1325</b>	254.0 x 44.4	<b>N1325</b>	254.0 x 44.4
1600	1960 - 62			<b>N1325</b>	254.0 x 44.4

### MGB

Sports & GT Coupe	1963 - 73			<b>N1425</b>	254.0 x 44.4
-------------------	-----------	--	--	--------------	--------------

### Midget

Midget	1968 - 72			<b>N1227</b>	177.8 x 31.7
--------	-----------	--	--	--------------	--------------



## MG

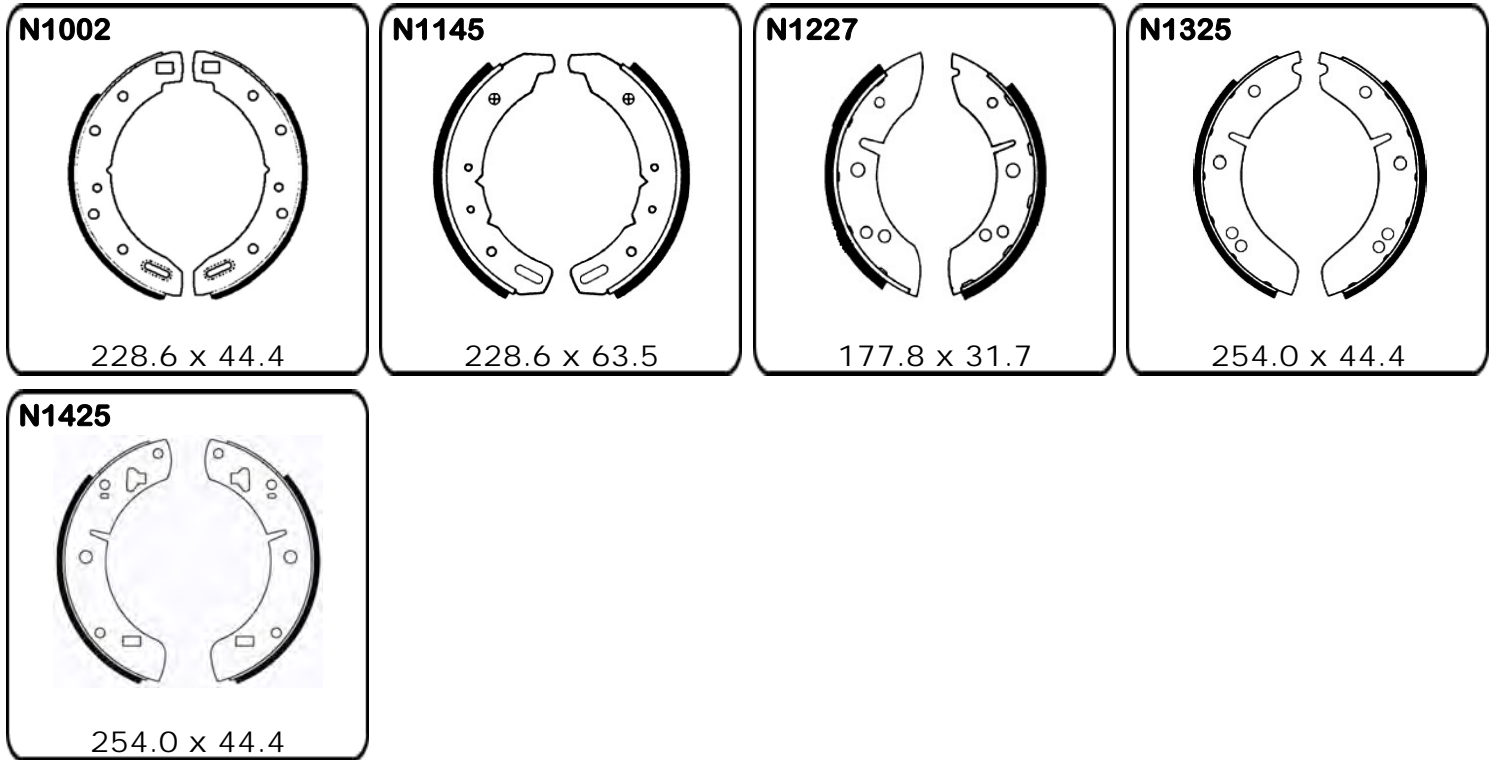

## MITSUBISHI

### 1000

A20 Sedan Series I	1964 - 67	<b>N1073</b>	229.0 x 35.0	<b>N1073</b>	229.0 x 35.0
Sedan Series II	1967 - 68	<b>N1185</b>	203.2 x 35.0	<b>N1186</b>	203.2 x 35.0

### 1100

A21 Sedan	1967 - 71	<b>N1073</b>	229.0 x 35.0	<b>N1073</b>	229.0 x 35.0
-----------	-----------	--------------	--------------	--------------	--------------

### Canter

T93, T97 2.3 Tonne	1971 - 73	<b>N1560</b>	300.0 x 70.0	<b>N1561</b>	300.0 x 60.0
T210, T217 Cab-Chassis	1973 - 78	<b>N1560</b>	300.0 x 70.0	<b>N1561</b>	300.0 x 60.0
FC211, FE211	1979 - 80	<b>N1560</b>	300.0 x 70.0	<b>N1561</b>	300.0 x 60.0
FK102 Handbrake	1980 - 83		<b>Handbrake</b>	<b>N3010</b>	203.2 x 51.0
FC211, FE211C, FE211, FE214E, FE211ELG	1981 - 84	<b>N1562</b>	320.0 x 75.0	<b>N1562</b>	320.0 x 75.0
FK115 Handbrake	1983 - 84		<b>Handbrake</b>	<b>N3010</b>	203.2 x 51.0
FK415, FK417 Handbrake	1985 - 95		<b>Handbrake</b>	<b>N3010</b>	203.2 x 51.0



## MITSUBISHI

### Canter

FB300, FE300, FE320 - Imports	1985 - 89			<b>N3009</b>	228.6 x 62.0
FE432C, 432E, 434C, 444, 444C 444E, 444EW	1986 on	<b>N1562</b>	320.0 x 75.0	<b>N1562</b>	320.0 x 75.0
FE432C, 432E, 434C, 444, 444C 444E, 444EW	1986 on		<b>Handbrake</b>	<b>N1563</b>	180.0 x 35.0
FE333, FE334	1991 on		<b>Handbrake</b>	<b>N1563</b>	180.0 x 35.0
FE439, FE449, FE649	1991 on	<b>N1562</b>	320.0 x 75.0	<b>N1562</b>	320.0 x 75.0
FE333, FE334	1991 on	<b>N1562</b>	320.0 x 75.0	<b>N1562</b>	320.0 x 75.0
FE439, FE449, FE649	1991 on		<b>Handbrake</b>	<b>N3137</b>	180.0 x 35.0
FB511	1994 - 96			<b>N3009</b>	228.6 x 62.0
FE659 3900	1996 - 99	<b>N3090</b>	320.0 x 110.0	<b>N3090</b>	320.0 x 110.0
FE658 4600	1996 - 99	<b>N3090</b>	320.0 x 110.0	<b>N3090</b>	320.0 x 110.0
FF63D, FF63E 1900	1996 - 02	<b>N3090</b>	320.0 x 110.0		
FE53C 4200	1999 - 02	<b>N3090</b>	320.0 x 110.0	<b>N3090</b>	320.0 x 110.0
FE83D 4900 3.5T, FE73E, FE83E 5200 4T	2002 on	<b>N3090</b>	320.0 x 110.0	<b>N3090</b>	320.0 x 110.0

### Challenger

Handbrake	3/1998 on		<b>Handbrake</b>	<b>N3030</b>	200.0 x 38.0
-----------	-----------	--	------------------	--------------	--------------

### Colt

A51 Sedan 1.3L Drum/Drum	1970 - 71	<b>N1343</b>	228.6 x 35.0	<b>N1351</b>	203.2 x 35.0
A51 Sedan 1.3L Disc/Drum	1970 - 71			<b>N1351</b>	203.2 x 35.0
RA 1.4L To Chassis CH8006831	1980 - 82			<b>N1395</b>	180.0 x 35.0
RA 1.4L From Chas CH8006832	1982 on			<b>N1398</b>	180.0 x 35.0
RB - RE 1.4L & 1.6L	1982 on			<b>N1398</b>	180.0 x 35.0
RZ	2006 on			<b>N3073</b>	203.2 x 30.0
RG	2004 on			<b>N3068</b>	203.2 x 31.5

### Cordia

AA Hatch 1.6L	1983 - 84			<b>N1476</b>	203.2 x 35.0
AB Hatch 1.8L	1984			<b>N1476</b>	203.2 x 35.0
AB, AC Hatch 1.8L	1984			<b>N1592</b>	203.2 x 35.0
GSR Turbo	1985 on			<b>N1636</b>	203.2 x 35.0

### D50

All Models	1978 - 80			<b>N1444</b>	241.3 x 50.0
------------	-----------	--	--	--------------	--------------

### Delica

2.5L	1989 - 95			<b>N1653</b>	254.0 x 50.0
------	-----------	--	--	--------------	--------------

### Fuso

FN Series	6/83 - 4/99		<b>Handbrake</b>	<b>N3080</b>	304.8 x 75.0
FP Series	6/83 - 5/99		<b>Handbrake</b>	<b>N3080</b>	304.8 x 75.0
FR, FS, FT, FU Series	11/86 on		<b>Handbrake</b>	<b>N3080</b>	304.8 x 75.0
FV, FW Series	6/86 on		<b>Handbrake</b>	<b>N3080</b>	304.8 x 75.0
K, KA, KS, KV Series	8/86 on		<b>Handbrake</b>	<b>N3080</b>	304.8 x 75.0
MP, MS, MU Series	7/88 on		<b>Handbrake</b>	<b>N3080</b>	304.8 x 75.0



## MITSUBISHI

### Galant

GA, GB 1300 & 1500 Drum/Drum	1971 - 74	<b>N1343</b>	228.6 x 35.0	<b>N1351</b>	203.2 x 35.0
GA, GB 1300 & 1500 Disc /Drum	1971 - 74			<b>N1351</b>	203.2 x 35.0
GB Wagon 1600	1973 - 74	<b>N1343</b>	228.6 x 35.0	<b>N1382</b>	203.2 x 34.0
GC	1974 - 76	<b>N1343-1</b>	228.6 x 45.0	<b>N1351</b>	203.2 x 35.0

### L200

MA 1.6L 2WD & 2.0L 4WD	1980 - 81			<b>N1403</b>	241.3 x 50.0
MA 2.0L 2WD	1980 - 81			<b>N1444</b>	241.3 x 50.0
MB, MC, MD Petrol	1981 - 87			<b>N1403</b>	241.3 x 50.0
MD, MD 2.4L Diesel	1982 - 87			<b>N1594</b>	254.0 x 50.8

### L300 & Starwagon

SA	1980 - 81			<b>N1401</b>	220.0 x 45.0
SB	1982 - 83			<b>N1593</b>	254.0 x 50.8
SC, SD, SE	1983 - 87			<b>N1594</b>	254.0 x 50.8
SF, SG, SH, SJ 4WD	1986 on			<b>N1653</b>	254.0 x 50.0
SF, SG, SH 2WD	1986 - 94			<b>N1594</b>	254.0 x 50.8
EFI Models	1988 on			<b>N1594</b>	254.0 x 50.8
WA Starwagon 2.0L	6/1994 on			<b>N3170</b>	254.0 x 50.8
WA Starwagon 2.4L & V6	6/1994 on			<b>N3169</b>	270.0 x 52.0

### Lancer

LA, LB, LC With 8" Rear Brakes Most	1975 - 81			<b>N1351</b>	203.2 x 35.0
LA, LB, LC With 9" Rear Brakes Some	1975 - 81			<b>N1382</b>	203.2 x 34.0
CA, CB	1988 - 4/90			<b>N1677</b>	180.0 x 35.0
CA, CB	5/1990 on			<b>N3100</b>	180.0 x 35.0
CC 1.5L GL	1992 - 5/95			<b>N3118</b>	203.2 x 35.0
CE 1.5L	4/1996 on			<b>N3100</b>	180.0 x 35.0
CE, CG, CH ES	2000 on			<b>N3073</b>	203.2 x 30.0
CE Wagon 1.8L	2000 on			<b>N3118</b>	203.2 x 35.0
CH VR-X	07 on		<b>Handbrake</b>	<b>N3180</b>	167.0 x 32.0

### Magna

TE, TF V6 With ABS Alternate Handbrake	1995 on		<b>Handbrake</b>	<b>N3180</b>	167.0 x 32.0
TE, TF V6 With ABS Banksia Park Brake	4/1996 - 7/96	<b>Major</b>	PBK125	<b>Minor</b>	PBK124
TF Wagon V6 With ABS Banksia Park Brake	6/1997 - 3/99	<b>Major</b>	PBK125	<b>Minor</b>	PBK124
TH, TJ Sedan & Wagon Banksia Park Brake	3/1999 - 8/01	<b>Major</b>	PBK125	<b>Minor</b>	PBK124

### Mirage

CE	5/1996 on			<b>N3100</b>	180.0 x 35.0
----	-----------	--	--	--------------	--------------

### Nimbus

UA, UB, UC	1984 - 92			<b>N1592</b>	203.2 x 35.0
UF	2/1992 on			<b>N3131</b>	228.6 x 40.0



## MITSUBISHI

### Outlander

Outlander	2003 on			<b>N3029</b>	228.6 x 30.0
Outlander	2006 on		Handbrake	<b>N3180</b>	167.0 x 32.0

### Pajero

NA - NG	1983 - 91			<b>N1594</b>	254.0 x 50.8
NJ - NL Handbrake	1991 on		Handbrake	<b>N3030</b>	200.0 x 38.0
NM 3.5L - NP	1999 on		Handbrake	<b>N3086</b>	200.0 x 34.0
IO 1.8L	1999 on			<b>N3029</b>	228.6 x 30.0

### Rosa

BE632, BE632E	1997 on	<b>N3090</b>	320.0 x 110.0	<b>N3090</b>	320.0 x 110.0
BE639 Bus	2000 on		Handbrake	<b>N3136</b>	190.0 x 45.0
BE649	2000 - 08			<b>N3090</b>	320.0 x 110.0
BE64D	08 on			<b>N3090</b>	320.0 x 110.0

### Sigma

GE, With Imported Brakes	1977 - 78			<b>N1382</b>	203.2 x 34.0
GE, With Girlock Rear Brakes	1978 - 80			<b>N1384</b>	228.6 x 44.4
GH, GJ, GK Check against Profile	1980 - 85			<b>N1384-2</b>	228.6 x 44.4
GH, GJ, GK Check against Profile	1980 - 85			<b>N1384-3</b>	228.6 x 44.4
GH, GJ, GK, GN Check against Profile	1980 - 87			<b>N1384-1</b>	228.6 x 44.4
GH, GJ, GK Check against Profile	1980 - 85			<b>N1384</b>	228.6 x 44.4
GH, GJ, GK Handbrake	1980 - 87		Handbrake	<b>N1443</b>	177.0 x 26.0

### Triton

All Models	1987 - 96			<b>N1594</b>	254.0 x 50.8
K65T, K67T	6/96 - 07			<b>N3170</b>	254.0 x 50.8
K76T, K77T	6/96 - 07			<b>N3169</b>	270.0 x 52.0
ML & MN	2007 on			<b>N3093</b>	295.0 x 50.0

### Verada

KE - KJ Banksia Park Brake	10/1996 - 8/01	Major	PBK125	Minor	PBK124
----------------------------	----------------	-------	--------	-------	--------

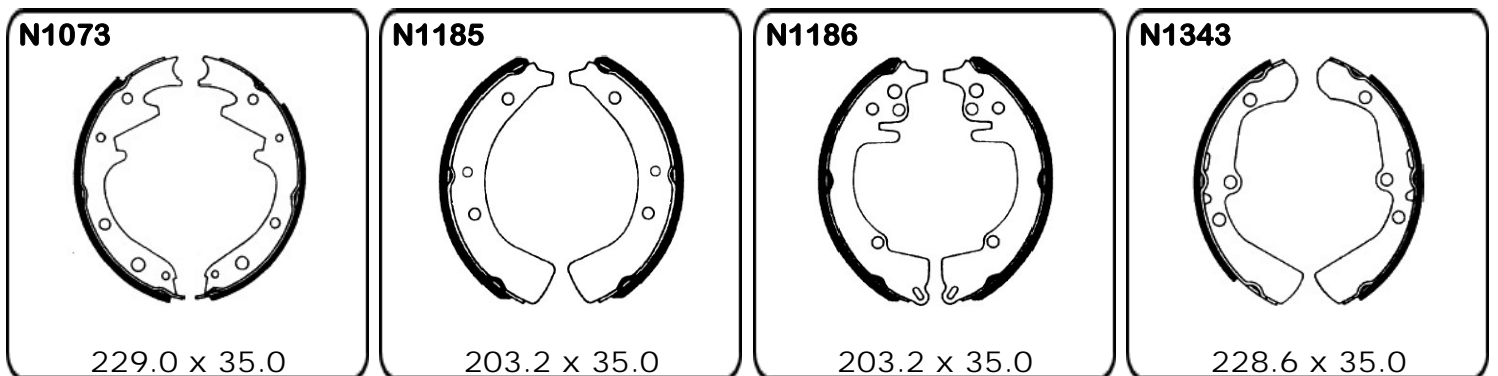





## MITSUBISHI

**N1343-1**

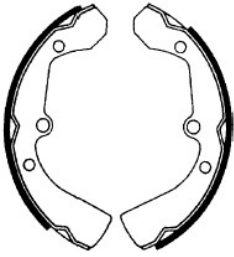

228.6 x 45.0

**N1351**

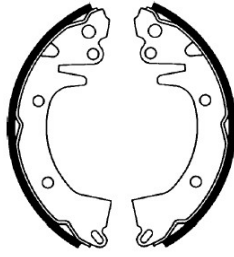

203.2 x 35.0

**N1382**

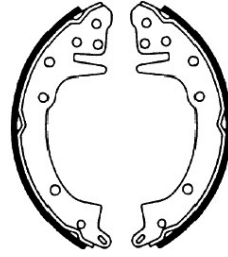

203.2 x 34.0

**N1384**

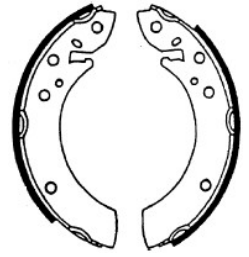

228.6 x 44.4

**N1384-1**

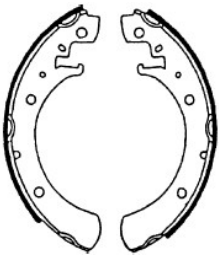

228.6 x 44.4

**N1384-2**

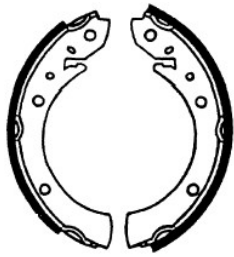

228.6 x 44.4

**N1384-3**

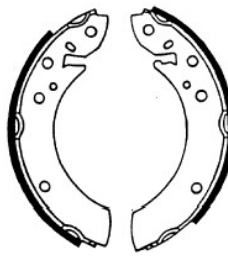

228.6 x 44.4

**N1395**

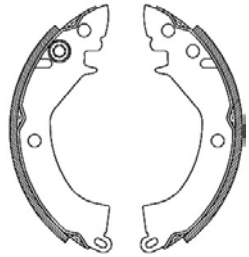

180.0 x 35.0

**N1398**

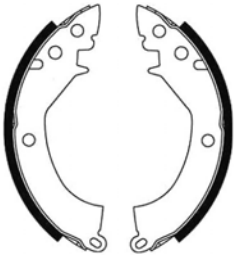

180.0 x 35.0

**N1401**

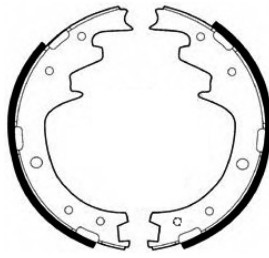

220.0 x 45.0

**N1403**

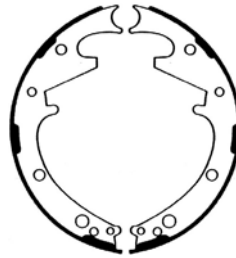

241.3 x 50.0

**N1443**

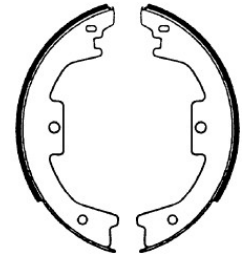

177.0 x 26.0

**N1444**

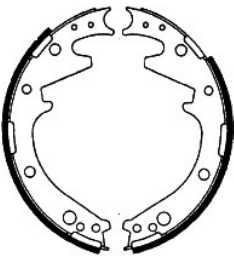

241.3 x 50.0

**N1476**

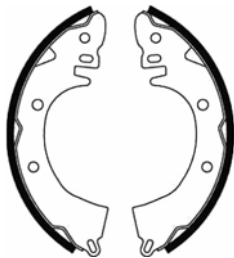

203.2 x 35.0

**N1560**

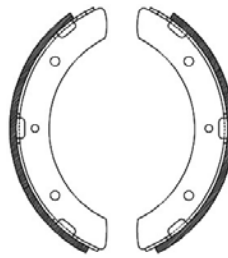

300.0 x 70.0

**N1561**

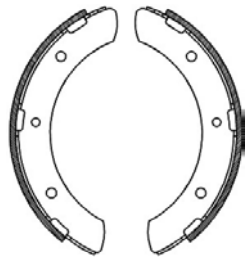

300.0 x 60.0



## MITSUBISHI

**N1562**

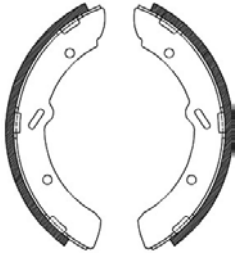

320.0 x 75.0

**N1563**

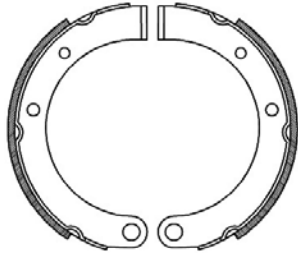

180.0 x 35.0

**N1592**

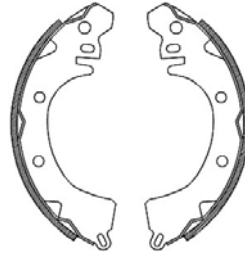

203.2 x 35.0

**N1593**

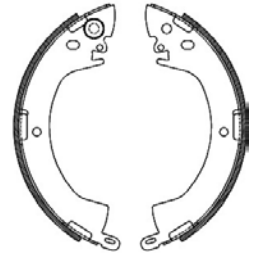

254.0 x 50.8

**N1594**

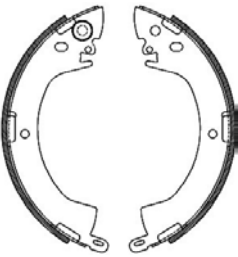

254.0 x 50.8

**N1636**

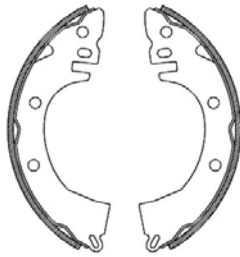

203.2 x 35.0

**N1653**

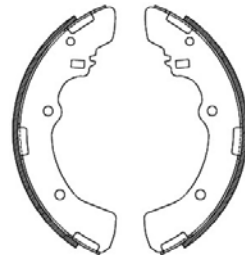

254.0 x 50.0

**N1677**



180.0 x 35.0

**N3009**

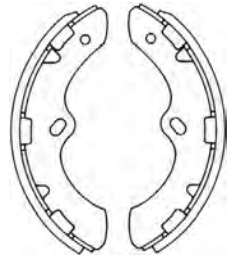

**N1821**

228.6 x 62.0

**N3010**

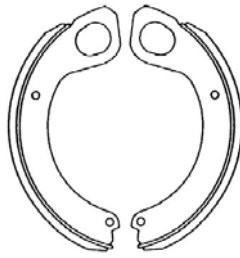

203.2 x 51.0

**N3029**

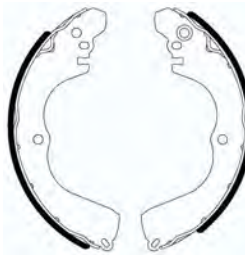

**N1796**

228.6 x 30.0

**N3030**

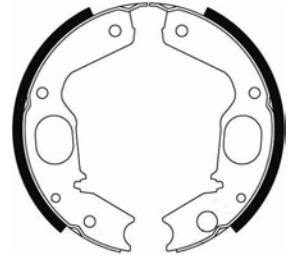

**N1797**

200.0 x 38.0

**N3068**

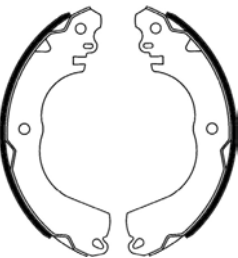

**N1862**

203.2 x 31.5

**N3073**

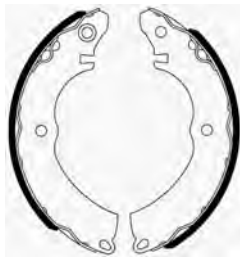

**N1867**

203.2 x 30.0

**N3080**

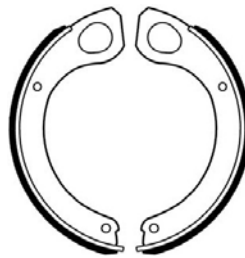

**N1836**

304.8 x 75.0

**N3086**

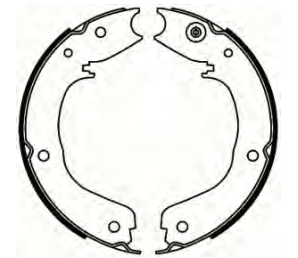

**N1860**

200.0 x 34.0



## MITSUBISHI

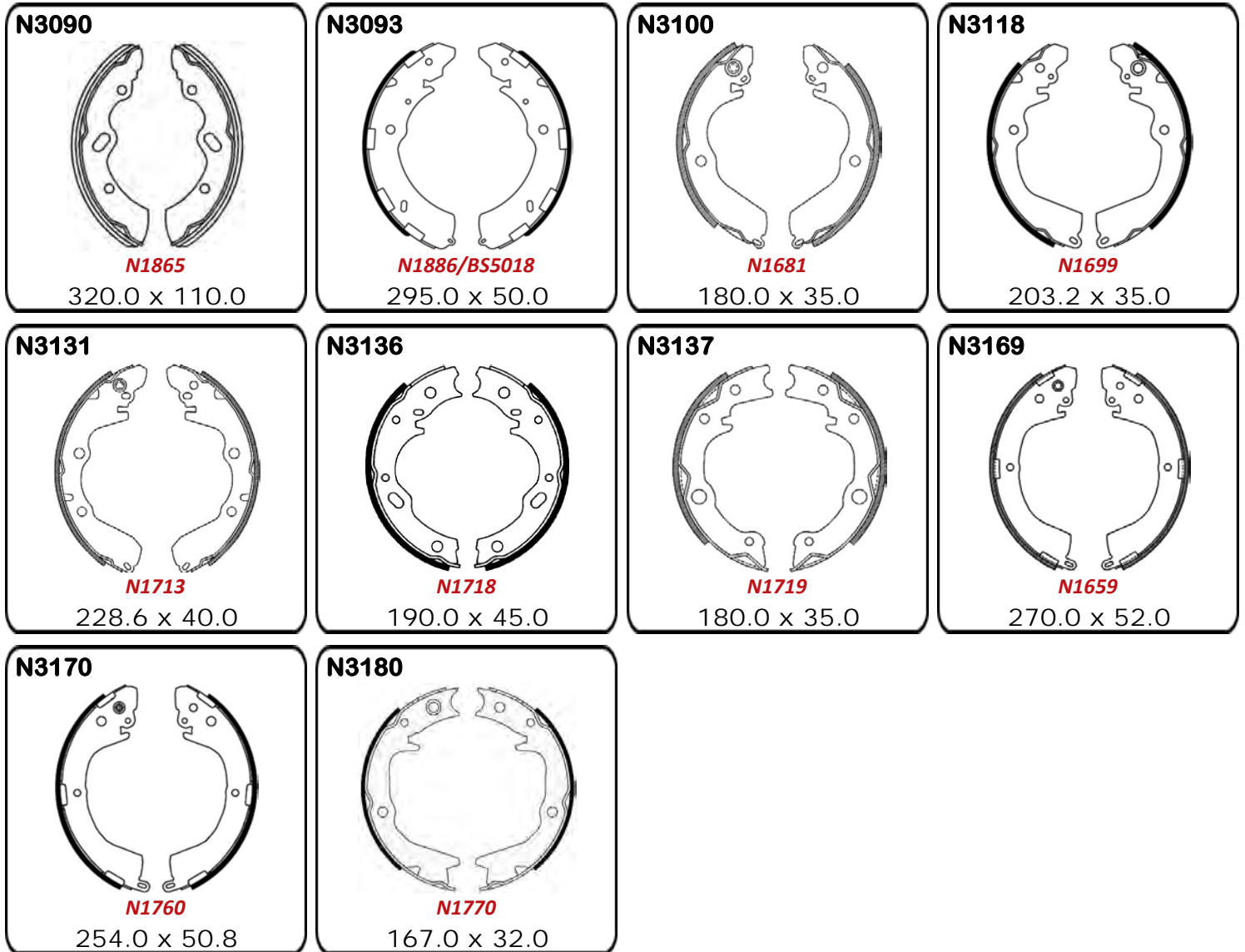

## MORGAN

<p><b>4-4</b> 600 2 Seater, 4 Seater Roadster</p>	<p>1969 - 83</p>	<p></p>	<p><b>N1002</b></p>	<p>228.6 x 44.4</p>
---	------------------	---------	---------------------	---------------------



## MORGAN

### Plus 4

Plus 4	1966 - 68			<b>N1002</b>	228.6 x 44.4
--------	-----------	--	--	--------------	--------------

### Plus 8

Plus 8	1968 - 73			<b>N1002</b>	228.6 x 44.4
--------	-----------	--	--	--------------	--------------

### N1002

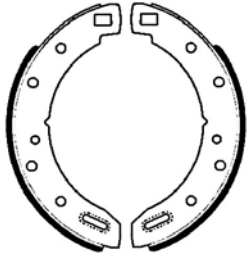

228.6 x 44.4

## MORRIS

### 1000

J2 MESSENGER	1955 - 58	<b>N1325</b>	254.0 x 44.4	<b>N1325</b>	254.0 x 44.4
JB VAN	1958 - 62	<b>N1234</b>	228.6 x 38.1	<b>N1234</b>	228.6 x 38.1
Van & Ute	1958 - 64	<b>N1230</b>	203.2 x 38.1	<b>N1227</b>	177.8 x 31.7
J4 MESSENGER	1963 - 64	<b>N1145</b>	228.6 x 63.5	<b>N1002</b>	228.6 x 44.4

### 1100

Sedan	1964 - 69			<b>N1232</b>	203.2 x 31.7
-------	-----------	--	--	--------------	--------------

### 1300 & 1500

Sedan & Wagon	1969 - 72			<b>N1324</b>	203.2 x 31.7
---------------	-----------	--	--	--------------	--------------

### Cooper & Clubman

Cooper & Clubman GT	1961 - 73			<b>N1332</b>	177.8 x 31.7
---------------------	-----------	--	--	--------------	--------------

### Major

Major & Elite Sedan	1958 - 64	<b>N1234</b>	228.6 x 38.1	<b>N1230</b>	203.2 x 38.1
---------------------	-----------	--------------	--------------	--------------	--------------

### Mini

850 Saloon	1961 - 7/68	<b>N1332</b>	177.8 x 31.7	<b>N1332</b>	177.8 x 31.7
Van	1964 - 7/68	<b>N1332</b>	177.8 x 31.7	<b>N1332</b>	177.8 x 31.7
1100 Saloon, Mini K, Clubman, Mini Moke	1966 - 73	<b>N1333</b>	177.8 x 38.1	<b>N1332</b>	177.8 x 31.7
Van, Mini K Van & Clubman Van	8/1968 on	<b>N1332</b>	177.8 x 31.7	<b>N1332</b>	177.8 x 31.7



## MORRIS

### Minor

8 HP	1949 - 57	<b>N1226</b>	177.8 x 31.7	<b>N1226</b>	177.8 x 31.7
1000CC	1958 - 62	<b>N1226</b>	177.8 x 31.7	<b>N1227</b>	177.8 x 31.7

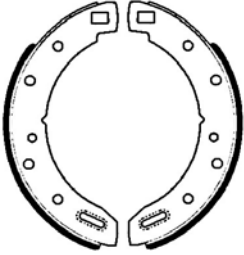
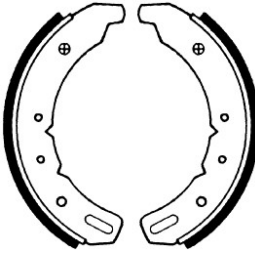
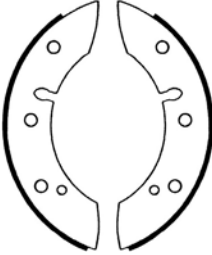
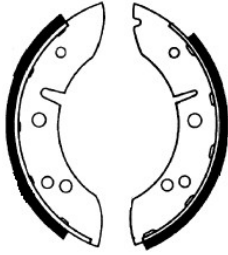
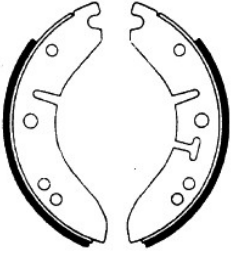
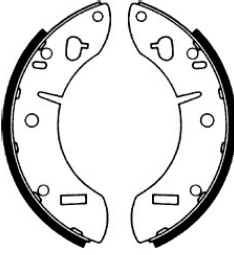
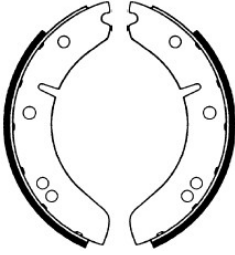
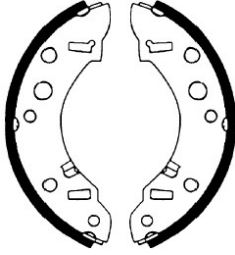
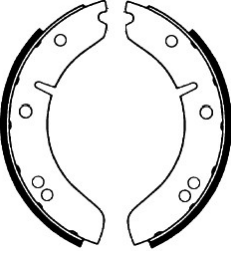
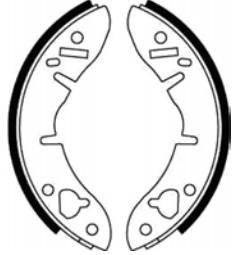
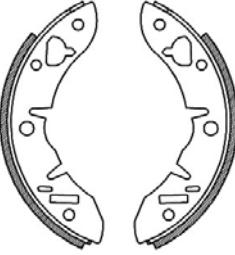
<p><b>N1002</b></p>  <p>228.6 x 44.4</p>	<p><b>N1145</b></p>  <p>228.6 x 63.5</p>	<p><b>N1226</b></p>  <p>177.8 x 31.7</p>	<p><b>N1227</b></p>  <p>177.8 x 31.7</p>
<p><b>N1230</b></p>  <p>203.2 x 38.1</p>	<p><b>N1232</b></p>  <p>203.2 x 31.7</p>	<p><b>N1234</b></p>  <p>228.6 x 38.1</p>	<p><b>N1324</b></p>  <p>203.2 x 31.7</p>
<p><b>N1325</b></p>  <p>254.0 x 44.4</p>	<p><b>N1332</b></p>  <p>177.8 x 31.7</p>	<p><b>N1333</b></p>  <p>177.8 x 38.1</p>	





## NISSAN

### 120Y

All Models With Imported Brakes	1974 - 79			<b>N1043</b>	203.2 x 35.0
Sedan With PBR Brakes	1977 - 79			<b>N1379</b>	203.2 x 35.0
VB310 Van	1979 - 83			<b>N1387</b>	203.2 x 35.0

### 180B

All Models	1972 - 79			<b>N1339</b>	228.6 x 40.0
------------	-----------	--	--	--------------	--------------

### 200B

Sedan With Girlock Brakes	1977 - 79			<b>N1344</b>	228.6 x 44.4
Wagon With Imported Brakes	1977 - 79			<b>N1386</b>	228.6 x 40.0
SSS Sedan With Imported Brakes	1978 - 79			<b>N1386</b>	228.6 x 40.0
Sedan & Wagon With Girlock Brakes	8/1979 - 81			<b>N1384</b>	228.6 x 44.4

### 240C

240C	1971 - 72			<b>N1361</b>	240.0 x 50.0
------	-----------	--	--	--------------	--------------

### 240K

240K	1973 - 78			<b>N1339</b>	228.6 x 40.0
------	-----------	--	--	--------------	--------------

### 240Z

Sports Coupe	1971 - 74			<b>N1350</b>	228.6 x 40.0
--------------	-----------	--	--	--------------	--------------

### 260C

260C	1973 - 75			<b>N1361</b>	240.0 x 50.0
------	-----------	--	--	--------------	--------------

### 260Z

260Z Coupe	1974 - 76			<b>N1339</b>	228.6 x 40.0
260Z Coupe	8/76 - 78			<b>N1350</b>	228.6 x 40.0
260Z Coupe Some	1978			<b>N1386</b>	228.6 x 40.0

### 280C

280C	1978 - 79			<b>N1361</b>	240.0 x 50.0
------	-----------	--	--	--------------	--------------

### 320/520/521

All Models	1962 - 70	<b>N1074</b>	254.0 x 45.0	<b>N1075</b>	254.0 x 45.0
------------	-----------	--------------	--------------	--------------	--------------

### 1000 & 1200

1000, 1200	1967 - 74	<b>N1042</b>	203.2 x 35.0	<b>N1043</b>	203.2 x 35.0
1200 B110 COUPE	1970 - 74			<b>N1043</b>	203.2 x 35.0

### 1600

510 Sedan & Wagon	1968 - 72			<b>N1339</b>	228.6 x 40.0
-------------------	-----------	--	--	--------------	--------------

### 2000

Sedan & Sports	1967 - 70			<b>N1079</b>	228.6 x 40.0
----------------	-----------	--	--	--------------	--------------

### 620

Ute, Van 1.5L Drum/Drum	1972 - 8/78	<b>N1074</b>	254.0 x 45.0	<b>N1075</b>	254.0 x 45.0
Ute, Van 1.5L Drum/Drum	9/77 - 1980	<b>N1390</b>	260.0 x 50.0	<b>N1075</b>	254.0 x 45.0
Ute, Van 1.5L Disc/Drum	1978 - 80			<b>N1075</b>	254.0 x 45.0



## NISSAN

### 720

1.5 & 1.6L	1980 - 11/81	<b>N1390</b>	260.0 x 50.0	<b>N1400</b>	254.0 x 45.0
1.8 & 2.2L	1980 - 7/81			<b>N1584</b>	254.0 x 45.0
1.8 & 2.2L	8/1981 - 1982			<b>N1584</b>	254.0 x 45.0
1.8 & 2.2L	1/1983 - 8/85			<b>N1584</b>	254.0 x 45.0

### Atlas

S41	92 - 97			<b>N3177</b>	320.0 x 75.0
-----	---------	--	--	--------------	--------------

### B120

1000, 1200 Ute	1968 - 84	<b>N1042</b>	203.2 x 35.0	<b>N1043</b>	203.2 x 35.0
----------------	-----------	--------------	--------------	--------------	--------------

### Bluebird

410, 411	1964 - 67	<b>N1078</b>	228.6 x 40.0	<b>N1079</b>	228.6 x 40.0
910 Sedan & Wagon	1980 - 83			<b>N1384</b>	228.6 x 44.4
910 Sedan & Wagon 4WD Handbrake	1980 - 86		<b>Handbrake</b>	<b>N1443</b>	177.0 x 26.0
910 Sedan & Wagon	1983 - 86			<b>N1384-3</b>	228.6 x 44.4

### C120

All Models	1980 - 86			<b>N1386</b>	228.6 x 40.0
------------	-----------	--	--	--------------	--------------

### Caball

C140, C141 2000 Kg Tray	1968 - 76	<b>N1340</b>	292.0 x 55.0	<b>N1341</b>	292.0 x 55.0
C240 2000Kg Tray	1976 - 80	<b>N1516</b>	300.0 x 70.0	<b>N1517</b>	300.0 x 55.0
Handbrake Some	1980 - 81		<b>Handbrake</b>	<b>N1548</b>	160.0 x 35.0
C340 2000Kg Tray	1980 - 81	<b>N1515</b>	320.0 x 65.0	<b>N1515</b>	320.0 x 65.0

### Cabstar

SD22	1980 - 81			<b>N1400</b>	254.0 x 45.0
PF22	1981 - 84			<b>N1597</b>	270.0 x 50.0
H40 3 TON . ED33, FD33T Handbrake	12/1981 - 11/86		<b>Handbrake</b>	<b>N1582</b>	203.2 x 45.0
HA40 All Others Handbrake	1981 on		<b>Handbrake</b>	<b>N1548</b>	160.0 x 35.0
H40 Dual-Cab	1982 on	<b>N1596</b>	300.0 x 75.0	<b>N1596</b>	300.0 x 75.0
H40 Tray	1982 - 2/89	<b>N1515</b>	320.0 x 65.0	<b>N1515</b>	320.0 x 65.0
HA40 LWB, ED33 F5D, FD35, FD35T Handbrake	11/1986 - 2/89		<b>Handbrake</b>	<b>N1547</b>	203.2 x 45.0
H40 Tray LWB	2/1989 on	<b>N3141</b>	320.0 x 75.0	<b>N3141</b>	320.0 x 75.0
H41 Twin Cab	1992 - 95	<b>N3176</b>	300.0 x 75.0	<b>N3176</b>	300.0 x 75.0
H41 Standard Cab	1992 - 97	<b>N3177</b>	320.0 x 75.0	<b>N3177</b>	320.0 x 75.0

### Cedric

Sedan & Wagon	1963 - 66	<b>N1074</b>	254.0 x 45.0	<b>N1075</b>	254.0 x 45.0
---------------	-----------	--------------	--------------	--------------	--------------

### Civilian

22 Seater Bus	1984 - 93	<b>N1515</b>	320.0 x 65.0	<b>N1515</b>	320.0 x 65.0
W40	1993 - 97			<b>N3177</b>	320.0 x 75.0



## NISSAN

### *E20*

Van & Microbus	1974 - 78	<b>N1514</b>	250.0 x 50.0	<b>N1075</b>	254.0 x 45.0
Van & Microbus	4/1978 - 1980	<b>N1390</b>	260.0 x 50.0	<b>N1075</b>	254.0 x 45.0

### *Echo*

Van 1.9L	1963 - 70	<b>N1340</b>	292.0 x 55.0	<b>N1341</b>	292.0 x 55.0
----------	-----------	--------------	--------------	--------------	--------------

### *Fairlady*

SP310 1500cc	1963 - 65	<b>N1076</b>	203.2 x 36.0	<b>N1077</b>	203.2 x 36.0
--------------	-----------	--------------	--------------	--------------	--------------

### *Gazelle*

S12 Coupe & Lift Back	1984 - 85			<b>N1386</b>	228.6 x 40.0
-----------------------	-----------	--	--	--------------	--------------

### *Homer*

T640, T641 Truck 1.6L	8/69 - 72	<b>N1347</b>	250.0 x 50.0	<b>N1347</b>	250.0 x 50.0
T20 1.6L	9/72 - 76	<b>N1514</b>	250.0 x 50.0	<b>N1075</b>	254.0 x 45.0
PF20 2.0L	5/76 - 78	<b>N1446</b>	270.0 x 50.0	<b>N1404</b>	270.0 x 50.0
PF20	5/78 - 81	<b>N1447</b>	280.0 x 60.0	<b>N1404</b>	270.0 x 50.0

### *Micra*

K11 1.3L Hatch	5/1995 on			<b>N3139</b>	180.0 x 25.0
----------------	-----------	--	--	--------------	--------------

### *Navara*

4WD 4 Cyl	9/85 - 10/89			<b>N1652</b>	254.0 x 60.0
2WD 4 Cyl	9/85 - 10/89			<b>N1612</b>	254.0 x 45.0
4WD 4 Cyl	10/89 on			<b>N3140</b>	295.0 x 50.0
2WD 4 Cyl	10/89 on			<b>N1657</b>	260.0 x 50.0
2WD	1992 on			<b>N1657</b>	260.0 x 50.0
4WD	1992 on			<b>N3140</b>	295.0 x 50.0
D40	2005 on			<b>N3213</b>	295.0 x 56.2

### *Nomad*

Van	1978 - 89			<b>N1584</b>	254.0 x 45.0
Van	1989 on			<b>N1656</b>	228.6 x 40.0

### *Pathfinder*

WD21	8/86 - 10/89			<b>N1652</b>	254.0 x 60.0
WD21	10/89 - 7/92			<b>N1657</b>	260.0 x 50.0
WD21	7/1992 on			<b>N1657</b>	260.0 x 50.0
VG33E 4WD	11/1995 on			<b>N3140</b>	295.0 x 50.0

### *Patrol*

G60	1962 - 80	<b>N1340</b>	292.0 x 55.0	<b>N1341</b>	292.0 x 55.0
G61	1979 - 81	<b>N1340</b>	292.0 x 55.0	<b>N1404</b>	270.0 x 50.0
MQ 160 Series	1981 - 83		270.0 x 50.0	<b>N1404</b>	270.0 x 50.0
Handbrake	1981 on		<b>Handbrake</b>	<b>N1547</b>	203.2 x 45.0
MQ 160 Series	1983 - 86		270.0 x 50.0	<b>N1597</b>	270.0 x 50.0
GQ With Rear Drums	1987 - 91		295.0 x 60.0	<b>N1668</b>	295.0 x 60.0



## NISSAN

### *Pintara*

U12 FWD Some	1989 - 92			<b>N1656</b>	228.6 x 40.0
--------------	-----------	--	--	--------------	--------------

### *Prairie*

BM10, 7 Seater Wagon	1985 - 85			<b>N1598</b>	203.2 x 35.0
----------------------	-----------	--	--	--------------	--------------

### *Pulsar*

N10	1980 - 82			<b>N1387</b>	203.2 x 35.0
N12 All With PBR Brakes	11/82 - 87			<b>N1399</b>	180.0 x 35.0
N12 All With Imported Brakes	1982 - 84			<b>N1672</b>	180.0 x 35.0
N12 EXA Turbo	1983 - 85			<b>N1399</b>	180.0 x 35.0
VB Van	1983 - 85			<b>N1399</b>	180.0 x 35.0
Van	1985 - 89			<b>N1598</b>	203.2 x 35.0
N13 1.8L	1987 - 92			<b>N1672</b>	180.0 x 35.0
N13 1.6L	1987 - 91			<b>N1598</b>	203.2 x 35.0
KN13 EXA	1987 - 89			<b>N1598</b>	203.2 x 35.0
N14	1991 - 11/95			<b>N3116</b>	180.0 x 30.0
N15 1.6L	11/1995 on			<b>N3116</b>	180.0 x 30.0
N16 Sedan	6/01 - 8/01			<b>N3197</b>	203.2 x 35.0
N16 Sedan With Sumitomo Rear	9/01 on			<b>N1598</b>	203.2 x 35.0

### *S-Cargo*

1500 G20	1989 - 94			<b>N1598</b>	203.2 x 35.0
----------	-----------	--	--	--------------	--------------

### *Serena*

C23 PMV	10/1992 on			<b>N3129</b>	260.0 x 40.0
---------	------------	--	--	--------------	--------------

### *Skyline*

C210	1978 - 81			<b>N1386</b>	228.6 x 40.0
R30	1981 - 84			<b>N1386</b>	228.6 x 40.0

### *Stanza*

GL, GLX With Imported Brakes	1978 - 79			<b>N1386</b>	228.6 x 40.0
GL, GLX With Girlock Brakes	1979 - 83			<b>N1384</b>	228.6 x 44.4

### *Sunny*

Sedan & Wagon	1979 - 81			<b>N1387</b>	203.2 x 35.0
Van	1979 - 83			<b>N1387</b>	203.2 x 35.0

### *Terrano*

R20 4WD	3/1997 on			<b>N3031</b>	254.0 x 55.0
R20 4x4 Wagon	3/1997 on			<b>N3031</b>	254.0 x 55.0

### *Tiida*

C11	9/2004 on			<b>N3068</b>	203.2 x 31.5
-----	-----------	--	--	--------------	--------------

### *Urvan*

E23 1.6, 2.0L	7/1980 - 4/82			<b>N1400</b>	254.0 x 45.0
E23 1.8, 2.0, 2.3L	4/1982 - 11/86			<b>N1584</b>	254.0 x 45.0



## NISSAN

### Urvan

E24	11/1986 on		<b>N1657</b>	260.0 x 50.0
-----	------------	--	--------------	--------------

### Vanette

C120	1980 - 82		<b>N1386</b>	228.6 x 40.0
Van	1982 - 86		<b>N1621</b>	180.0 x 50.0
GC22	1982 - 84		<b>N1656</b>	228.6 x 40.0
Van	1987 - 89		<b>N1584</b>	254.0 x 45.0

### X-Trail

T30 2.5L	03 on	<b>Handbrake</b>	<b>N3078</b>	172.0 x 20.0
----------	-------	------------------	--------------	--------------

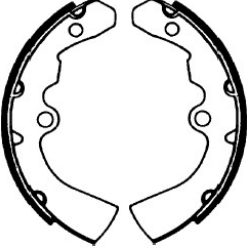
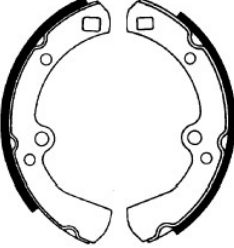
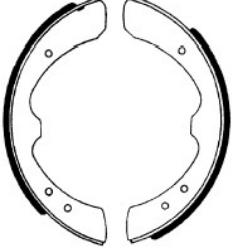
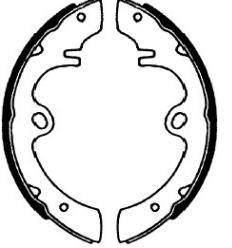
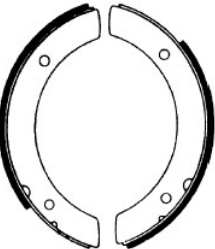
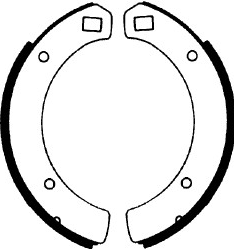
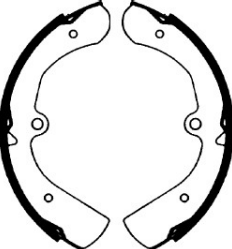
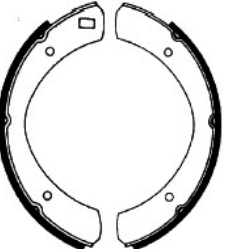
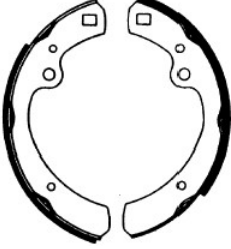
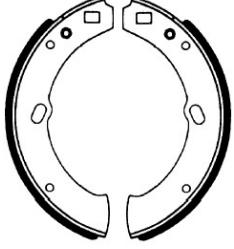
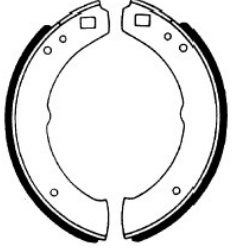
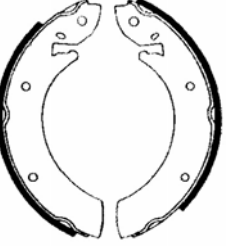
<p><b>N1042</b></p>  <p>203.2 x 35.0</p>	<p><b>N1043</b></p>  <p>203.2 x 35.0</p>	<p><b>N1074</b></p>  <p>254.0 x 45.0</p>	<p><b>N1075</b></p>  <p>254.0 x 45.0</p>
<p><b>N1076</b></p>  <p>203.2 x 36.0</p>	<p><b>N1077</b></p>  <p>203.2 x 36.0</p>	<p><b>N1078</b></p>  <p>228.6 x 40.0</p>	<p><b>N1079</b></p>  <p>228.6 x 40.0</p>
<p><b>N1339</b></p>  <p>228.6 x 40.0</p>	<p><b>N1340</b></p>  <p>292.0 x 55.0</p>	<p><b>N1341</b></p>  <p>292.0 x 55.0</p>	<p><b>N1344</b></p>  <p>228.6 x 44.4</p>





## NISSAN

**N1347**

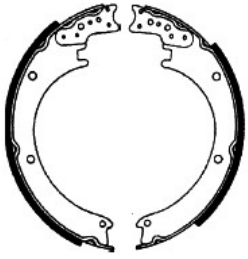

250.0 x 50.0

**N1350**

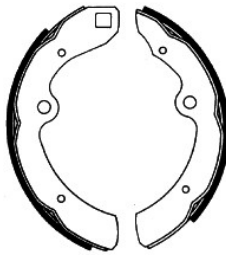

228.6 x 40.0

**N1361**

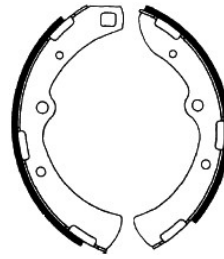

240.0 x 50.0

**N1379**

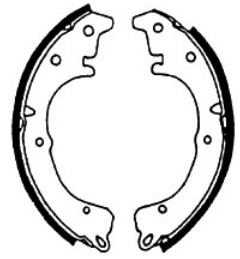

203.2 x 35.0

**N1384**

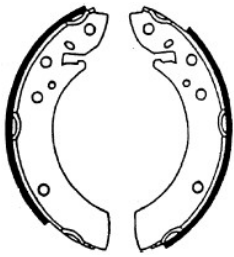

228.6 x 44.4

**N1384-3**

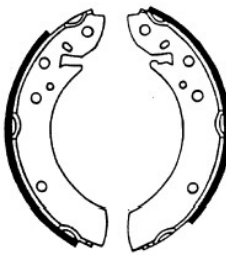

228.6 x 44.4

**N1386**

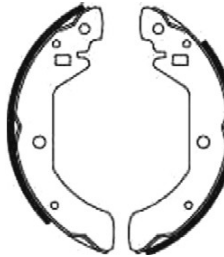

228.6 x 40.0

**N1387**

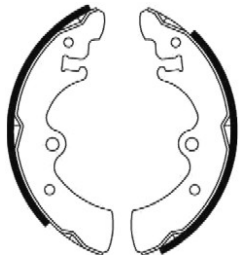

203.2 x 35.0

**N1390**

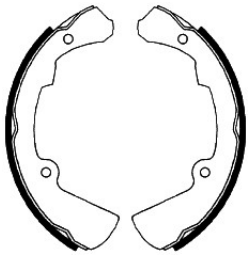

260.0 x 50.0

**N1399**

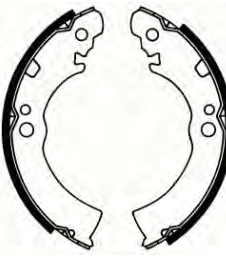

180.0 x 35.0

**N1400**

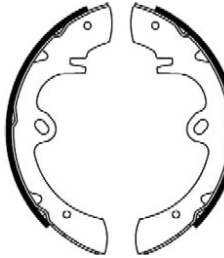

254.0 x 45.0

**N1404**

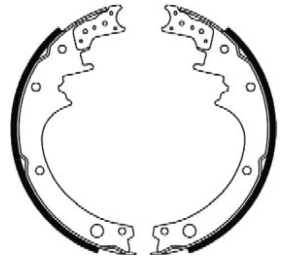

270.0 x 50.0

**N1443**

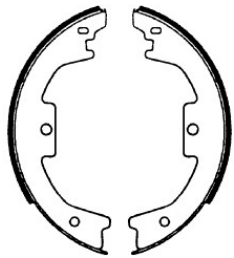

177.0 x 26.0

**N1446**

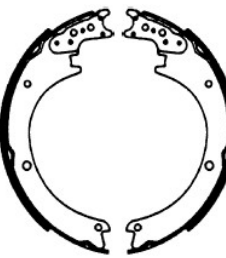

270.0 x 50.0

**N1447**

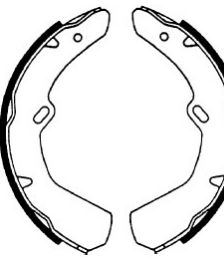

280.0 x 60.0

**N1514**

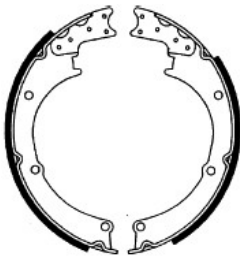

250.0 x 50.0



## NISSAN

**N1515**

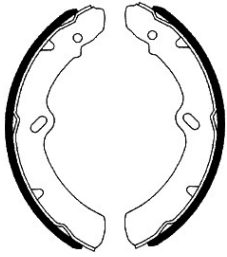

320.0 x 65.0

**N1516**

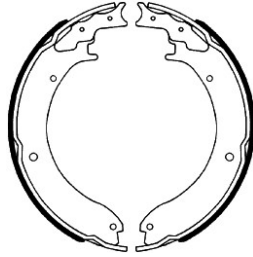

300.0 x 70.0

**N1517**

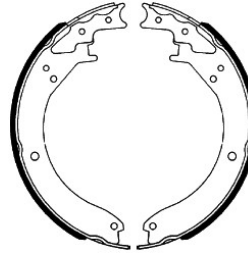

300.0 x 55.0

**N1547**

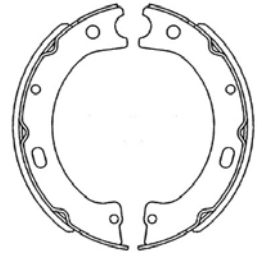

203.2 x 45.0

**N1548**

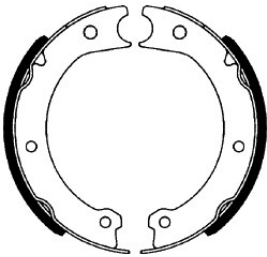

160.0 x 35.0

**N1582**

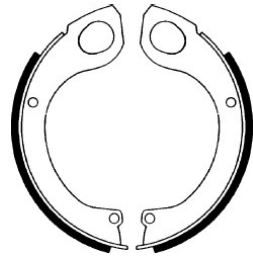

203.2 x 45.0

**N1584**

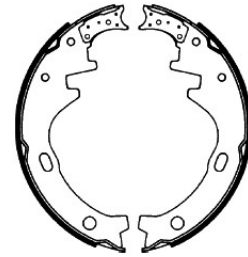

254.0 x 45.0

**N1596**

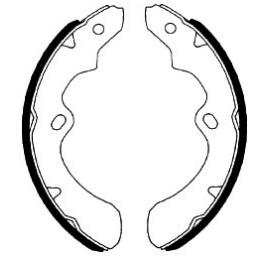

300.0 x 75.0

**N1597**

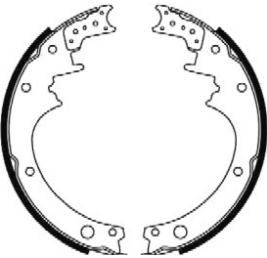

270.0 x 50.0

**N1598**

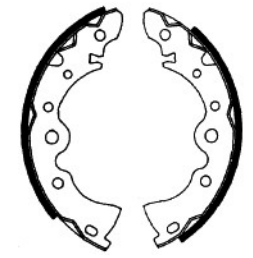

203.2 x 35.0

**N1612**

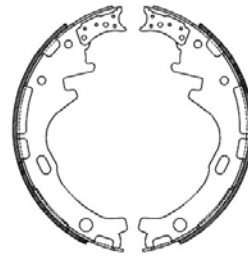

254.0 x 45.0

**N1621**

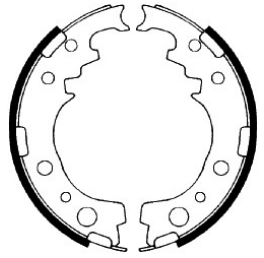

180.0 x 50.0

**N1652**

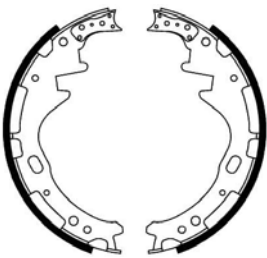

254.0 x 60.0

**N1656**

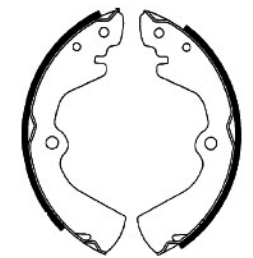

228.6 x 40.0

**N1657**

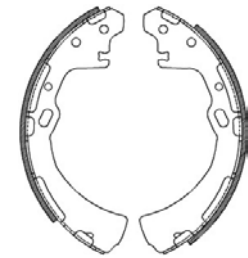

260.0 x 50.0

**N1668**

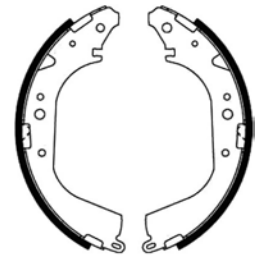

295.0 x 60.0



## NISSAN

**N1672**

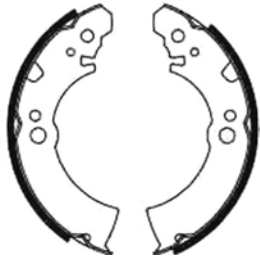

180.0 x 35.0

**N3031**



**N1800**

254.0 x 55.0

**N3068**

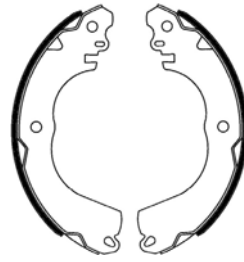

**N1862**

203.2 x 31.5

**N3078**

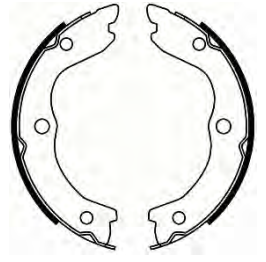

**N1834**

172.0 x 20.0

**N3116**

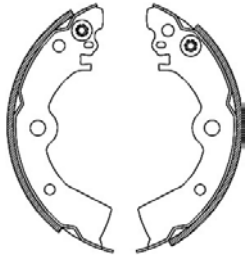

**N1697**

180.0 x 30.0

**N3129**

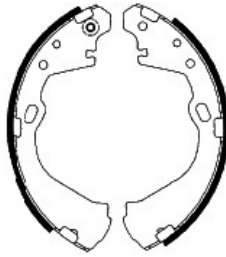

**N1711**

260.0 x 40.0

**N3139**

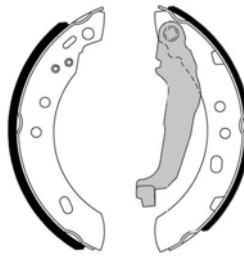

**N1725**

180.0 x 25.0

**N3140**

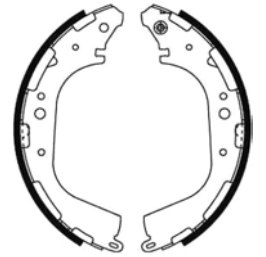

**N1726**

295.0 x 50.0

**N3141**

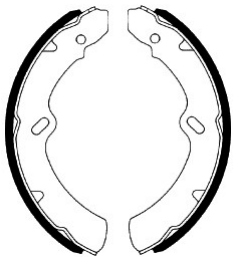

**N1727**

320.0 x 75.0

**N3176**

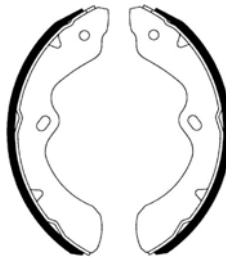

**N1766**

300.0 x 75.0

**N3177**

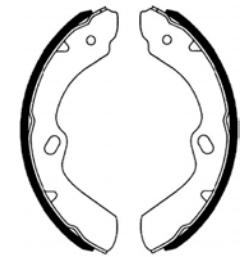

**N1767**

320.0 x 75.0

**N3197**

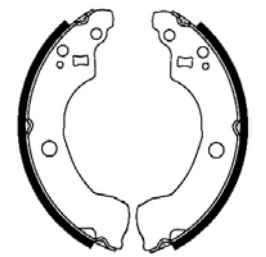

**N1792**

203.2 x 35.0

**N3213**

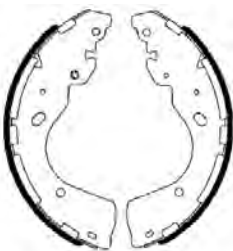

**N1893**

295.0 x 56.2



## Oka

### Oka

Handbrake	2009 on			<b>N3221</b>	228.6 x 75.2
-----------	---------	--	--	--------------	--------------

**N3221**



**No Profile Available**

*N1890*

228.6 x 75.2

## PEUGEOT

### 205

Except Gti With Bendix Rear Brakes	1983 on			<b>N3149</b>	180.0 x 32.0
Gti 1.9L	1987			<b>N3032</b>	180.0 x 42.0
Gti 1.6L	T0 4/1994			<b>N3032</b>	180.0 x 42.0

### 206

1.6i & 1.9D With Bendix Brakes	1998 on			<b>N3034</b>	180.0 x 32.0
--------------------------------	---------	--	--	--------------	--------------

### 305

With Girling Rear Brakes	1983 - 87			<b>N1354-1</b>	228.6 x 40.0
GL, GR, GT, GLD	1984 - 87			<b>N1370</b>	228.6 x 40.0

### 306

1.0L, 1.1L Non ABS	9/91 on			<b>N3085</b>	165.0 x 32.0
1.4, 1.6, 1.8i, 1.9D With Bendix Rear Brakes	1993 - 4/97			<b>N3019</b>	180.0 x 32.0
1.1L 1.4L, 1.6L, 1.8L, 1.9D/T Bendix Rear Brakes	4/1993 - 4/97			<b>N3033</b>	228.6 x 42.0
Sedan With Lucas Brakes	1993 - 4/97			<b>N3018</b>	180.0 x 30.0
XR, XT, 1.8 & 2.0L	10/94 on			<b>N3149</b>	180.0 x 32.0
1.4, 1.6 Estate & 1.9TD	5/1997 - 00			<b>N3033</b>	228.6 x 42.0

### 309

Except Gti With Bendix Rear Brakes	1987 on			<b>N3149</b>	180.0 x 32.0
Except Gti With Girling Rear Brakes	1987 on			<b>N3032</b>	180.0 x 42.0

### 403

Sedan	1958 - 60	<b>N1251</b>	255.0 x 50.0	<b>N1280</b>	255.0 x 35.0
-------	-----------	--------------	--------------	--------------	--------------



## PEUGEOT

### 403

Wagon	1958 - 63			<b>N1477</b>	280.0 x 50.0
-------	-----------	--	--	--------------	--------------

### 404

Sedan From 4108665 to 4388565	1963 - 67	<b>N1479</b>	255.0 x 60.0	<b>N1280</b>	255.0 x 35.0
Sedan From 4388566 to 5057592	1963 - 67	<b>N1480</b>	280.0 x 65.0	<b>N1280</b>	255.0 x 35.0
Sedan From 5057593 to 5100000	1963 - 67			<b>N1478</b>	255.0 x 45.0
Sedan From 5100001 to 5247918	1963 - 67	<b>N1480</b>	280.0 x 65.0	<b>N1478</b>	255.0 x 45.0
Wagon	1963 - 70	<b>N1480</b>	280.0 x 65.0	<b>N1477</b>	280.0 x 50.0

### 405

1.6, 1.9L GE, GL, GR With Bendix Rear Brakes	1987 - 92			<b>N3033</b>	228.6 x 42.0
1.9L With Lucas Rear Brakes	1987 - 96			<b>N3035</b>	228.6 x 42.0
1.6, 1.9L GE, GL, GR	1987 on			<b>N1354-1</b>	228.6 x 40.0
1.4, 1.6, 1.8, 1.9L Estate With Lucas Rear Brakes	1992 - 96			<b>N3020</b>	228.6 x 42.0

### 406

All Models	1995 on			<b>N3036</b>	228.6 x 40.0
------------	---------	--	--	--------------	--------------

### 504

Wagon	1975 - 83			<b>N1481</b>	255.0 x 45.0
Wagon	1980 - 86			<b>N1680</b>	255.0 x 60.0

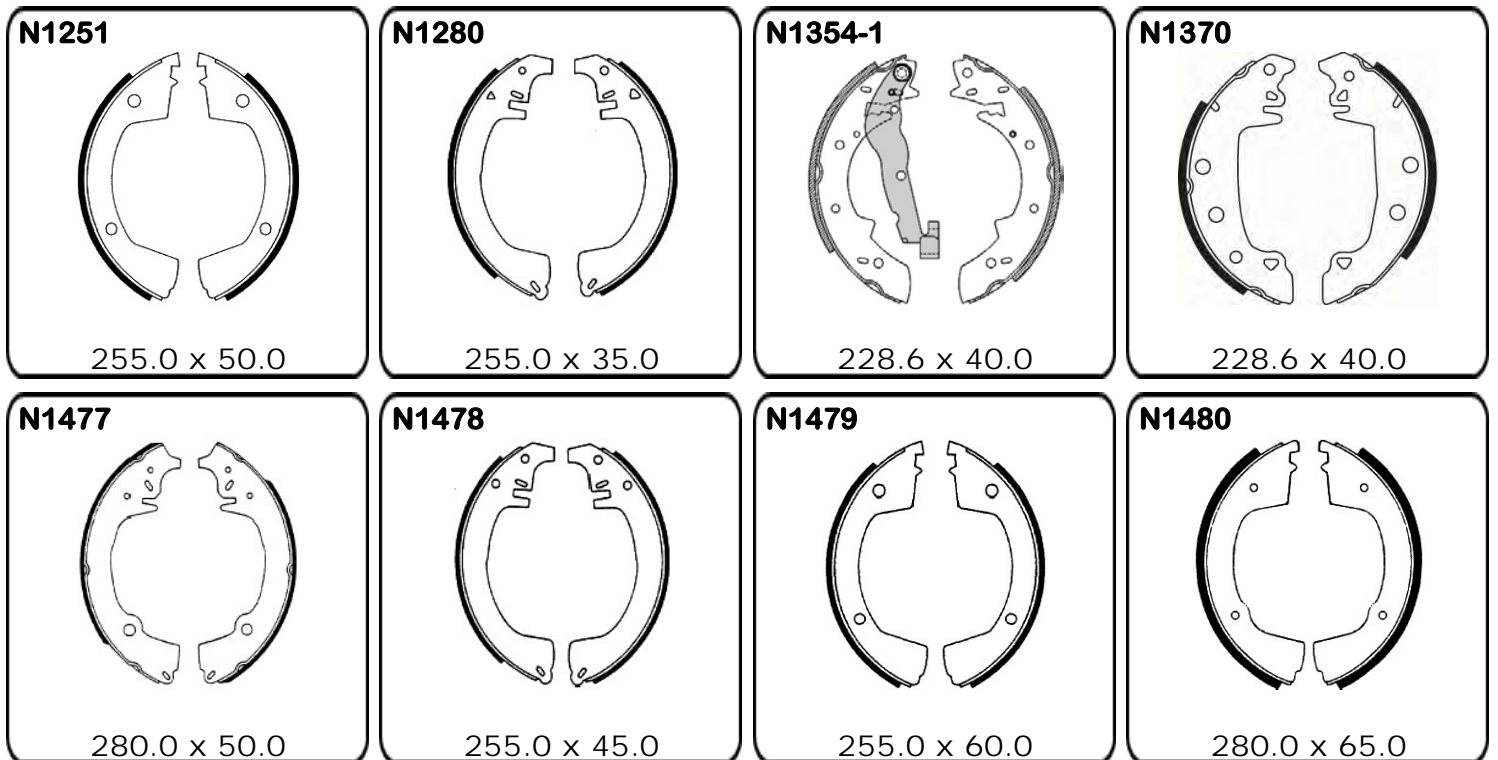





## PEUGEOT

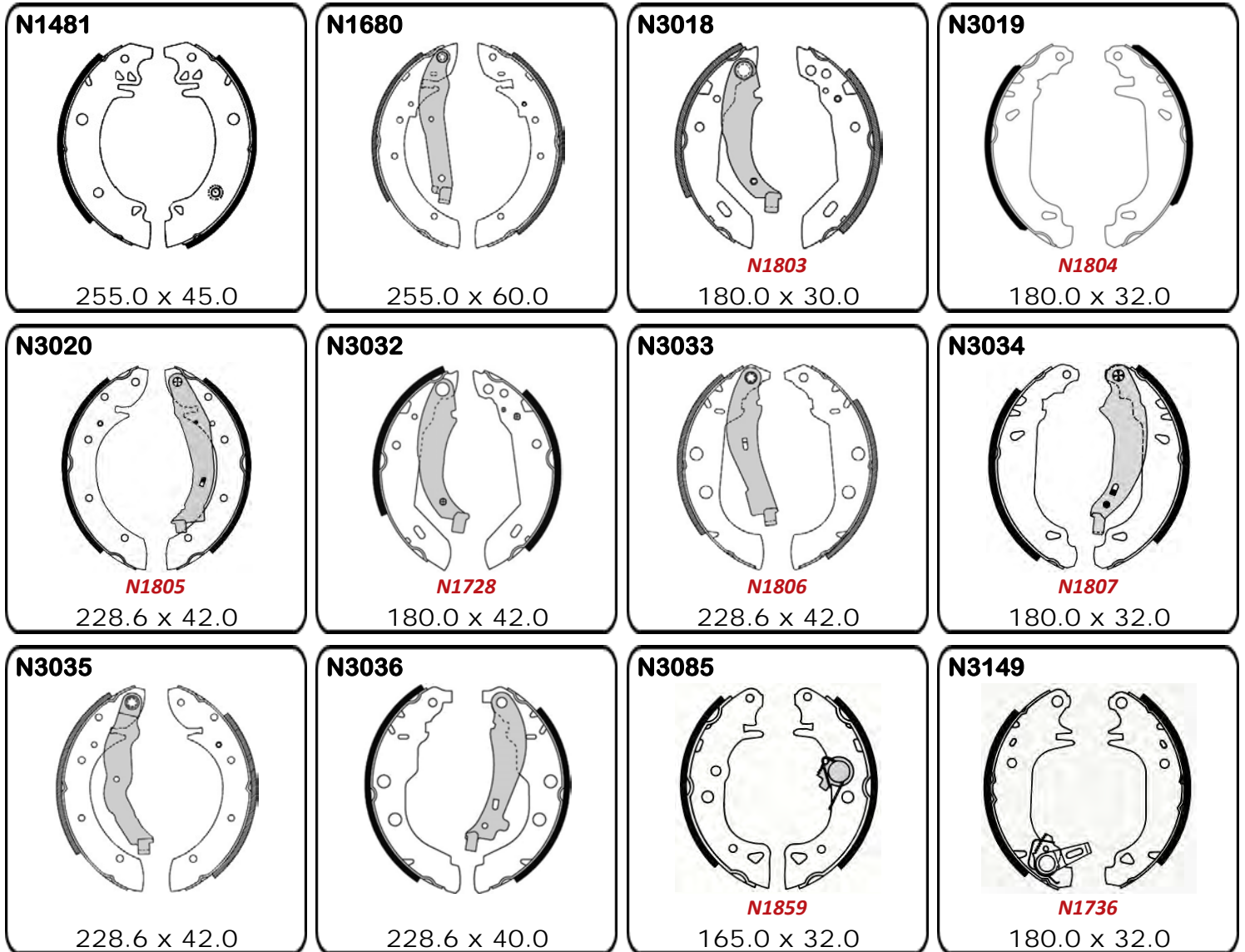

## PONTIAC

### Bonneville

Bonneville	1959 - 64	<b>N1060</b>	279.4 x 63.5	<b>N1061</b>	279.4 x 50.8
------------	-----------	--------------	--------------	--------------	--------------



## PONTIAC

### *Catalina*

Catalina	1959 - 64	<b>N1060</b>	279.4 x 63.5	<b>N1061</b>	279.4 x 50.8
----------	-----------	--------------	--------------	--------------	--------------

### *Early Models*

Early Models	1959 - 64	<b>N1060</b>	279.4 x 63.5	<b>N1061</b>	279.4 x 50.8
--------------	-----------	--------------	--------------	--------------	--------------

### *Executive*

Executive	1959 - 64	<b>N1060</b>	279.4 x 63.5	<b>N1061</b>	279.4 x 50.8
-----------	-----------	--------------	--------------	--------------	--------------

### *GTO*

Coupe Drum/Drum	1964 - 68	<b>N1482</b>	240.0 x 63.5	<b>N1483</b>	240.0 x 50.8
Coupe Disc/Drum	1967 - 73			<b>N1483</b>	240.0 x 50.8

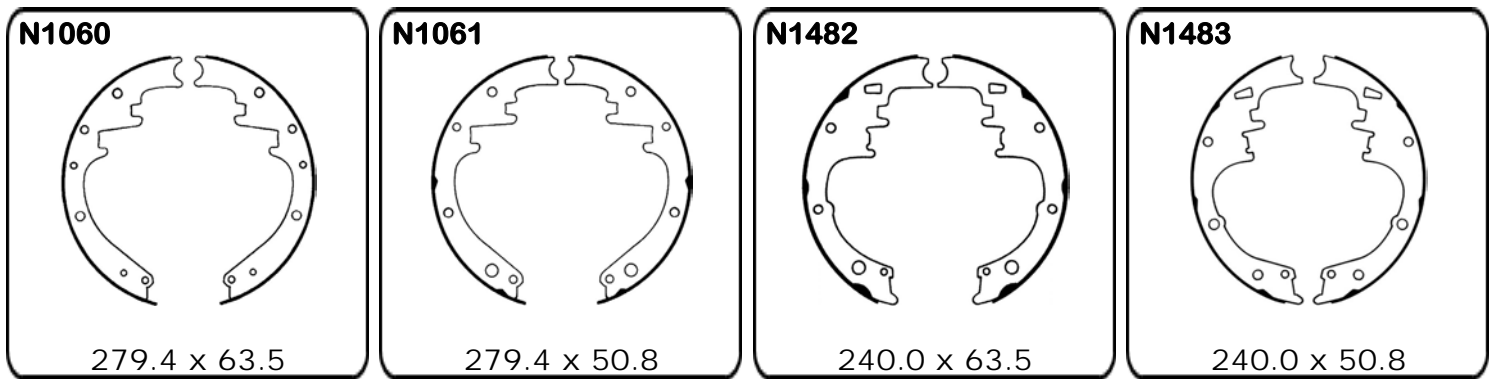

## PROTON

### *Jumbuck*

1.5L	2/2003 on			<b>N3020</b>	228.6 x 42.0
------	-----------	--	--	--------------	--------------

### *Persona*

1.5L	11/1996 - 99			<b>N1677</b>	180.0 x 35.0
1.3L, 1.5L FWD	1999 - 02			<b>N3100</b>	180.0 x 35.0

### *Satria*

3 Door Hatch 1.5L	2/1997 - 00			<b>N1677</b>	180.0 x 35.0
1.3L & 1.5L	2000 on			<b>N3100</b>	180.0 x 35.0

### *Savvy*

1.2L	10/05 on			<b>N3006</b>	180.0 x 31.0
------	----------	--	--	--------------	--------------

### *Wira*

1.5L	1995 on			<b>N1677</b>	180.0 x 35.0
------	---------	--	--	--------------	--------------



## PROTON

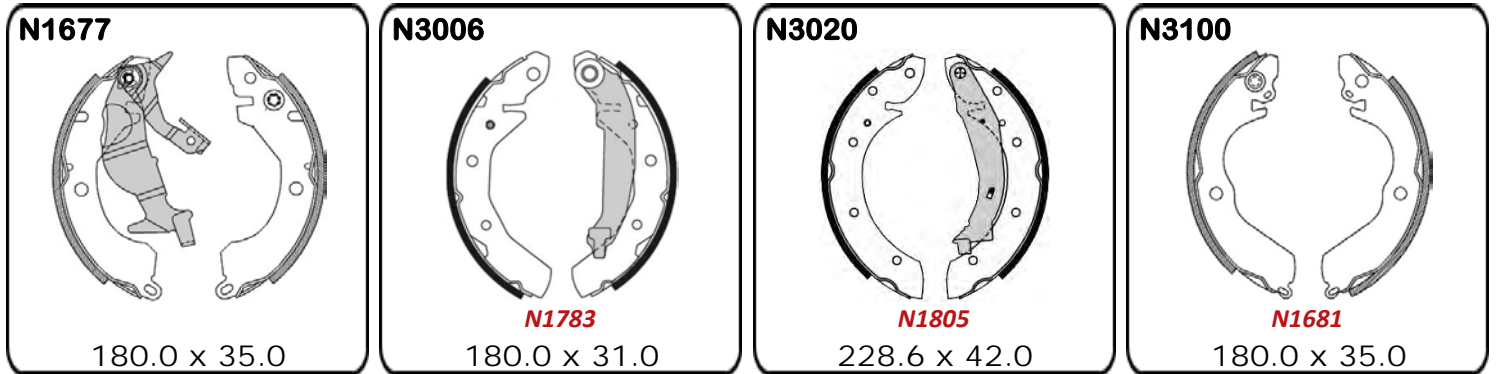

## RAMBLER

### *Ambassador*

80, V8	1960 - 63	<b>N1265</b>	254.0 x 63.5	<b>N1266</b>	254.0 x 44.4
--------	-----------	--------------	--------------	--------------	--------------

### *American*

330	1964 - 65	<b>N1485</b>	228.6 x 50.8	<b>N1485</b>	228.6 x 50.8
440	1966	<b>N1267</b>	228.6 x 63.5	<b>N1268</b>	228.6 x 50.8

### *AMX*

AMX 30	1969 - 70			<b>N1266</b>	254.0 x 44.4
--------	-----------	--	--	--------------	--------------

### *Classic*

6 Cyl	1960 - 63	<b>N1267</b>	228.6 x 63.5	<b>N1268</b>	228.6 x 50.8
V8	1964 - 67	<b>N1265</b>	254.0 x 63.5	<b>N1266</b>	254.0 x 44.4

### *Hornet*

Hornet	1971 - 76			<b>N1266</b>	254.0 x 44.4
--------	-----------	--	--	--------------	--------------

### *Javelin*

70	1968 - 73			<b>N1266</b>	254.0 x 44.4
----	-----------	--	--	--------------	--------------

### *Matador*

Sedan	1971 - 78			<b>N1266</b>	254.0 x 44.4
Wagon	1971 - 78			<b>N1484</b>	254.0 x 63.5

### *Rebel*

10-770	1967 - 71			<b>N1486</b>	254.0 x 44.4
--------	-----------	--	--	--------------	--------------



## RAMBLER

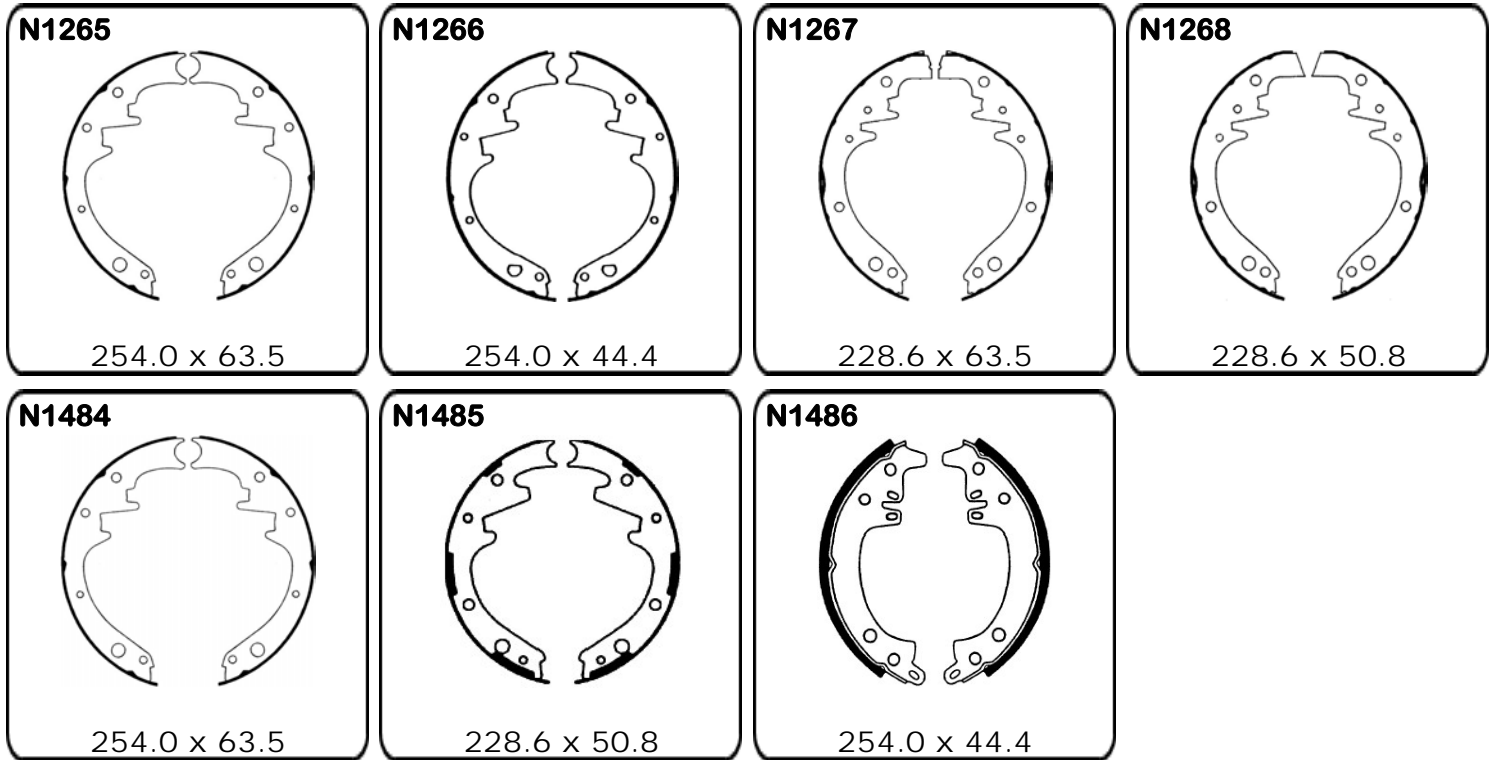

## RENAULT

### 4

R1120, R1123	1962 - 67	<b>N1269</b>	200.0 x 36.0	<b>N1279</b>	160.0 x 25.0
--------------	-----------	--------------	--------------	--------------	--------------

### 12

Wagon With Bendix/DBA Rear Brakes	1970 - 77			<b>N1416</b>	228.6 x 40.0
Wagon With Girling Rear Brakes	1970 - 77			<b>N1370</b>	228.6 x 40.0
Sedan With Bendix/DBA Rear Brakes	1970 - 77			<b>N1355</b>	180.0 x 40.0
Sedan With Girling Rear Brakes	9/1975 - 77			<b>N1455</b>	180.0 x 40.0

### 14

Sedan	1976 - 78			<b>N1467</b>	180.0 x 40.0
Wagon	1976 - 78			<b>N1416</b>	228.6 x 40.0

### 15

TS Coupe	1973 - 76			<b>N1416</b>	228.6 x 40.0
----------	-----------	--	--	--------------	--------------



## RENAULT

### 16

With Self-Adjusting Girling Rear Brakes	1970 - 77			<b>N1354-1</b>	228.6 x 40.0
With Bendix/DBA Rear Brakes	1970 - 77			<b>N1370</b>	228.6 x 40.0
With Girling Rear Brakes	1970 - 77			<b>N1354</b>	228.6 x 40.0
R1154 With Bendix/DBA Rear Brakes	1972			<b>N1416</b>	228.6 x 40.0

### 17

17TL Coupe - Type 1312	1973 - 76			<b>N1370</b>	228.6 x 40.0
17TL Coupe - Type R1318	1976			<b>N1416</b>	228.6 x 40.0

### 18

TL & GTL With Bendix Rear Brakes	4/1978 - 6/82			<b>N1467</b>	180.0 x 40.0
TL & GTL With Girling Rear Brakes	4/1978 - 6/82			<b>N1455</b>	180.0 x 40.0
Wagon	4/1978 - 6/82			<b>N1370</b>	228.6 x 40.0
TL & GTL With Bendix Rear Brakes	7/1982 on			<b>N1467</b>	180.0 x 40.0
TL & GTL With Girling Rear Brakes	7/1982 on			<b>N1455</b>	180.0 x 40.0
Wagon	7/1982 on			<b>N1370</b>	228.6 x 40.0

### 19

1.4, 1.7, 1.9TD, 1.8I With Lucas Rear Brakes	1988 - 96			<b>N3032</b>	180.0 x 42.0
1.4, 1.7, 1.9TD, 1.8I With Bendix rear Brakes	1988 - 96			<b>N3037</b>	180.0 x 40.0
1.7 TXi	4/1990 - 6/96			<b>N3018</b>	180.0 x 30.0
1.8 TXi, 1.9 TD GTD	4/1992 - 5/94			<b>N3041</b>	203.2 x 39.0

### 20

All Models With Bendix Rear Brakes	1975 on			<b>N1370</b>	228.6 x 40.0
All Models With Girling Rear Brakes	1975 - 6/80			<b>N1354-1</b>	228.6 x 40.0

### 21

GTX, RX, TXE 2.0L With Girling Brakes	1986 on			<b>N3032</b>	180.0 x 42.0
---------------------------------------	---------	--	--	--------------	--------------

### 25

With Bendix Rear Brakes	3/84 on			<b>N1370</b>	228.6 x 40.0
With Girling Rear Brakes	3/84 on			<b>N1354-1</b>	228.6 x 40.0

### 30

R30TD With Bendix Rear Brakes	81 - 84			<b>N1370</b>	228.6 x 40.0
R30TD With Girling Rear Brakes	81 - 84			<b>N1354-1</b>	228.6 x 40.0

### 750

750	1956 - 62	<b>N1276</b>	180.0 x 30.0	<b>N1276</b>	180.0 x 30.0
-----	-----------	--------------	--------------	--------------	--------------

### Clio

With Lucas Rear Brakes	1990 - 97			<b>N3032</b>	180.0 x 42.0
With Bendix Rear Brakes	1990 - 97			<b>N3037</b>	180.0 x 40.0
With Bosch Rear Brakes	1998 on			<b>N3038</b>	180.0 x 42.0

### Dauphine

R1090	1957 - 60	<b>N1275</b>	230.0 x 30.0	<b>N1275</b>	230.0 x 30.0
-------	-----------	--------------	--------------	--------------	--------------





## RENAULT

### Dauphine

R1091	1963 - 63	<b>N1277</b>	230.0 x 35.0	<b>N1275</b>	230.0 x 30.0
-------	-----------	--------------	--------------	--------------	--------------

### Espace

With Bendix Rear Brakes	7/1985 - 10/96			<b>N1370</b>	228.6 x 40.0
With Lucas Rear Brakes	6/1991 - 12/96			<b>N3039</b>	228.6 x 42.0

### Florde

R1092	1960 - 62	<b>N1277</b>	230.0 x 35.0	<b>N1275</b>	230.0 x 30.0
-------	-----------	--------------	--------------	--------------	--------------

### Fuego

TL, GTL With Bendix Rear Brakes	3/1980 on			<b>N1467</b>	180.0 x 40.0
TL, GTL With Girling Rear Brakes	3/1980 on			<b>N1354</b>	228.6 x 40.0
GTX, TX, GTX With Bendix Rear Brakes	3/1980 on			<b>N1370</b>	228.6 x 40.0
GTX, TX, GTX With Girling Rear Brakes	3/1980 on			<b>N1416</b>	228.6 x 40.0

### Kangoo

With Heavy Duty Suspension	2004 on			<b>N3075</b>	228.6 x 42.0
With Standard Suspension	2004 on			<b>N3083</b>	203.2 x 36.5

### Megane

With Bendix Rear Brakes	1995 on			<b>N3040</b>	203.2 x 38.0
With Lucas Rear Brakes	10/1996 on			<b>N3039</b>	228.6 x 42.0

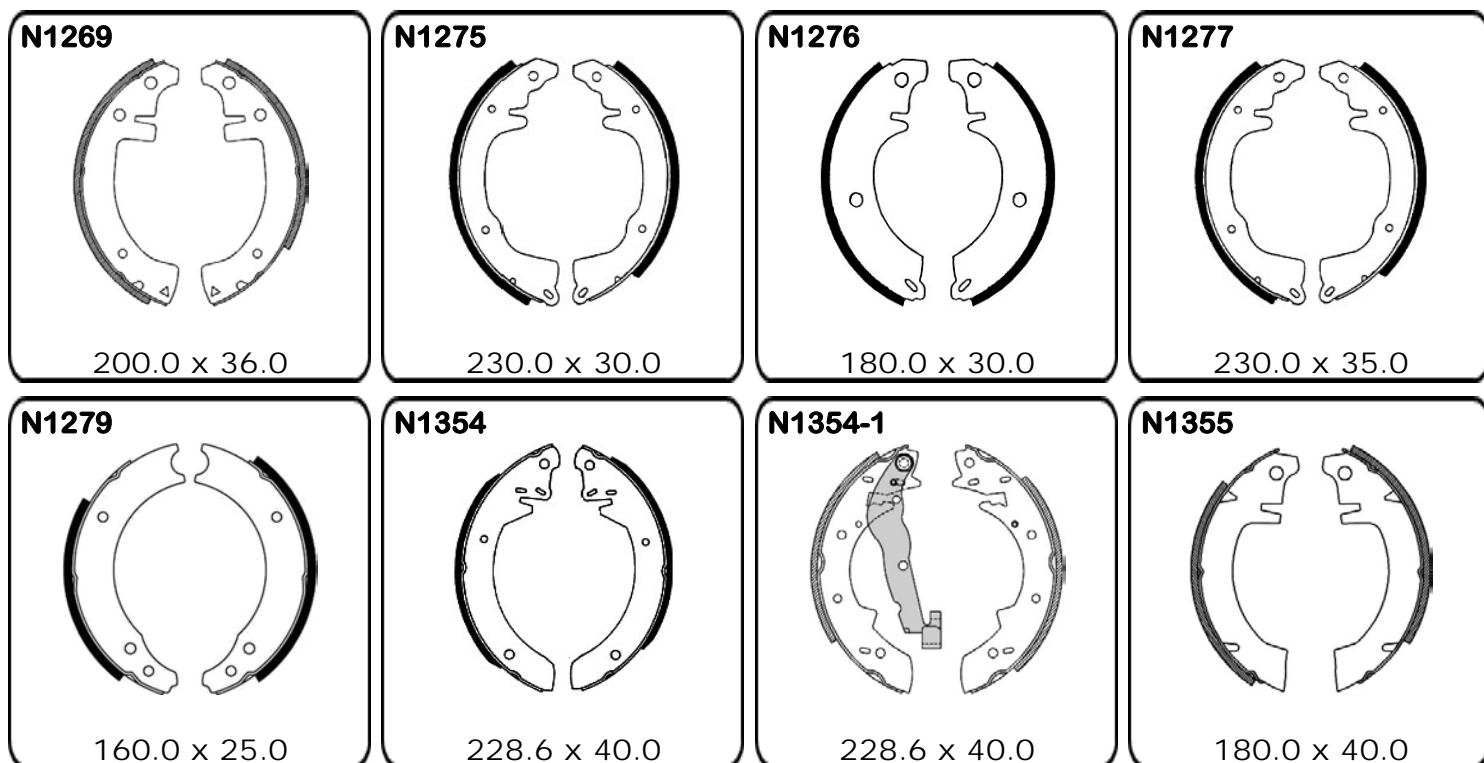



## RENAULT

**N1370**

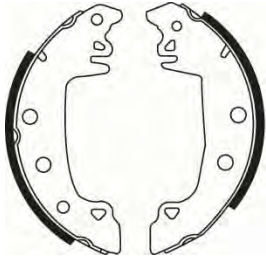

228.6 x 40.0

**N1416**

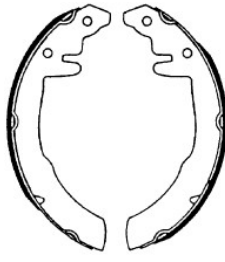

228.6 x 40.0

**N1455**

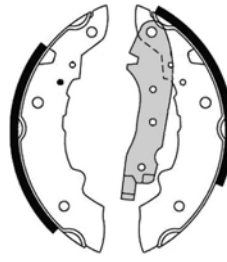

180.0 x 40.0

**N1467**

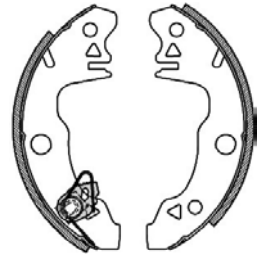

180.0 x 40.0

**N3018**

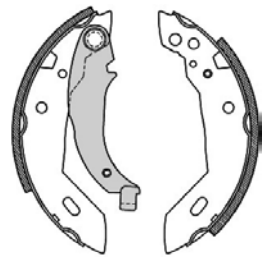

**N1803**

180.0 x 30.0

**N3032**

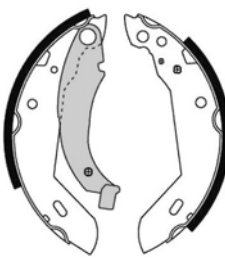

**N1728**

180.0 x 42.0

**N3037**

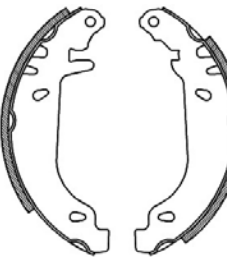

**N1811**

180.0 x 40.0

**N3038**



**N1812**

180.0 x 42.0

**N3039**

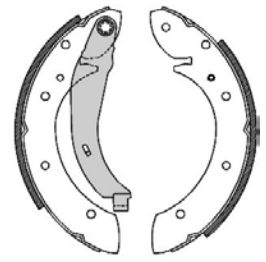

228.6 x 42.0

**N3040**

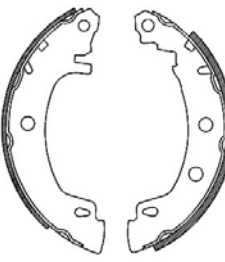

**N1814**

203.2 x 38.0

**N3041**

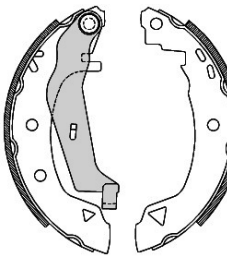

**N1815**

203.2 x 39.0

**N3075**

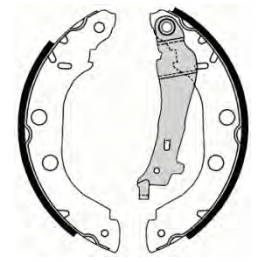

**N1842**

228.6 x 42.0

**N3083**

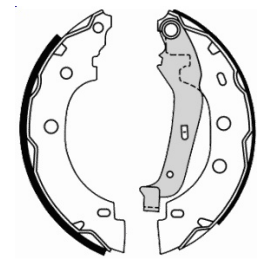

**N1840**

203.2 x 36.5



## ROVER

### 2000

2000	1982 - 7/87		<b>N1451</b>	228.6 x 57.1
------	-------------	--	--------------	--------------

### 2300

2300	1976 - 7/87		<b>N1451</b>	228.6 x 57.1
------	-------------	--	--------------	--------------

### 2400

2400D	1984 - 7/87		<b>N1451</b>	228.6 x 57.1
-------	-------------	--	--------------	--------------

### 2600

2600	1976 - 7/87		<b>N1451</b>	228.6 x 57.1
------	-------------	--	--------------	--------------

### 3500

500 V8	1976 - 81		<b>N1451</b>	228.6 x 57.1
--------	-----------	--	--------------	--------------

SE & SDI	1982 - 7/87		<b>N1451</b>	228.6 x 57.1
----------	-------------	--	--------------	--------------

### 416i

Hatch	1986 - 5/91		<b>N1611</b>	200.0 x 30.0
-------	-------------	--	--------------	--------------

### Quintet

Hatch 1.6L	1983 - 86		<b>N1393</b>	180.0 x 25.0
------------	-----------	--	--------------	--------------

### Vitesse

Vitesse	1984 on		<b>N1451</b>	228.6 x 57.1
---------	---------	--	--------------	--------------

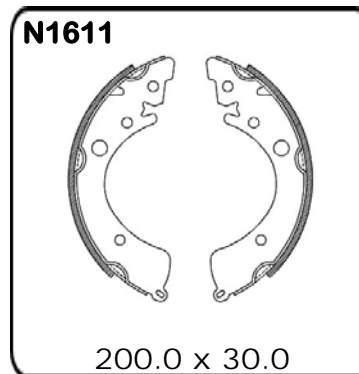
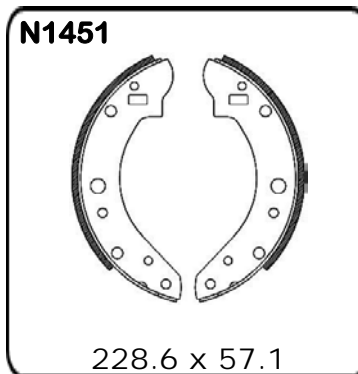
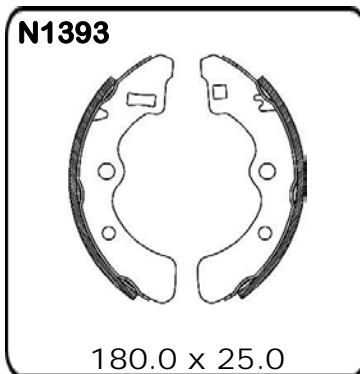

## SEAT

### Cordoba

1.8L	1995 on		<b>N3154</b>	200.0 x 40.0
------	---------	--	--------------	--------------

### Ibiza

1.4L	1995 on		<b>N3125</b>	180.0 x 31.0
------	---------	--	--------------	--------------



## SEAT

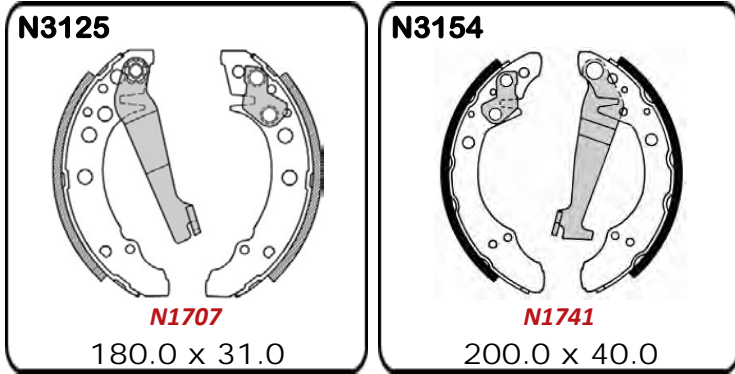

## SIMCA

### Aronde

Aronde	1958 - 65	<b>N1292</b>	255.0 x 45.0	<b>N1292</b>	255.0 x 45.0
--------	-----------	--------------	--------------	--------------	--------------

### Vedette

Vedette	1959 - 62	<b>N1293</b>	280.0 x 65.0	<b>N1295</b>	280.0 x 50.0
---------	-----------	--------------	--------------	--------------	--------------

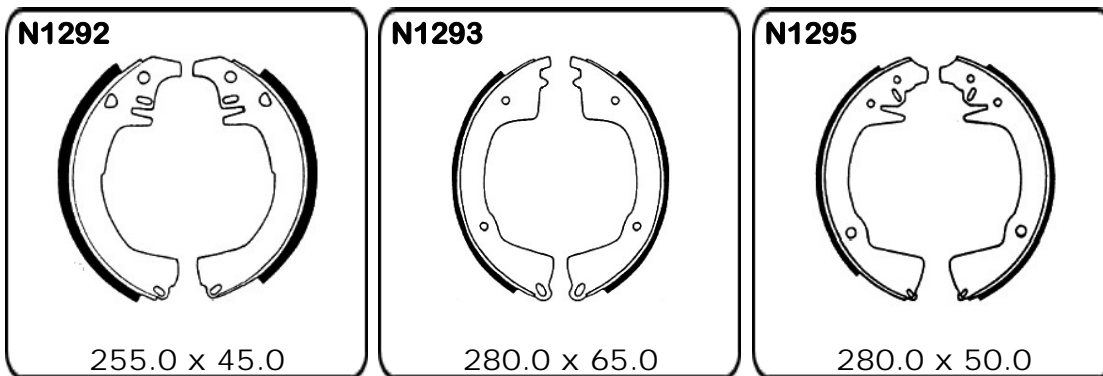

## SINGER

### Gazelle

All Models	1958 - 62	<b>N1298</b>	228.6 x 44.4	<b>N1298</b>	228.6 x 44.4
------------	-----------	--------------	--------------	--------------	--------------



## SINGER

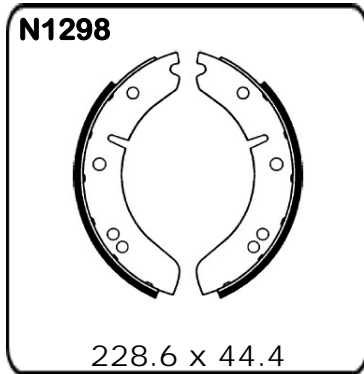

## SKODA

### MB100

MB100 SABRE	1965 - 69	<b>N1487</b>	230.0 x 40.0	<b>N1487</b>	230.0 x 40.0
-------------	-----------	--------------	--------------	--------------	--------------

### Octavia

All Models	1959 - 66	<b>N1488</b>	230.0 x 35.0	<b>N1489</b>	230.0 x 35.0
------------	-----------	--------------	--------------	--------------	--------------

### S100/S110

S100 & S110	1974 - 83			<b>N1487</b>	230.0 x 40.0
-------------	-----------	--	--	--------------	--------------

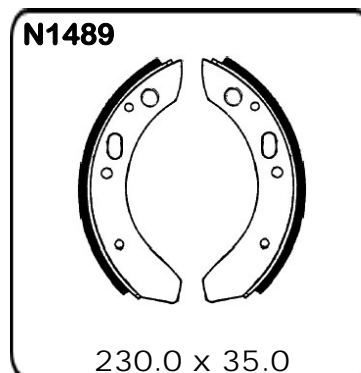
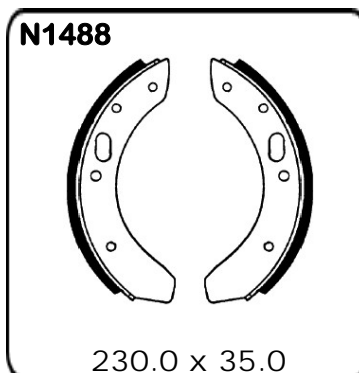
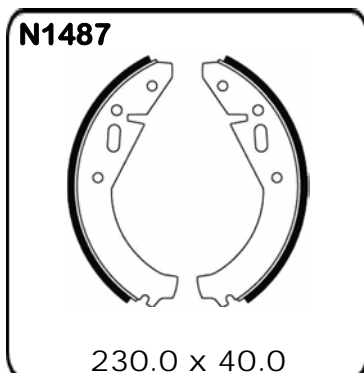





## SSANGYONG

### Musso

Banksia Park Brake Kit	10/1998 on	<b>Major</b>	PBK111	<b>Minor</b>	PBK110
------------------------	------------	--------------	--------	--------------	--------

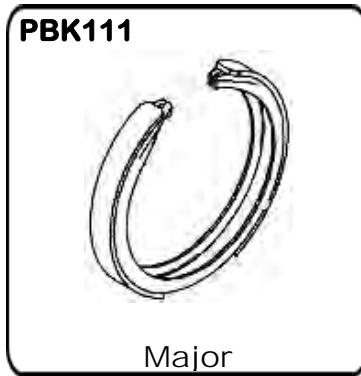
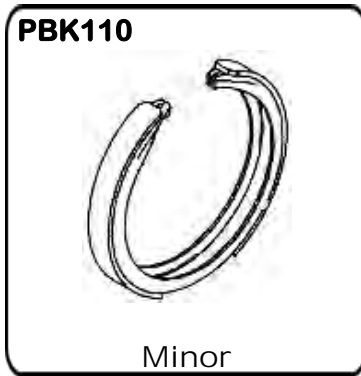

## STANDARD

### Atlas

500 & 600Kg	1958 - 63	<b>N1004</b>	228.6 x 44.4	<b>N1004</b>	228.6 x 44.4
-------------	-----------	--------------	--------------	--------------	--------------

### Cadet

10HP	1958 - 60	<b>N1137</b>	177.8 x 31.7	<b>N1143</b>	177.8 x 31.7
------	-----------	--------------	--------------	--------------	--------------

### Vanguard

4 Cyl to Chassis V326674	1957 - 58	<b>N1298</b>	228.6 x 44.4	<b>N1298</b>	228.6 x 44.4
4 Cyl from Chassis V326675 & 6 Cyl	1958 - 64	<b>N1285</b>	254.0 x 57.1	<b>N1285</b>	254.0 x 57.1

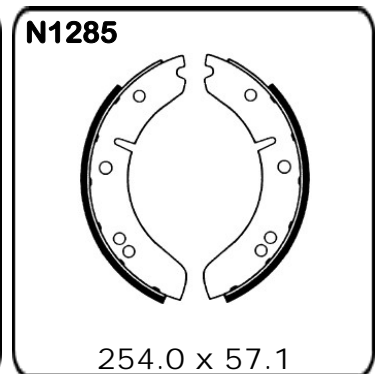
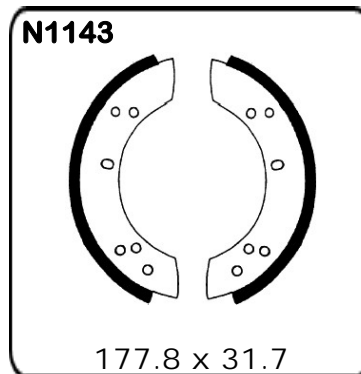
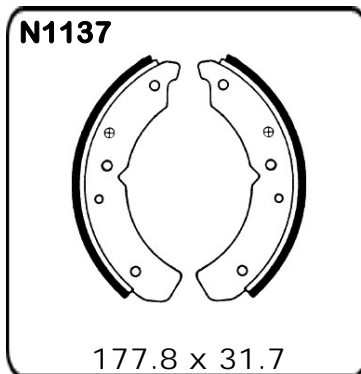
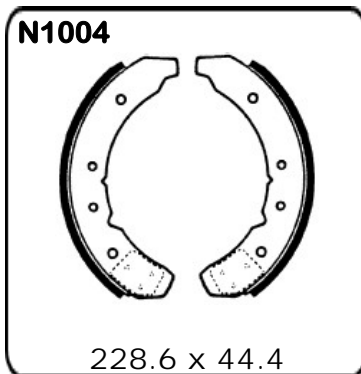



## STANDARD

---

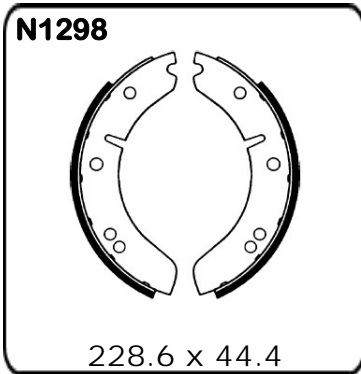

## STUDEBAKER

---

<b>Hawk</b>					
V8	1954 - 66	<b>N1183</b>	279.4 x 57.1	<b>N1184</b>	254.0 x 50.8
<b>Lark</b>					
V8	1954 - 66	<b>N1183</b>	279.4 x 57.1	<b>N1184</b>	254.0 x 50.8

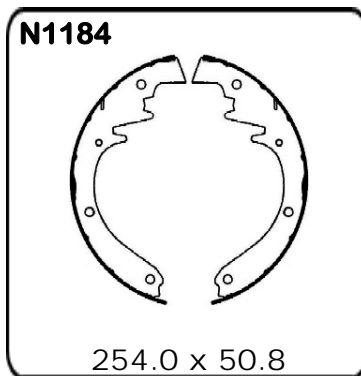
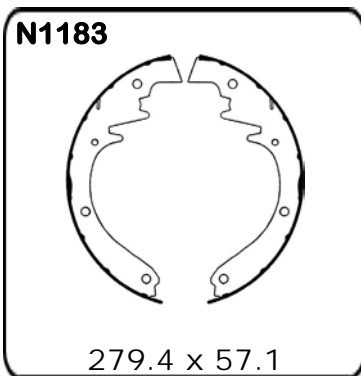

## SUBARU

---

<b>Brumby</b>					
Ute	1978 - 84			<b>N1368</b>	180.0 x 30.0



## SUBARU

### *Brumby*

Ute	1985 - 3/94			<b>N1649</b>	180.0 x 30.0
-----	-------------	--	--	--------------	--------------

### *DL*

1400, 1600 Drum/Drum	1973 - 76	<b>N1378</b>	228.6 x 44.8	<b>N1368</b>	180.0 x 30.0
1400, 1600 Disc/Drum	1975 - 78			<b>N1368</b>	180.0 x 30.0

### *FF-1*

A14	1970 - 71	<b>N1534</b>	203.2 x 45.0	<b>N1535</b>	180.0 x 35.0
A43	1970 - 71	<b>N1536</b>	228.6 x 40.0	<b>N1537</b>	180.0 x 30.0
A14Z	1970 - 71			<b>N1535</b>	180.0 x 35.0

### *Fiori*

FWD	1990 - 93			<b>N1666</b>	180.0 x 25.0
-----	-----------	--	--	--------------	--------------

### *Forester*

Wagon	98 on			<b>N3143</b>	228.6 x 35.0
-------	-------	--	--	--------------	--------------

### *Impreza*

GC, FG, 1.5, 1.8L	11/1993 on			<b>N3143</b>	228.6 x 35.0
GC, GF, 1.5, 1.8L	1993 - 11/93			<b>N3142</b>	203.2 x 35.0
Excl Sti	2002 - 07			<b>N3227</b>	170.0 x 30.0

### *Leone*

Sedan AB4, AB5, AF5 1800 DL	1979 - 84			<b>N1368</b>	180.0 x 30.0
2WD	1985 on			<b>N1667</b>	180.0 x 30.0
4WD	1985 on			<b>N1649</b>	180.0 x 30.0

### *Liberty/Legacy*

TI	1990 - 93			<b>N3142</b>	203.2 x 35.0
DL, GL	1990 - 93			<b>N3143</b>	228.6 x 35.0
BD & BG	1/1994 on			<b>N3143</b>	228.6 x 35.0
GT & L Models	00 on		<b>Handbrake</b>	<b>N3050</b>	170.0 x 35.0

### *Outback*

MY03 Handbrake Shoes	2000 - 03		<b>Handbrake</b>	<b>N3050</b>	170.0 x 35.0
MY03 Handbrake Shoes	2003 - 07		<b>Handbrake</b>	<b>N3227</b>	170.0 x 30.0

### *Sherpa*

400Kg Van 2 Cyl	1978 - 83			<b>N1368</b>	180.0 x 30.0
KM3 Van	1982 - 83			<b>N1618</b>	170.0 x 30.0



## SUBARU

**N1368**

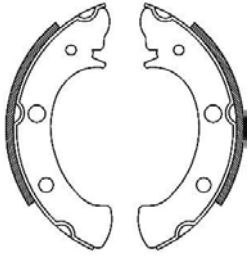

180.0 x 30.0

**N1378**

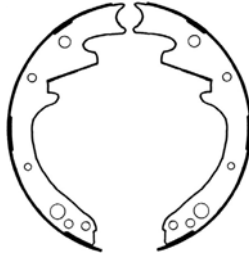

228.6 x 44.8

**N1534**

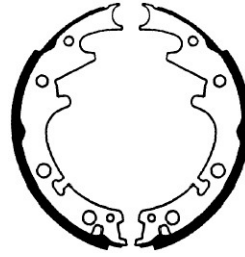

203.2 x 45.0

**N1535**

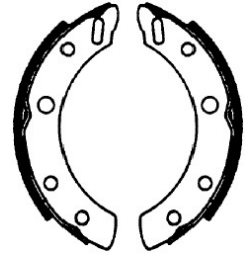

180.0 x 35.0

**N1536**

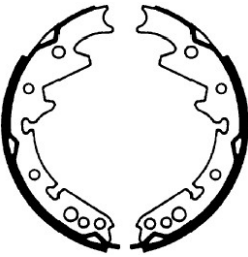

228.6 x 40.0

**N1537**

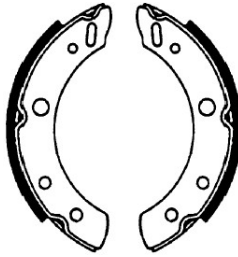

180.0 x 30.0

**N1618**



170.0 x 30.0

**N1649**

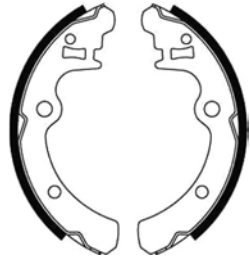

180.0 x 30.0

**N1666**

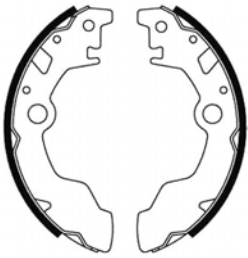

180.0 x 25.0

**N1667**

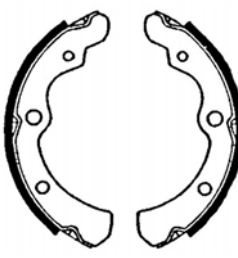

180.0 x 30.0

**N3050**

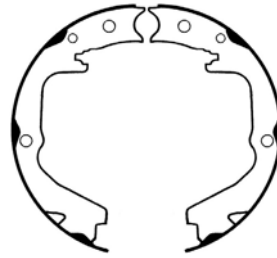

**N1857**  
170.0 x 35.0

**N3142**

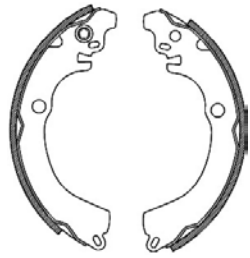

**N1729**  
203.2 x 35.0

**N3143**

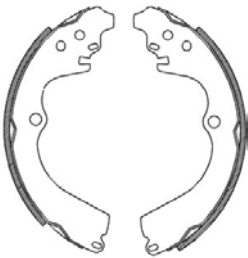

**N1730**  
228.6 x 35.0

**N3227**

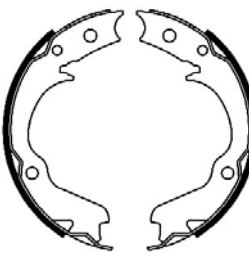

**N1846**  
170.0 x 30.0



## SUZUKI

### *Alto/Hatch*

Van	1980 - 85	<b>N1564</b>	180.0 x 35.0	<b>N1565</b>	180.0 x 35.0
CA91V, CA91S, CB91S, CA, GL	1981 - 99			<b>N1676</b>	180.0 x 30.0
Alto SS80	1981 on			<b>N1565</b>	180.0 x 35.0
Alto SS40	1982 - 84	<b>N1633</b>	180.0 x 34.0	<b>N1565</b>	180.0 x 35.0

### *APV*

1.6L	2006 on			<b>N3092</b>	220.0 x 41.5
------	---------	--	--	--------------	--------------

### *Baleno*

1.6L Sedan & Hatch	4/1995 on			<b>N3101</b>	200.0 x 30.0
--------------------	-----------	--	--	--------------	--------------

### *Carry*

ST10, ST20 Van	1967 - 78	<b>N1410</b>	180.0 x 29.0	<b>N1410</b>	180.0 x 29.0
ST80 Van	1978 - 79	<b>N1367</b>	210.0 x 35.0	<b>N1367</b>	210.0 x 35.0
ST90 550Kg Van	1980 - 82	<b>N1538</b>	180.0 x 35.0	<b>N1538</b>	180.0 x 35.0
ST90 600Kg Van	1980 - 82	<b>N1539</b>	220.0 x 39.0	<b>N1539</b>	220.0 x 39.0
ST90 Super Carry Van	1986 on			<b>N1624</b>	220.0 x 39.0
GA413	2000			<b>N3174</b>	228.6 x 35.0

### *Cino*

1.3L 3 & 5 Door	5/1994 on			<b>N3103</b>	180.0 x 25.0
-----------------	-----------	--	--	--------------	--------------

### *Grand Vitara*

SQ625 2.5L	1999 - 06			<b>N3195</b>	220.0 x 40.0
JA627 2.7L V6 XL-7	01 - 05			<b>N3071</b>	254.0 x 54.5
4Cyl & V6	2006 on			<b>N3060</b>	254.0 x 40.0

### *Ignis*

RG415 1.3L	2000 - 03			<b>N3021</b>	180.0 x 25.0
------------	-----------	--	--	--------------	--------------

### *Jimny*

1.3L	1998 on			<b>N3174</b>	228.6 x 35.0
------	---------	--	--	--------------	--------------

### *Liana*

1.6 & 1.8L	2001 on			<b>N3101</b>	200.0 x 30.0
------------	---------	--	--	--------------	--------------

### *LJ Series*

LJ50	1974 - 77	<b>N1367</b>	210.0 x 35.0	<b>N1367</b>	210.0 x 35.0
LJ80	1978 - 81	<b>N1599</b>	210.0 x 35.0	<b>N1599</b>	210.0 x 35.0
LJ80 Handbrake	1978 - 81		<b>Handbrake</b>	<b>N3153</b>	180.0 x 29.0

### *Mighty Boy*

3 Cyl Ute	1985 on			<b>N1616</b>	180.0 x 30.0
-----------	---------	--	--	--------------	--------------

### *Samurai*

All Models	1987 on			<b>N1617</b>	220.0 x 39.0
------------	---------	--	--	--------------	--------------

### *Sierra*

SJ410 1.0L, SJ413 1.3L Some	1981 on			<b>N1628</b>	220.0 x 39.0
-----------------------------	---------	--	--	--------------	--------------





## SUZUKI

### Sierra

SJ410 1.0L, SJ413 1.3L Most	1981 on			<b>N1627</b>	220.0 x 39.0
All Models With Drum/Drum	1981 on	<b>N1539</b>	220.0 x 39.0	<b>N1539</b>	220.0 x 39.0
Handbrake	1988 on		<b>Handbrake</b>	<b>N3153</b>	180.0 x 29.0
All Models	1988 on			<b>N1617</b>	220.0 x 39.0

### Swift

SA310	1986 - 89			<b>N1616</b>	180.0 x 30.0
SF310, SF413 GL, GS, GLX 2WD 3 & 5 Door	1990 on			<b>N3103</b>	180.0 x 25.0
SF413 2WD 2 Door, 4WD & SF416	1990 on			<b>N3101</b>	200.0 x 30.0
RS415 1.3L & 1.5L	2004 on			<b>N3089</b>	200.0 x 32.0

### Vitara

All Models 1.6L	1989 - 92			<b>N3110</b>	220.0 x 34.0
1.6L	1993 on			<b>N3102</b>	220.0 x 34.0
TA11W	1993 on			<b>N3168</b>	254.0 x 45.0
SV620 2.0L V6	12/95 on			<b>N3148</b>	254.0 x 45.0

### Wagon R+

1.0L Wagon	1997 on			<b>N3045</b>	180.0 x 25.0
------------	---------	--	--	--------------	--------------

### X-90

1.6L	1996 on			<b>N3155</b>	220.0 x 34.0
------	---------	--	--	--------------	--------------

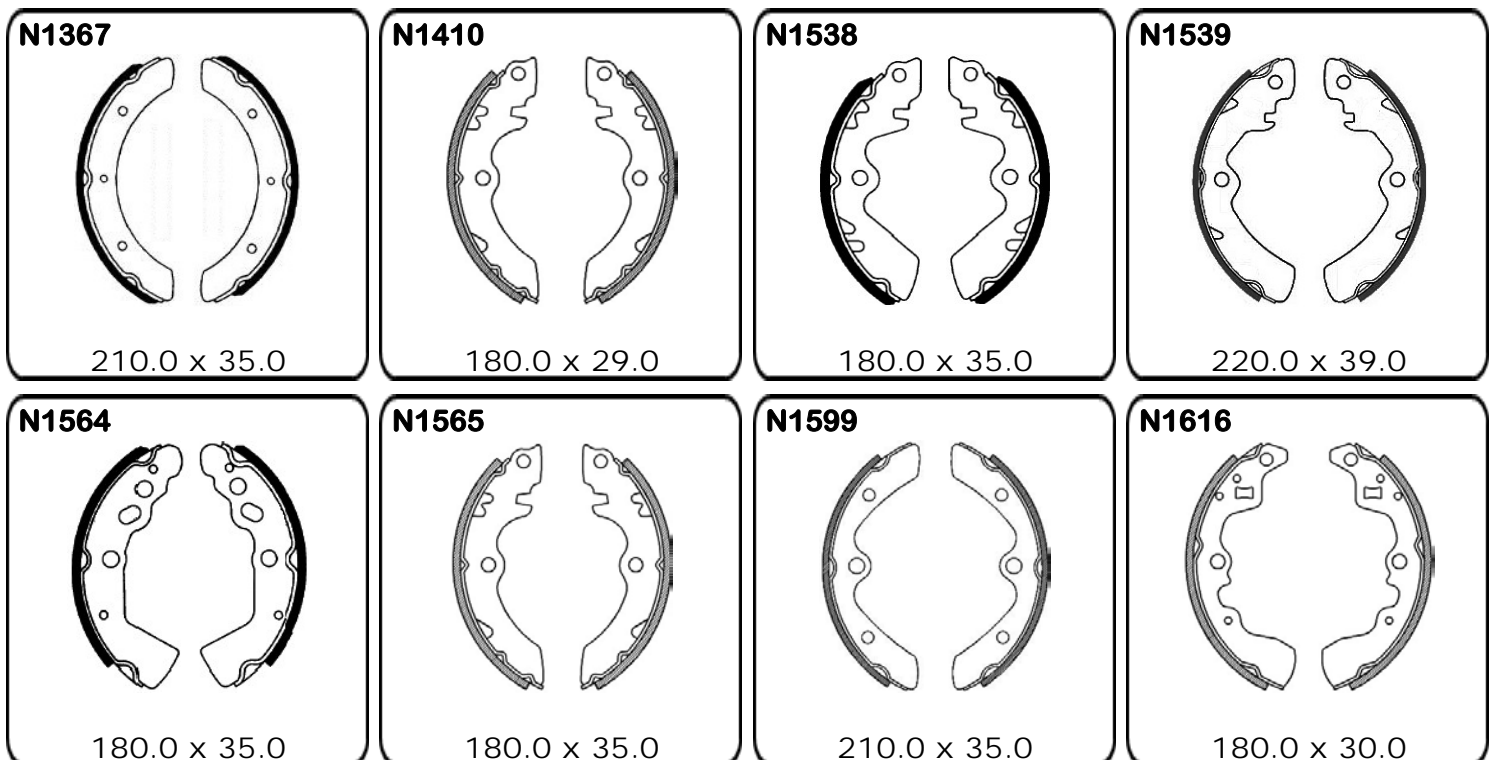



## SUZUKI

**N1617**

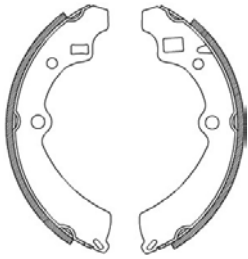

220.0 x 39.0

**N1624**

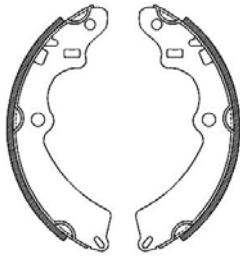

220.0 x 39.0

**N1627**

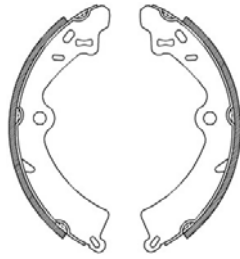

220.0 x 39.0

**N1628**

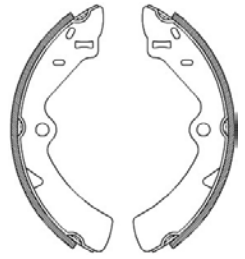

220.0 x 39.0

**N1633**

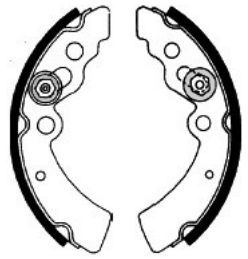

180.0 x 34.0

**N1676**



180.0 x 30.0

**N3021**

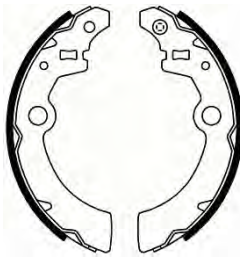

180.0 x 25.0

**N1820**

**N3045**

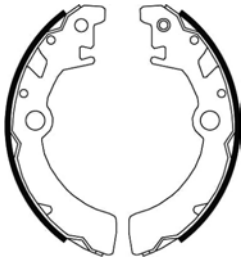

180.0 x 25.0

**N1828**

**N3060**

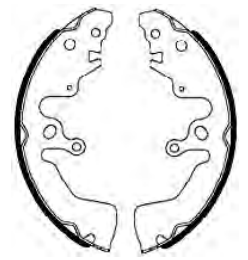

254.0 x 40.0

**N1861**

**N3071**

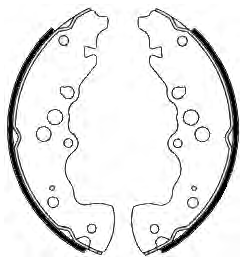

254.0 x 54.5

**N1869**

**N3089**

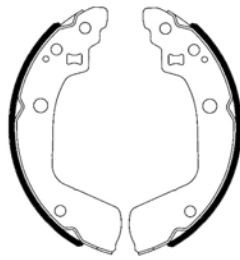

200.0 x 32.0

**N1871**

**N3092**

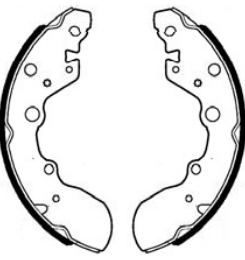

220.0 x 41.5

**N1884**

**N3101**

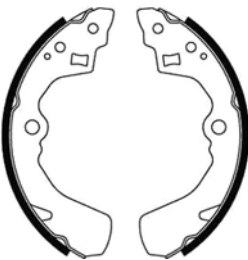

200.0 x 30.0

**N1682**

**N3102**

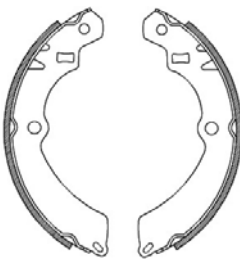

220.0 x 34.0

**N1683**

**N3103**

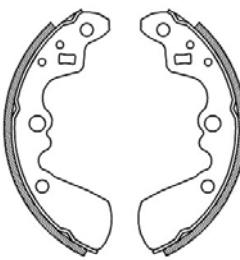

180.0 x 25.0

**N1684**

**N3110**

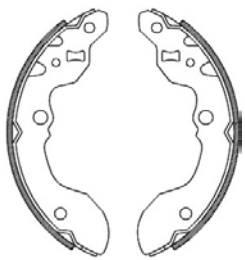

220.0 x 34.0

**N1691**



## SUZUKI

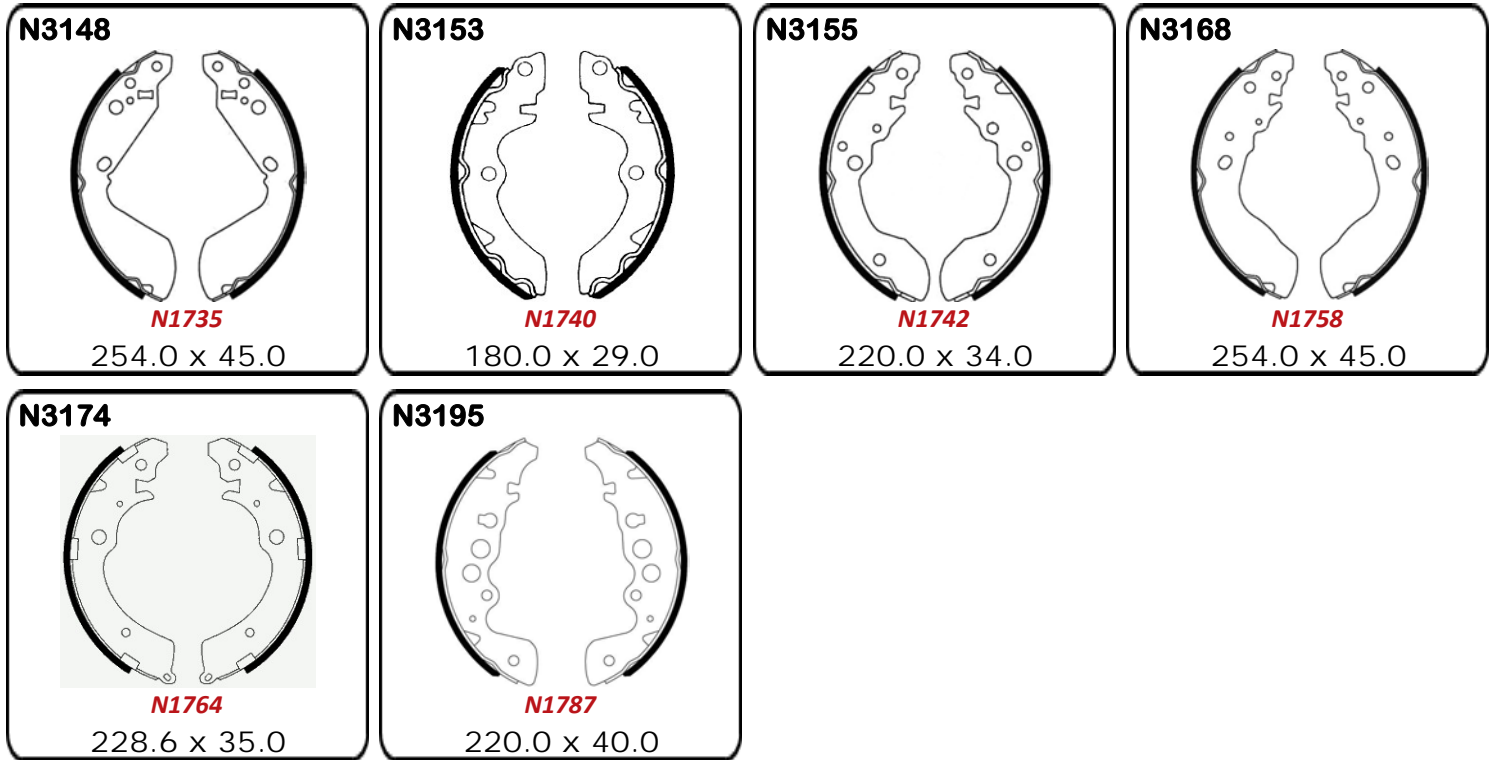

## TOYOTA

<b>Avalon</b>					
MCX10	4/00 - 9/03		Handbrake	N3162	170.0 x 30.0
<b>Avensis Verso</b>					
ACM21	10/03 on		Handbrake	N3199	190.0 x 25.0
<b>Blizzard</b>					
LD10	1982 - 83			N1407	254.0 x 45.0
<b>Bundera</b>					
RJ70, RJ75	1985 - 5/93			N1492	254.0 x 50.0
RJ70, RJ75	5/1993 on			N1660	295.0 x 50.0
<b>Camry</b>					
SV11	1983 - 87			N1490	200.0 x 35.0
SV20, SV21, SV22	1987 - 93			N1659	228.6 x 40.0
SDV10 2.2L	3/1993 - 97			N1659	228.6 x 40.0



## TOYOTA

### Camry

Disc/Disc Models Handbrake	8/1997 on		Handbrake	N3162	170.0 x 30.0
ACV36 & MCV36 Banksia Park Brake	9/2002 - 6/03	Major	PBK227	Minor	PBK174
ACV36, MCV36	8/02 - 8/04		Handbrake	N3162	170.0 x 30.0

### Celica

TA22, RA23, RA28, RA40, RA60, RA63	1971 - 84			N1358	228.6 x 40.0
RA65	1984 - 85			N1646	228.6 x 40.0
ST204, ST205	11/93 - 8/99		Handbrake	N3162	170.0 x 30.0

### Coaster

RU18, R719	2/1969 - 6/77	N1496	320.0 x 65.0	N1497	320.0 x 85.0
RU18, R719 Handbrake	2/1969 - 6/77		Handbrake	N1540	160.0 x 35.0
RB11, RB13, BB10	8/1977 - 5/82	N1448	320.0 x 65.0	N1449	320.0 x 87.0
RB11, RB13, BB10 Handbrake	8/1977 - 5/82		Handbrake	N1542	160.0 x 35.0
RB20, BB20 Drum/Drum	5/1982 - 8/84	N3119	320.0 x 75.0	N1449	320.0 x 87.0
RB20, BB20 Disc/Drum	5/1982 - 8/84			N1449	320.0 x 87.0
RB20, BB20 Handbrake	5/1982 - 8/84		Handbrake	N1542	160.0 x 35.0
BB30	6/1983 - 8/84			N1449	320.0 x 87.0
BB30 Handbrake	6/1983 - 8/84		Handbrake	N1543	178.0 x 35.0
RB20, BB20	8/1984 on	N1635	320.0 x 75.0	N1631	320.0 x 75.0
BB30 Handbrake	8/1984 on		Handbrake	N1543	178.0 x 35.0
HZB30 Disc/Drum	8/84 - 1/93			N1631	320.0 x 75.0
BB30	8/1984 on			N1631	320.0 x 75.0
RB20, BB20 Disc/Drum	8/1984 on			N1631	320.0 x 75.0
RB20, BB20 Handbrake	8/1984 on		Handbrake	N1542	160.0 x 35.0
BB40, 42, 50, HZB50, RZB40, 50 Drum/Drum	1/1993 on	N3159	320.0 x 83.0	N3159	320.0 x 83.0
BB40, HZB40, HZB50	1/19 6/99			N3159	320.0 x 83.0
BB40, HZB40, HZB50 Handbrake	1/1993 on		Handbrake	N3156	200.0 x 45.0
HZB50	7/99 - 11/02			N3063	320.0 x 83.0
XZB50	8/2004 on			N3063	320.0 x 83.0

### Corolla

KE10, KE16 Sedan & Wagon	1967 - 69	N1065	200.0 x 35.0	N1066	200.0 x 30.0
KE11, KE18 Sedan & Wagon	1970 - 71	N1065	200.0 x 35.0	N1066	200.0 x 30.0
KE20 Sedan	1971 - 73	N1190	200.0 x 40.0	N1189	200.0 x 35.0
KE20 Sedan With PBR Rear Brakes	1971 - 72			N1179	200.0 x 35.0
KE25, DE35 Coupe	1971 - 76			N1189	200.0 x 35.0
KE26 Wagon	1973 - 74	N1190	200.0 x 40.0	N1189	200.0 x 35.0
KE30 Sedan With Imported Brakes	1974 - 78			N1189	200.0 x 35.0
KE30 Sedan, KE35 Coupe	1974 - 78			N1356	228.6 x 38.1
KE36, KE38 Wagon	1974 - 82			N1189	200.0 x 35.0
KE50 Liftback With Imported Brakes	1977 - 78			N1189	200.0 x 35.0



## TOYOTA

### Corolla

KE38 Wagon With PBR Rear Brakes	8/78 - 82			<b>N1356</b>	228.6 x 38.1
KE55 Sedan & Coupe With PBR Rear Brakes	1978 - 81			<b>N1356</b>	228.6 x 38.1
KE55 Liftback With Imported Brakes	11/78 - 80			<b>N1189</b>	200.0 x 35.0
KE70 KE71 Sedan With PBR Brakes	9/81 - 95			<b>N1179</b>	200.0 x 35.0
KE70 KE71 Wagon With PBR Brakes	9/81 - 95			<b>N1356</b>	228.6 x 38.1
AE71 All Models	1983 - 85			<b>N1189</b>	200.0 x 35.0
AE86 Sprinter Coupe	1983 - 84			<b>N1358</b>	228.6 x 40.0
AE80, AE82, AE90, AE92, AE93, AE94 FWD	1985 - 8/94			<b>N1602</b>	200.0 x 30.0
AE95 4WD	1987 on			<b>N1189</b>	200.0 x 35.0
AE101, AE102	9/1994 on			<b>N3123</b>	200.0 x 30.0
AE111, AE112R	1998 - 01			<b>N1490</b>	200.0 x 35.0

### Corona

RT40 Sedan To Chassis CH428074	1964 - 67	<b>N1072</b>	228.6 x 40.0	<b>N1072</b>	228.6 x 40.0
RT56 Fastback/Wagon & RT72 Hardtop	1966 - 68	<b>N1044</b>	228.6 x 40.0	<b>N1044</b>	228.6 x 40.0
RT40 Sedan From Chassis CH428075	1967 - 68	<b>N1044</b>	228.6 x 40.0	<b>N1044</b>	228.6 x 40.0
RT40 Sedan With Imported Brakes	1969 - 70	<b>N1054</b>	228.6 x 44.4	<b>N1182</b>	228.6 x 40.0
RT80, RT81 With PBR Brakes	1970 - 73	<b>N1182</b>	228.6 x 40.0	<b>N1062</b>	228.6 x 38.1
MKII MX13, MX22, MX23	1972 - 77			<b>N1376</b>	228.6 x 40.0
RT81 Disc/Drum	1973 - 74			<b>N1062</b>	228.6 x 38.1
RT104, RT118, RT132, RT133, XT130, XT131	1974 - 87			<b>N1358</b>	228.6 x 40.0
XT130, XT131 With Girlock Front Brakes	1979 - 83			<b>N1356</b>	228.6 x 38.1
ST170, ST190	1987 on			<b>N1490</b>	200.0 x 35.0

### Cressida

MX32, MX36, MX62, MX73	1977 - 84			<b>N1358</b>	228.6 x 40.0
MX73, MX83 Disc/Disc Models - Some	1988 - 96		<b>Handbrake</b>	<b>N3042</b>	170.0 x 30.0
MX73, MX83 Disc/Disc Models - Some	1988 - 96		<b>Handbrake</b>	<b>N3082</b>	175.0 x 30.0

### Crown

RS40, RS41, RS46, MS41 4 Cyl	1964 - 68	<b>N1070</b>	230.0 x 50.0	<b>N1070</b>	230.0 x 50.0
MS41 6 Cyl	1966 - 67			<b>N1070</b>	230.0 x 50.0
MS45, MS46, MS47 6 Cyl	1967			<b>N1070</b>	230.0 x 50.0
MS55 With Imported Brakes	1967 - 71			<b>N1034</b>	230.0 x 55.0
MS57 Wagon Drum/Drum	1967 - 71	<b>N1033</b>	230.0 x 55.0	<b>N1034</b>	230.0 x 55.0
MS57 Wagon Disc/Drum	1967 - 71			<b>N1034</b>	230.0 x 55.0
MS53 6 Cyl	1968 - 71			<b>N1034</b>	230.0 x 55.0
MS55 Drum/Drum	1968 - 71	<b>N1033</b>	230.0 x 55.0	<b>N1034</b>	230.0 x 55.0
RS50, RS56 4 Cyl	1968 - 70	<b>N1033</b>	230.0 x 55.0	<b>N1034</b>	230.0 x 55.0
MS55, MS65 With PBR Brakes	1970 - 75			<b>N1062</b>	228.6 x 38.1
MS83, MS85	1975 - 78			<b>N1396</b>	254.0 x 50.8
MS85, MS111	1978 - 80			<b>N1396</b>	254.0 x 50.8





## TOYOTA

### Dyna

Dyna 150 RK170, 171 2000KG Cab Chassis	1962 - 69			<b>N1083</b>	290.0 x 55.0
RU10, RU15 With SRW	1969 - 6/77	<b>N1496</b>	320.0 x 65.0	<b>N1496</b>	320.0 x 65.0
RU10, RU12, RU15, HU15 With DRW	1969 - 6/77	<b>N1496</b>	320.0 x 65.0	<b>N1497</b>	320.0 x 85.0
RU12, BU20, RU20, JU20 With SRW	1976 - 84	<b>N1454</b>	295.0 x 75.0	<b>N1454</b>	295.0 x 75.0
RU20, 25, 30, 32 3000KG Cab Chassis With DRW	8/1977 - 8/84	<b>N1448</b>	320.0 x 65.0	<b>N1499</b>	228.6 x 44.4
BU40, HU40, HU50, WU40 With DRW	8/1977 - 8/84	<b>N1623</b>	320.0 x 90.0	<b>N1623</b>	320.0 x 90.0
BU20, BU30 Low Tray With DRW	1980 - 84	<b>N1454</b>	295.0 x 75.0	<b>N1622</b>	224.0 x 57.0
WU90, WU95 With DRW	9/1984 on	<b>N1623</b>	320.0 x 90.0	<b>N1623</b>	320.0 x 90.0
BU60, BU80, BU96 With DRW	9/1984 - 9/91	<b>N1629</b>	295.0 x 75.0	<b>N1645</b>	260.0 x 85.0
DYNA 200 YU60, BU60, BU61, BU70 With SRW	1984 on	<b>N1629</b>	295.0 x 75.0	<b>N1629</b>	295.0 x 75.0
BU60, BU61, BU75, RU75, YU60 With DRW	9/1984 on			<b>N1631</b>	320.0 x 75.0
YU60, 61, 80, RU75, 85, BU60, 62, 63, 66, 75, 76	9/1984 - 9/91	<b>N1635</b>	320.0 x 75.0	<b>N1631</b>	320.0 x 75.0
Dyna 100 LH80, YH81	8/1987 on			<b>N1405</b>	254.0 x 55.0
Dyna 150 LY60R, 61R	8/1987 on			<b>N1622</b>	224.0 x 57.0
WU90, 95 Handbrake	1987 - 88		<b>Handbrake</b>	<b>N3156</b>	200.0 x 45.0
BU91, 96	8/88 - 5/95	<b>N1623</b>	320.0 x 90.0	<b>N1623</b>	320.0 x 90.0
BU91, 96 Handbrake	1988 - 91		<b>Handbrake</b>	<b>N3156</b>	200.0 x 45.0
BU61 Handbrake	1988 - 98		<b>Handbrake</b>	<b>N1542</b>	160.0 x 35.0
BU60, 65 - Handbrake	1988 - 95		<b>Handbrake</b>	<b>N1542</b>	160.0 x 35.0
YU62 - Handbrake	1988 - 97		<b>Handbrake</b>	<b>N1542</b>	160.0 x 35.0
80, 81, 82, 85, 88 With DRW	9/1991 on	<b>N3112</b>	320.0 x 75.0	<b>N1631</b>	320.0 x 75.0
BU60, BU80, BU96 With DRW	9/1991 on	<b>N3112</b>	320.0 x 75.0	<b>N1645</b>	260.0 x 85.0
With 178mm Drum Handbrake			<b>Handbrake</b>	<b>N1543</b>	178.0 x 35.0
BU20 Only Handbrake			<b>Handbrake</b>	<b>N1540</b>	160.0 x 35.0
LY220, 230	7/01 - 12/04			<b>N3065</b>	260.0 x 85.0
BU300, 340 5.5t	12/02 - 12/03			<b>N3159</b>	320.0 x 83.0
XZU404	12/02 on			<b>N3159</b>	320.0 x 83.0

### Echo

NCP10 1.3 Sedan & Hatch	3/1999 on			<b>N3182</b>	180.0 x 25.0
-------------------------	-----------	--	--	--------------	--------------

### Hiace

RH10, RH11, RH15, RH16	1967 - 8/73	<b>N1025</b>	230.0 x 50.0	<b>N1028</b>	230.0 x 50.0
RH11, RH16	9/1973 - 10/75	<b>N1493</b>	230.0 x 50.0	<b>N1028</b>	230.0 x 50.0
RH11, 16, 20, 22, 32, 42. LH20, 30	11/1975 - 82	<b>N1388</b>	254.0 x 50.0	<b>N1371</b>	254.0 x 55.5
RH11, 20, 22, 32, LH42, 20, 30	1982 - 83			<b>N1405</b>	254.0 x 55.0
YH50, 51, 53, 61, 71, 73, LH50, 51, 60, 61, 70, 71	1983 - 89			<b>N1405</b>	254.0 x 55.0
YH53, YH63, YH73	8/1987 - 10/89			<b>N1492</b>	254.0 x 50.0
LH102, 103, 104, 105, 112, 113, 115, 125	9/1989 - 8/93			<b>N1678</b>	270.0 x 55.0
RZH102, 103, 104, 105, 112, 113, 114, 115, 125	9/1989 - 8/93			<b>N1678</b>	270.0 x 55.0
LH108, LH118, RZH109, RZH119	9/1989 on			<b>N1660</b>	295.0 x 50.0



## TOYOTA

### Hiace

LH102, 103, 104, 105, 112, 113, 115, 125, LH162	9/1993 on			<b>N3132</b>	270.0 x 55.0
RZH102, 103, 104, 105, 112, 113, 114, 115, 125	9/1993 on			<b>N3132</b>	270.0 x 55.0
RCH12, RCH22	7/99 - 11/03			<b>N3132</b>	270.0 x 55.0
LH112, 172, 174, 184, RZH114, 125	7/99 - 1/05			<b>N3132</b>	270.0 x 55.0
KDH, TRH Series	1/2005 on			<b>N3064</b>	254.0 x 50.0

### Hilux/4 Runner

RN10, RN13, RN15, RN16	1968 - 72	<b>N1025</b>	230.0 x 50.0	<b>N1028</b>	230.0 x 50.0
RN20, RN25, RN27	1972 - 78	<b>N1375</b>	254.0 x 55.5	<b>N1371</b>	254.0 x 55.5
RN30, RN31, RN40, RN41, LN40	8/78 - 8/83	<b>N1388</b>	254.0 x 50.0	<b>N1371</b>	254.0 x 55.5
LN46, RN36, RN46 4WD	1979 - 7/83			<b>N1405</b>	254.0 x 55.0
RN41	1979 - 83			<b>N1492</b>	254.0 x 50.0
YN55, YN57, LN55, LN56	1983 - 8/86			<b>N1405</b>	254.0 x 55.0
YN57, YN58, SR5	1983 - 88			<b>N1492</b>	254.0 x 50.0
YN60, YN65, YN67, LN60, LN65	8/83 - 1988			<b>N1405</b>	254.0 x 55.0
YN63, LN61	8/83 - 8/85			<b>N1405</b>	254.0 x 55.0
YN63, LN61	8/85 - 8/86			<b>N1647</b>	295.0 x 50.0
YN55, YN57, LN55, LN56	8/1986 - 1987			<b>N1660</b>	295.0 x 50.0
YN63, LN61	8/86 - 8/88			<b>N1660</b>	295.0 x 50.0
YN85	8/1988 - 8/91			<b>N1660</b>	295.0 x 50.0
RN85, 105, 110, 130, LN85, 86, 106, 107, 111	8/1988 - 8/93			<b>N1405</b>	254.0 x 55.0
RN90	8/1988 on			<b>N1492</b>	254.0 x 50.0
LN130, VZN130	8/1989 on			<b>N1660</b>	295.0 x 50.0
VZN130 V6 4 Runner	1993 - 96			<b>N1660</b>	295.0 x 50.0
YN87 2WD	1997 on			<b>N1660</b>	295.0 x 50.0
KZN165, RZN167, 168, 169, 174, 193	8/97 - 2/05			<b>N1660</b>	295.0 x 50.0
LN141, 146, 152, RZN144, 145, 147, 152	8/1997 on			<b>N3132</b>	270.0 x 55.0
LN145, 147, RZN142, 147, 149, 154	8/97 - 5/98			<b>N3132</b>	270.0 x 55.0
LN166, 167, 171, 172, 191	8/1997 on			<b>N1660</b>	295.0 x 50.0
LN147, RZN149, RZN154	5/98 - 2/05			<b>N3178</b>	254.0 x 50.0
VZN165, 172	8/01 - 2/05			<b>N1660</b>	295.0 x 50.0
Hilux GGN ,KUN & TGN Series 4WD	2005 on			<b>N3056</b>	295.0 x 61.4
Hilux GGN ,KUN & TGN Series 2WD	2005 on			<b>N3088</b>	254.0 x 50.0

### Landcruiser

FJ40, FJ45, FJ55 Handbrake	1961 - 73		<b>Handbrake</b>	<b>N1541</b>	160.0 x 35.0
FJ40, FJ45, FJ55	1963 - 70	<b>N1083</b>	290.0 x 55.0	<b>N1083</b>	290.0 x 55.0
FJ40, FJ45, FJ55	1971 - 80	<b>N1415</b>	295.0 x 75.0	<b>N1415</b>	295.0 x 75.0
All Models With Transmission Brake Handbrake	1973 on		<b>Handbrake</b>	<b>N1540</b>	160.0 x 35.0
BJ40, 42, J43, 46, FJ40, 43, 60, FJ60, HJ60, 62	1980 - 1/90	<b>N1415</b>	295.0 x 75.0	<b>N1414</b>	295.0 x 60.0
Drum/Drum	1980 - 1/90			<b>N1414</b>	295.0 x 60.0



## TOYOTA

### Landcruiser

FJ45, HJ47	1/1982 - 6/85	<b>N1415</b>	295.0 x 75.0	<b>N1414</b>	295.0 x 60.0
BJ70, 75, FJ73, 75, 75 Drum/Drum	11/1984 - 1/90	<b>N1626</b>	295.0 x 75.0	<b>N1414</b>	295.0 x 60.0
BJ70, 75, FJ73, 75, 75 Disc/Drum	11/1984 - 1/90			<b>N1414</b>	295.0 x 60.0
RJ70, LJ70 2.4L Drum/Drum	11/1984 - 1/90	<b>N1625</b>	279.4 x 50.0	<b>N1492</b>	254.0 x 50.0
RJ70, LJ70 2.4L Disc/Drum	11/1984 - 1/90			<b>N1492</b>	254.0 x 50.0
HZJ70, 73, 75, PZJ70, 73, 75 Drum/Drum	1/1990 on	<b>N1626</b>	295.0 x 75.0	<b>N1414</b>	295.0 x 60.0
80 Series Handbrake	1/1990 - 8/92		<b>Handbrake</b>	<b>N3157</b>	210.0 x 35.0
FJ80, FZJ80, HDJ80, HZJ80 Disc/Drum	1/1990 on			<b>N1414</b>	295.0 x 60.0
KZJ70, KZJ77	1/1990 on			<b>N1660</b>	295.0 x 50.0
PJ70, PJ77, LJ77, LJ79	1/1990 - 5/93			<b>N1492</b>	254.0 x 50.0
PZJ70, 73, 75 Disc/Drum	1/1990 on			<b>N1414</b>	295.0 x 60.0
BJ73, HZJ70, HZJ73, HZJ75	1/1990 on			<b>N1414</b>	295.0 x 60.0
LJ70, LJ72, LJ73, KZJ73, RJ70, RJ73	1/1990 - 5/93			<b>N1492</b>	254.0 x 50.0
FJ, FZJ, HZJ70, 73, 75 Disc/Drum	1/1990 on			<b>N1414</b>	295.0 x 60.0
70 Series Handbrake	8/1992 on		<b>Handbrake</b>	<b>N3157</b>	210.0 x 35.0
80 & 100 Series Handbrake	8/1992 on		<b>Handbrake</b>	<b>N3158</b>	230.0 x 35.0
LJ70, LJ72, LJ73, KZJ73, RJ70, RJ73	5/1993 on			<b>N1660</b>	295.0 x 50.0
PJ70, PJ77, LJ77, LJ79	5/1993 on			<b>N1660</b>	295.0 x 50.0
GRJ200, UZJ200, VDJ200	9/07 on		<b>Handbrake</b>	<b>N3211</b>	241.0 x 30.7
VDJ70 Series	1/07 on			<b>N1414</b>	295.0 x 60.0

### Lexcen

Handbrake	1989 on		<b>Handbrake</b>	<b>N1669</b>	160.0 x 25.0
-----------	---------	--	------------------	--------------	--------------

### Lite Stout

All Models	1983 - 85	<b>N1070</b>	230.0 x 50.0	<b>N1070</b>	230.0 x 50.0
------------	-----------	--------------	--------------	--------------	--------------

### Liteace

KM20 With Dual Rear Wheels	1980 - 85	<b>N1450</b>	228.6 x 50.0	<b>N1640</b>	180.0 x 55.0
KM20 Disc/Drum	1980 - 82			<b>N1358</b>	228.6 x 40.0
KM20 With Single Rear Wheels	1980 - 81	<b>N1450</b>	228.6 x 50.0	<b>N1358</b>	228.6 x 40.0
CM20, YM21, YM30, YM35, YM40, YM41	1982 - 92			<b>N1358</b>	228.6 x 40.0
KR42	7/97 - 10/03			<b>N3178</b>	254.0 x 50.0

### Paseo

EL44	4/1991 on			<b>N3144</b>	180.0 x 25.0
------	-----------	--	--	--------------	--------------

### Prado

4 Cyl Disc/Drum	7/1996 on			<b>N1660</b>	295.0 x 50.0
KZJ, RZJ & VZJ90 Series Handbrake	1996 on		<b>Handbrake</b>	<b>N3157</b>	210.0 x 35.0

### Rav4

SXA10, SXA11	4/94 - 12/97			<b>N3160</b>	228.6 x 40.0
SXA10, SXA11 Handbrake	8/98 - 9/00		<b>Handbrake</b>	<b>N3199</b>	190.0 x 25.0
ACA21	5/00 on		<b>Handbrake</b>	<b>N3199</b>	190.0 x 25.0



## TOYOTA

### Seca

All Models	1986 - 9/94			<b>N1602</b>	200.0 x 30.0
All Models	9/1994 on			<b>N3123</b>	200.0 x 30.0

### Spacia

YR22	10/1993 on			<b>N1492</b>	254.0 x 50.0
SR40	1996 on			<b>N3178</b>	254.0 x 50.0

### Starlet

EP91	1/1996 on			<b>N3144</b>	180.0 x 25.0
------	-----------	--	--	--------------	--------------

### Stout

RK100, RK101	1964 - 72	<b>N1083</b>	290.0 x 55.0	<b>N1083</b>	290.0 x 55.0
RK101 Semi Floating Rear Axle	1972 - 79	<b>N1494</b>	290.0 x 60.0	<b>N1494</b>	290.0 x 60.0
RK101 Full Floating Rear Axle	1972 - 74	<b>N1494</b>	290.0 x 60.0	<b>N1083</b>	290.0 x 55.0
RK101 Full Floating Rear Axle	1974 - 79	<b>N1494</b>	290.0 x 60.0	<b>N1414</b>	295.0 x 60.0
RK101	1979 - 83	<b>N1495</b>	290.0 x 60.0	<b>N1495</b>	290.0 x 60.0

### T18

TE72 LIFTBACK	1979 - 83			<b>N1358</b>	228.6 x 40.0
---------------	-----------	--	--	--------------	--------------

### Tarago

YR21G, YR22G	1983 - 88			<b>N1492</b>	254.0 x 50.0
YR31 4WD	1986 - 89			<b>N1492</b>	254.0 x 50.0
TCR10, TCR20	5/90 - 2/93			<b>N1492</b>	254.0 x 50.0
TCR10, TCR11	1993 - 12/99		Handbrake	<b>N3199</b>	190.0 x 25.0
ACR30	2/00 on		Handbrake	<b>N3199</b>	190.0 x 25.0

### Tercel

AL20, AL21	1982 - 88			<b>N1620</b>	180.0 x 30.0
AL25	1983 - 88			<b>N1591</b>	200.0 x 30.0
EL40	1990 on			<b>N3144</b>	180.0 x 25.0

### Townace

KR42, SR40	7/97 - 10/03			<b>N3178</b>	254.0 x 50.0
------------	--------------	--	--	--------------	--------------

### Toyoace

PK30, PK31, PK40, PK41 1000-1250Kg	1962 - 67	<b>N1083</b>	290.0 x 55.0	<b>N1083</b>	290.0 x 55.0
RY16 Cab Chassis	1974 - 77	<b>N1496</b>	320.0 x 65.0	<b>N1496</b>	320.0 x 65.0
RY31 Cab Chassis	1980 - 83	<b>N1454</b>	295.0 x 75.0	<b>N1454</b>	295.0 x 75.0
Most Models Handbrake	1980 on		Handbrake	<b>N1541</b>	160.0 x 35.0
LY30 Cab Chassis	1982 - 83	<b>N1495</b>	290.0 x 60.0	<b>N1495</b>	290.0 x 60.0

### Yaris

NCP90, NCP91, NCP93	8/2005 on			<b>N3069</b>	200.0 x 30.0
---------------------	-----------	--	--	--------------	--------------



## TOYOTA

**N1025**

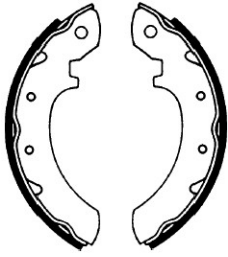

230.0 x 50.0

**N1028**

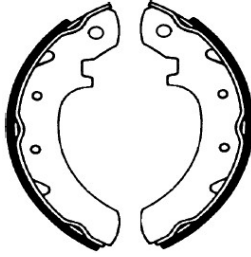

230.0 x 50.0

**N1033**

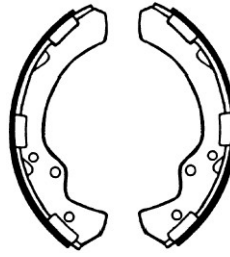

230.0 x 55.0

**N1034**

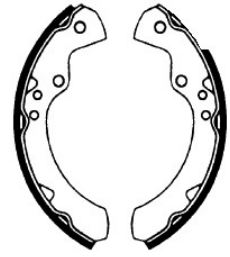

230.0 x 55.0

**N1044**

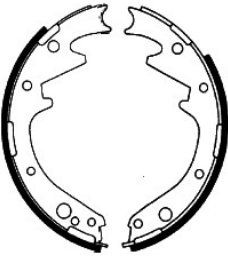

228.6 x 40.0

**N1054**

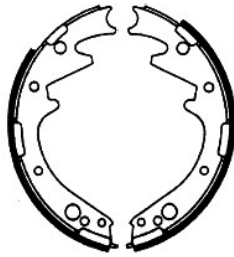

228.6 x 44.4

**N1062**

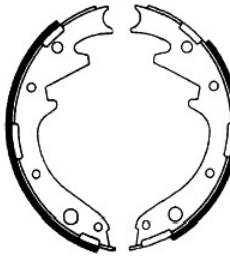

228.6 x 38.1

**N1065**

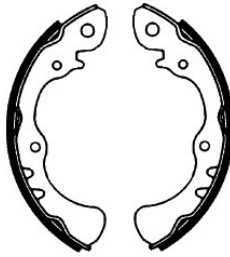

200.0 x 35.0

**N1066**

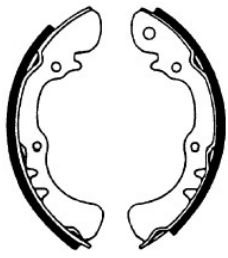

200.0 x 30.0

**N1070**

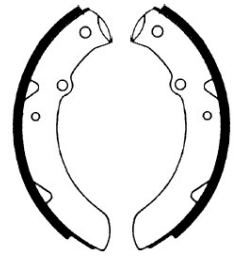

230.0 x 50.0

**N1072**

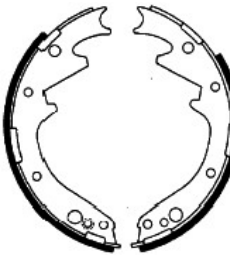

228.6 x 40.0

**N1083**

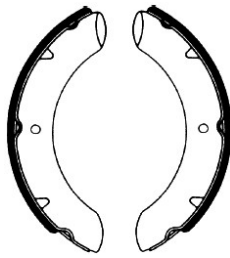

290.0 x 55.0

**N1179**

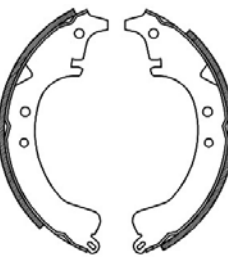

200.0 x 35.0

**N1182**

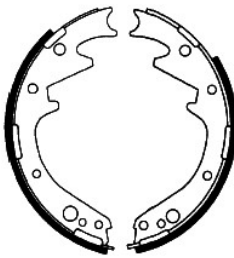

228.6 x 40.0

**N1189**

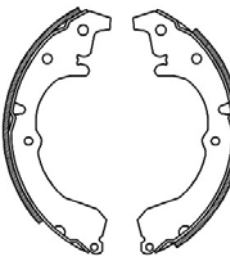

200.0 x 35.0

**N1190**

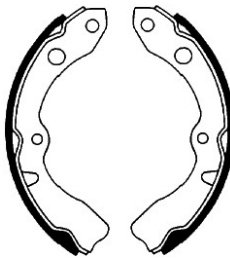

200.0 x 40.0





## TOYOTA

**N1356**

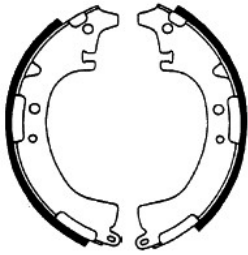

228.6 x 38.1

**N1358**

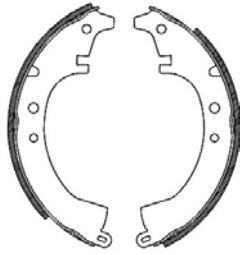

228.6 x 40.0

**N1371**

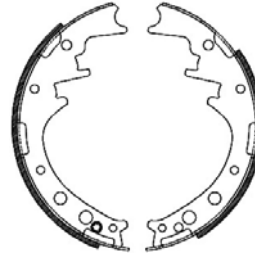

254.0 x 55.5

**N1375**

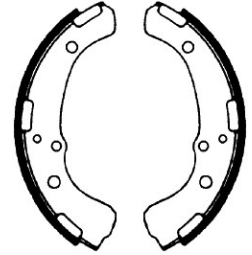

254.0 x 55.5

**N1376**

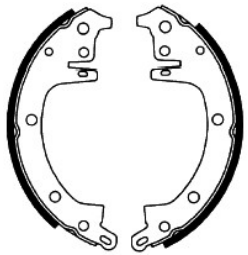

228.6 x 40.0

**N1388**

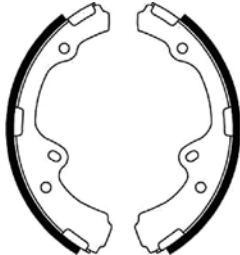

254.0 x 50.0

**N1396**

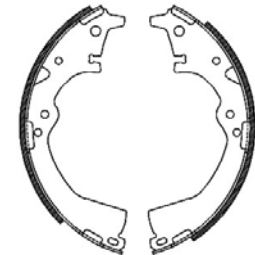

254.0 x 50.8

**N1405**

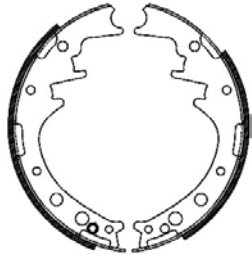

254.0 x 55.0

**N1407**

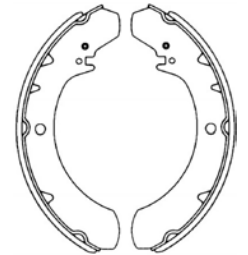

254.0 x 45.0

**N1414**

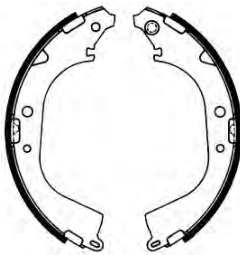

295.0 x 60.0

**N1415**

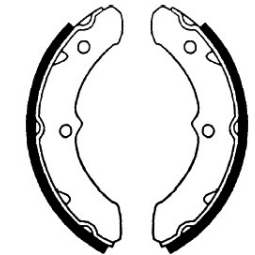

295.0 x 75.0

**N1448**

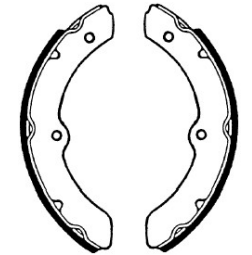

320.0 x 65.0

**N1449**

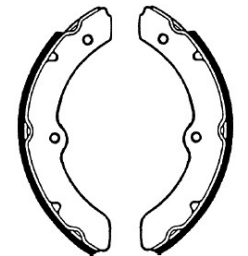

320.0 x 87.0

**N1450**

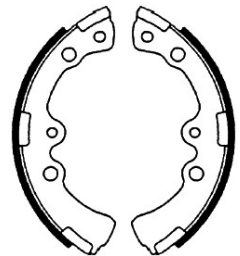

228.6 x 50.0

**N1454**

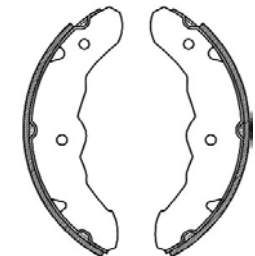

295.0 x 75.0

**N1490**

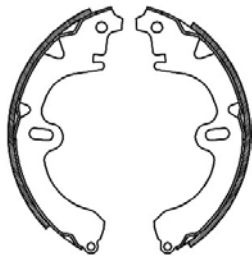

200.0 x 35.0



## TOYOTA

**N1492**

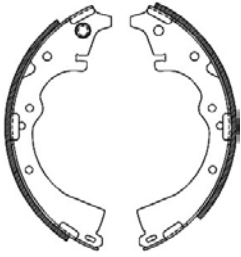

254.0 x 50.0

**N1493**

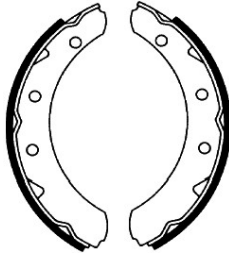

230.0 x 50.0

**N1494**

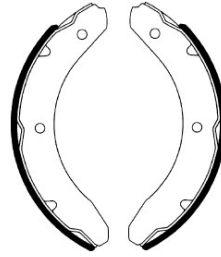

290.0 x 60.0

**N1495**

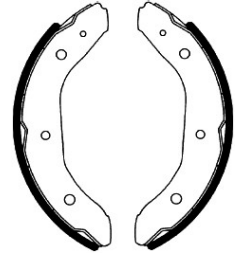

290.0 x 60.0

**N1496**

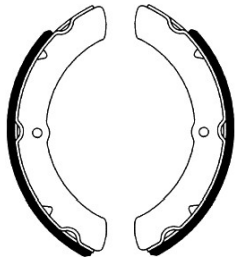

320.0 x 65.0

**N1497**

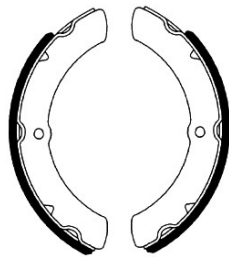

320.0 x 85.0

**N1499**

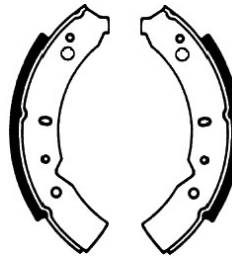

228.6 x 44.4

**N1540**

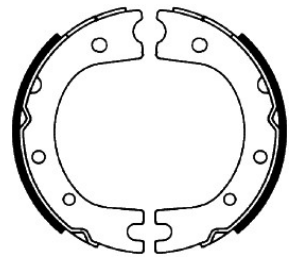

160.0 x 35.0

**N1541**

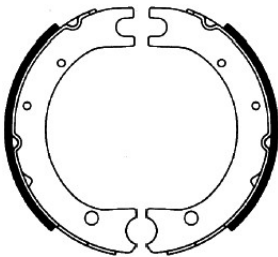

160.0 x 35.0

**N1542**

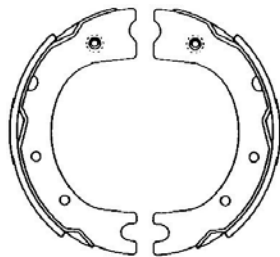

160.0 x 35.0

**N1543**

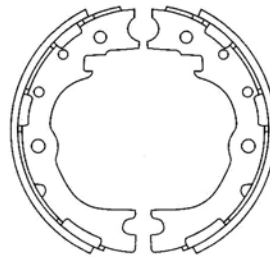

178.0 x 35.0

**N1591**

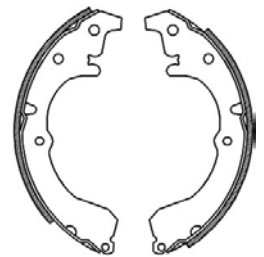

200.0 x 30.0

**N1620**

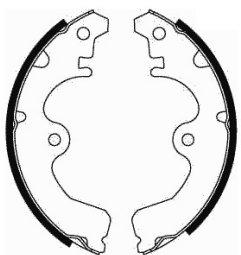

180.0 x 30.0

**N1622**

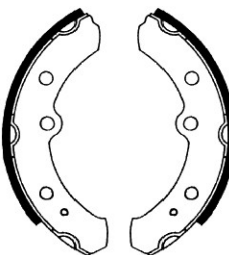

224.0 x 57.0

**N1623**

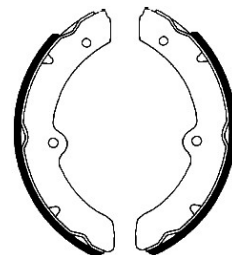

320.0 x 90.0

**N1625**

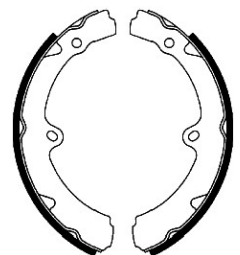

279.4 x 50.0



## TOYOTA

**N1626**

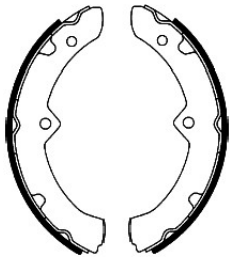

295.0 x 75.0

**N1629**

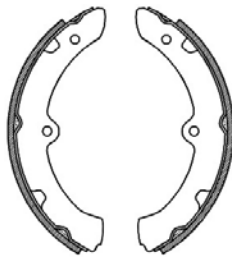

295.0 x 75.0

**N1631**

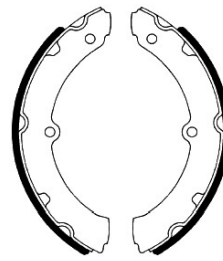

320.0 x 75.0

**N1635**

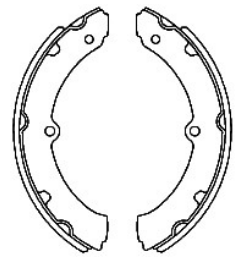

320.0 x 75.0

**N1640**

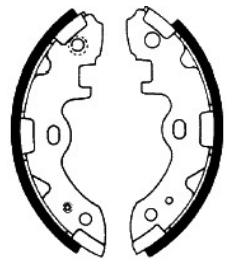

180.0 x 55.0

**N1645**

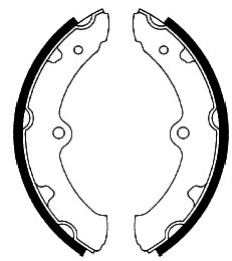

260.0 x 85.0

**N1646**

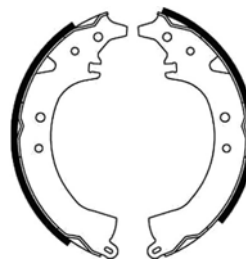

228.6 x 40.0

**N1647**

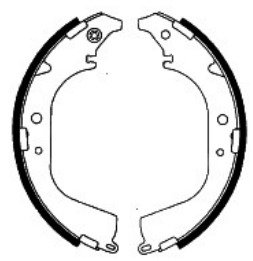

295.0 x 50.0

**N1659**

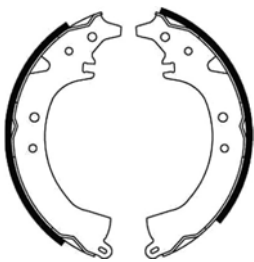

228.6 x 40.0

**N1660**

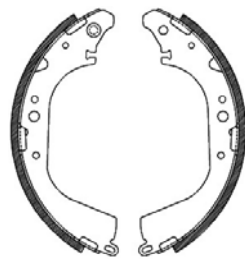

295.0 x 50.0

**N1669**

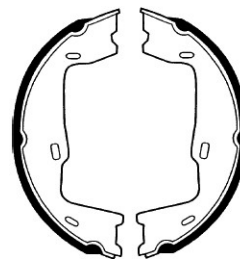

160.0 x 25.0

**N1678**

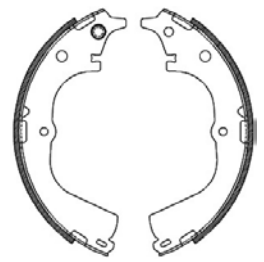

270.0 x 55.0

**N3042**

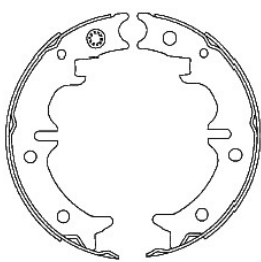

**N1752**  
170.0 x 30.0

**N3056**

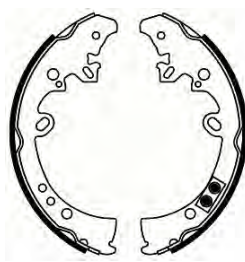

**N1832**  
295.0 x 61.4

**N3063**

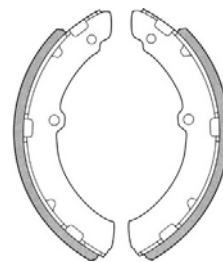

320.0 x 83.0

**N3064**

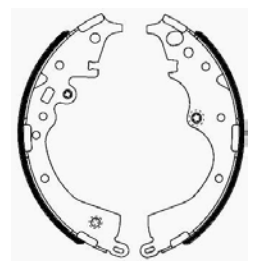

**N1847**  
254.0 x 50.0



## TOYOTA

**N3065**

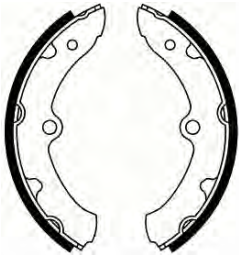

260.0 x 85.0

**N3069**

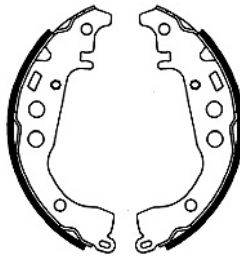

**N1852**  
200.0 x 30.0

**N3082**

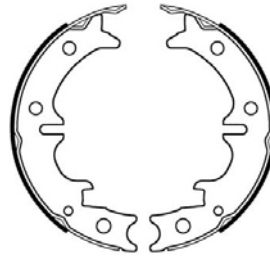

**N1839**  
175.0 x 30.0

**N3088**

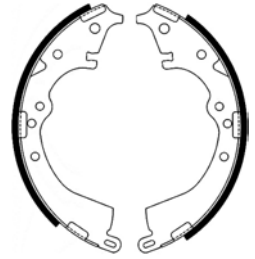

**BS5009**  
254.0 x 50.0

**N3112**

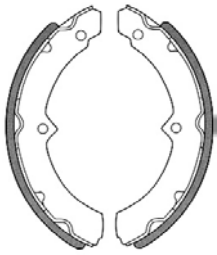

**N1693**  
320.0 x 75.0

**N3119**

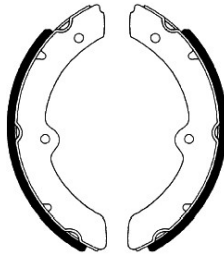

**N1700**  
320.0 x 75.0

**N3123**

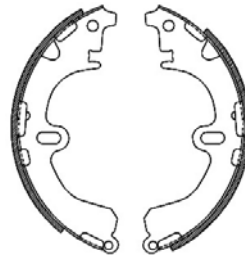

**N1704**  
200.0 x 30.0

**N3132**

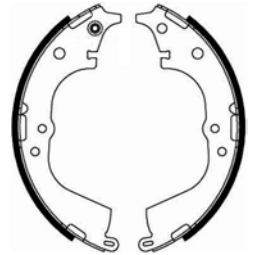

**N1714/BS5000**  
270.0 x 55.0

**N3144**

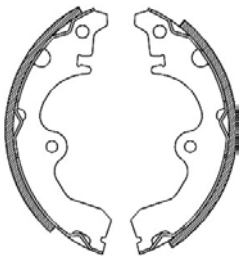

**N1731**  
180.0 x 25.0

**N3156**

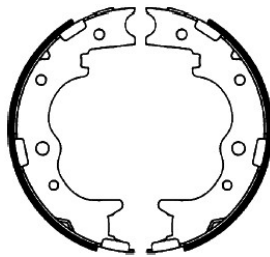

**N1743**  
200.0 x 45.0

**N3157**

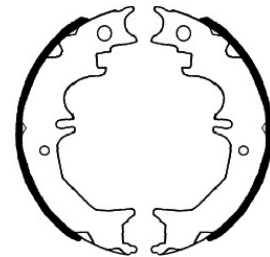

**N1744**  
210.0 x 35.0

**N3158**

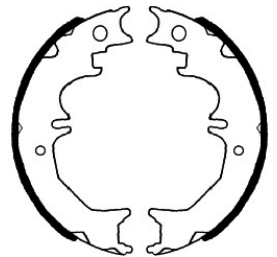

**N1745**  
230.0 x 35.0

**N3159**

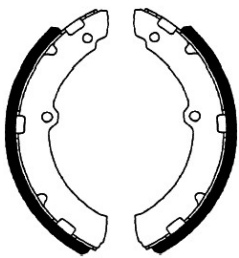

**N1746**  
320.0 x 83.0

**N3160**

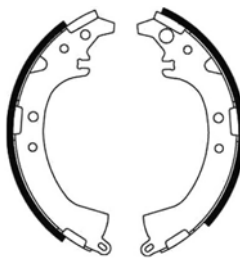

**N1747**  
228.6 x 40.0

**N3162**

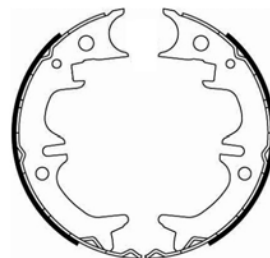

**N1751**  
170.0 x 30.0

**N3178**



**N1768**  
254.0 x 50.0





## TOYOTA

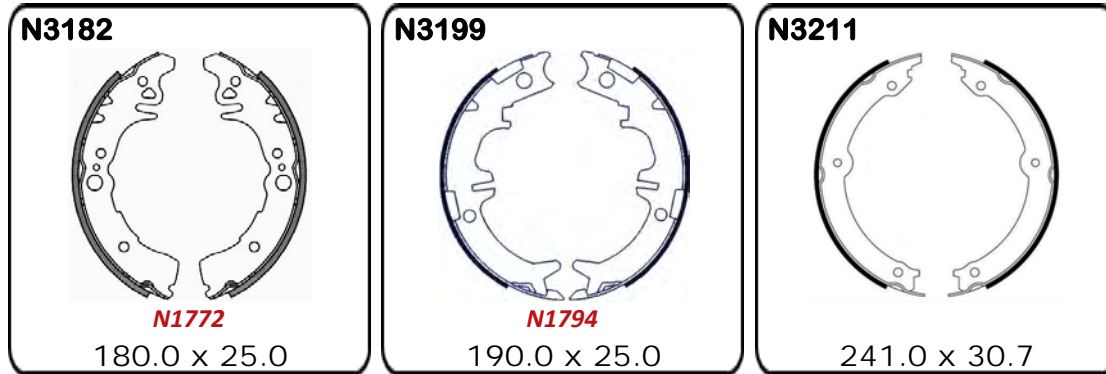

## TRAILER/CARAVAN

*Listed by Drum diameter - From the smallest*

Girlock - Mechanical				<b>N1423</b>	152.4 x 31.7
Girlock - Hydraulic				<b>N1332</b>	177.8 x 31.7
Girlock - Hydraulic				<b>N1087</b>	203.2 x 31.7
Girlock - Mechanical				<b>N1430</b>	203.2 x 31.7
Girlock - Mechanical				<b>N1431</b>	203.2 x 31.7
Girlock - Hydraulic				<b>N1022</b>	203.2 x 38.1
Girlock - Hydraulic				<b>N1384-1</b>	228.6 x 44.4
Girlock - Hydraulic				<b>N1002</b>	228.6 x 44.4
Girlock - Mechanical				<b>N1418</b>	228.6 x 44.4
Girlock - Mechanical				<b>N1419</b>	228.6 x 44.4
Girlock - Mechanical				<b>N1142</b>	228.6 x 44.4
Girlock - Mechanical				<b>N1298</b>	228.6 x 44.4
Other - Other Manufacturers				<b>N3161</b>	228.6 x 44.4
Other - Other Manufacturers				<b>N3044</b>	228.6 x 44.4
Other - Other Manufacturers				<b>N3043</b>	228.6 x 44.4
Girlock - Hydraulic				<b>N1264</b>	228.6 x 50.8
Girlock - Electrical				<b>N1439</b>	228.6 x 50.8
Girlock - Hydraulic				<b>N1271</b>	254.0 x 44.4
Girlock - Hydraulic & Mechanical				<b>N1424</b>	254.0 x 44.4
Girlock - Hydraulic & Mechanical				<b>N1425</b>	254.0 x 44.4
Girlock - Mechanical				<b>N1437</b>	254.0 x 44.4
Girlock - Electrical				<b>N1438</b>	254.0 x 57.1
Kelsey-Hayes - Electrical				<b>N1441</b>	254.0 x 57.1





## TRAILER/CARAVAN

*Listed by Drum diameter - From the smallest*

Kelsey-Hayes - Electrical				<b>N1442</b>	254.0 x 57.1
Girlock - Hydraulic				<b>N1436</b>	279.4 x 50.8
Girlock - Mechanical				<b>N1426</b>	279.4 x 50.8
Girlock - Hydraulic				<b>N1092</b>	279.4 x 57.1
Girlock - Hydraulic				<b>N1429</b>	279.4 x 57.1
Girlock - Hydraulic & Mechanical				<b>N1027</b>	279.4 x 57.1
Kelsey-Hayes - Electrical				<b>N1427</b>	304.8 x 50.8
Kelsey-Hayes - Electrical				<b>N1433</b>	304.8 x 50.8
Kelsey-Hayes - Electrical				<b>N1434</b>	304.8 x 50.8
Girlock - Hydraulic				<b>N1428</b>	304.8 x 57.1
Girlock - Hydraulic				<b>N1440</b>	304.8 x 57.1
Girlock - Mechanical				<b>N1435</b>	304.8 x 57.1
Girlock - Mechanical				<b>N1432</b>	314.0 x 88.9

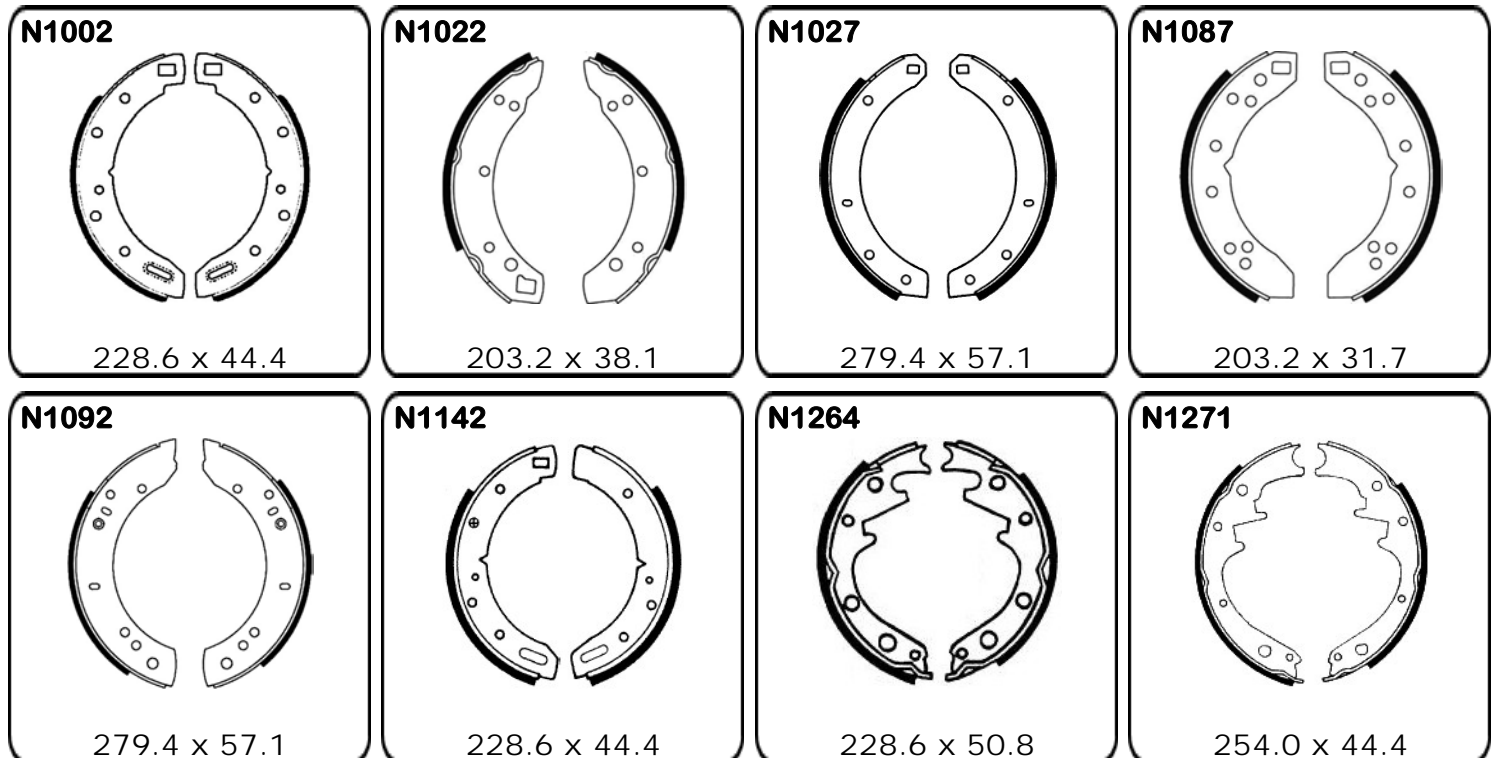



## TRAILER/CARAVAN

**N1298**

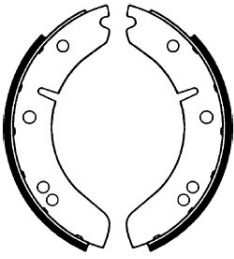

228.6 x 44.4

**N1332**

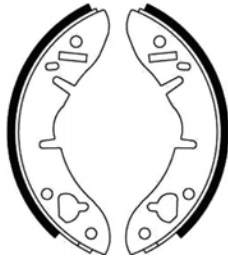

177.8 x 31.7

**N1384-1**

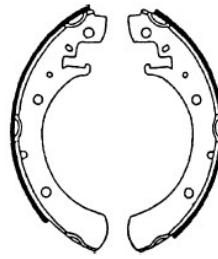

228.6 x 44.4

**N1418**

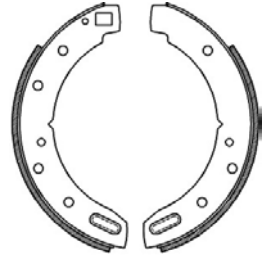

228.6 x 44.4

**N1419**

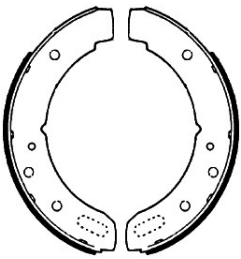

228.6 x 44.4

**N1423**

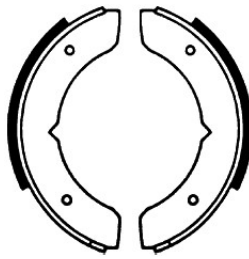

152.4 x 31.7

**N1424**

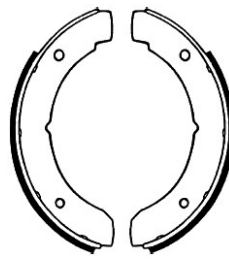

254.0 x 44.4

**N1425**

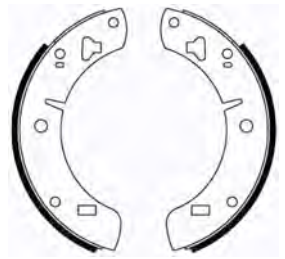

254.0 x 44.4

**N1426**

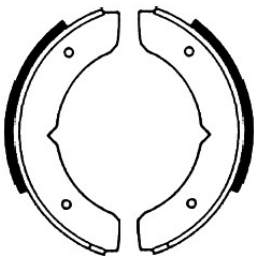

279.4 x 50.8

**N1427**

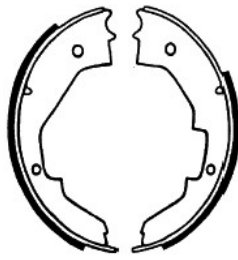

304.8 x 50.8

**N1428**

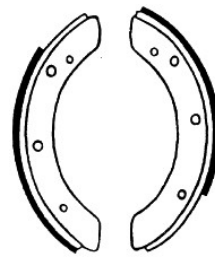

304.8 x 57.1

**N1429**

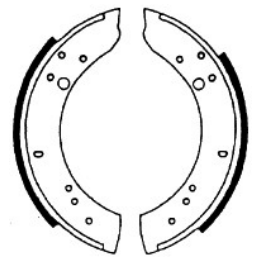

279.4 x 57.1

**N1430**

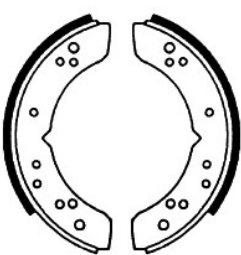

203.2 x 31.7

**N1431**

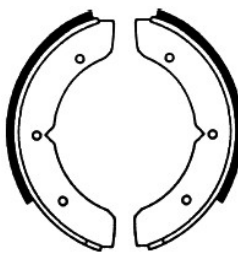

203.2 x 31.7

**N1432**

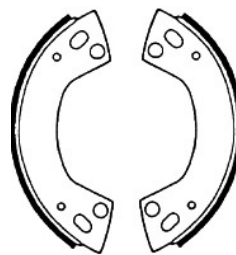

314.0 x 88.9

**N1433**



304.8 x 50.8

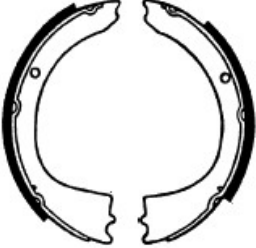
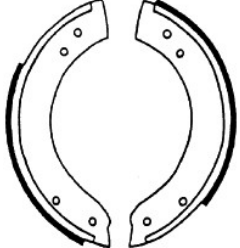
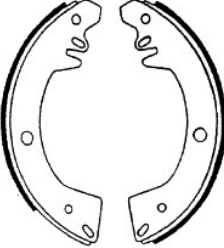
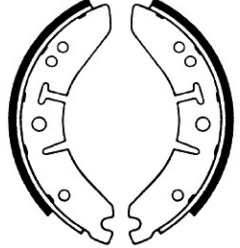
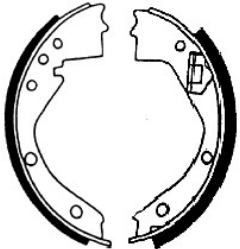
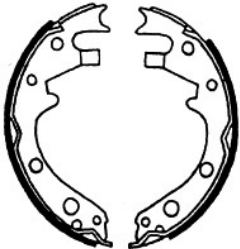
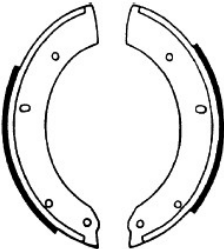
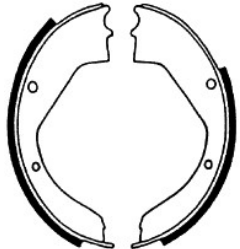
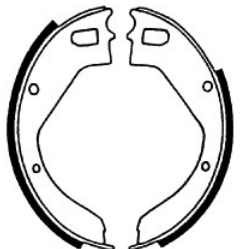
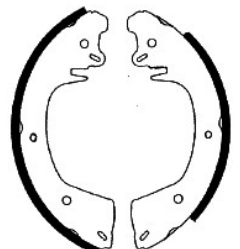
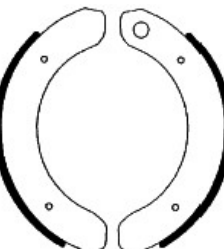
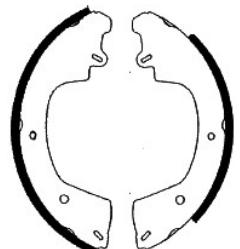

## TRAILER/CARAVAN

<p><b>N1434</b></p>  <p>304.8 x 50.8</p>	<p><b>N1435</b></p>  <p>304.8 x 57.1</p>	<p><b>N1436</b></p>  <p>279.4 x 50.8</p>	<p><b>N1437</b></p>  <p>254.0 x 44.4</p>
<p><b>N1438</b></p>  <p>254.0 x 57.1</p>	<p><b>N1439</b></p>  <p>228.6 x 50.8</p>	<p><b>N1440</b></p>  <p>304.8 x 57.1</p>	<p><b>N1441</b></p>  <p>254.0 x 57.1</p>
<p><b>N1442</b></p>  <p>254.0 x 57.1</p>	<p><b>N3043</b></p>  <p><b>N1749</b> 228.6 x 44.4</p>	<p><b>N3044</b></p>  <p><b>N1750</b> 228.6 x 44.4</p>	<p><b>N3161</b></p>  <p><b>N1748</b> 228.6 x 44.4</p>

## TRIUMPH

### 2.5 Series

MkI	1969 - 70		<b>N1006</b>	228.6 x 44.4
MkII	1970 - 76		<b>N1001</b>	228.6 x 44.4



## TRIUMPH

### 2000 Series

MkI	1964 - 70			<b>N1006</b>	228.6 x 44.4
MkII	1970 - 76			<b>N1001</b>	228.6 x 44.4

### 2500 Series

TC, TS Disc/Drum	1973 - 78			<b>N1001</b>	228.6 x 44.4
------------------	-----------	--	--	--------------	--------------

### Aclaim

Aclaim	10/1981 - 84			<b>N1393</b>	180.0 x 25.0
--------	--------------	--	--	--------------	--------------

### Dolomite

1.9L Sedan	1975 - 78			<b>N1022</b>	203.2 x 38.1
2.0L Sedan Sprint	1975 - 78			<b>N1169</b>	228.6 x 44.4

### GT6 Series

MkI, MkII, MkIII	1967 - 73			<b>N1087</b>	203.2 x 31.7
------------------	-----------	--	--	--------------	--------------

### Herald

All Drum/Drum Models	1959 - 64	<b>N1086</b>	203.2 x 31.7	<b>N1331</b>	177.8 x 31.7
All Disc/Drum Models	1963 - 66			<b>N1331</b>	177.8 x 31.7

### Mayflower

Mayflower	1950 - 51	<b>N1298</b>	228.6 x 44.4	<b>N1298</b>	228.6 x 44.4
Mayflower	1951 - 52	<b>N1230</b>	203.2 x 38.1	<b>N1230</b>	203.2 x 38.1

### Renown

Renown	1950 - 52	<b>N1298</b>	228.6 x 44.4	<b>N1298</b>	228.6 x 44.4
--------	-----------	--------------	--------------	--------------	--------------

### Spitfire

MkI, MkII, MkIII & MkIV	1963 - 73			<b>N1331</b>	177.8 x 31.7
-------------------------	-----------	--	--	--------------	--------------

### Stag

Sports & Hardtop	1972 - 78			<b>N1452</b>	228.6 x 57.1
------------------	-----------	--	--	--------------	--------------

### TR Series

TR2	1953 - 55	<b>N1285</b>	254.0 x 57.1	<b>N1298</b>	228.6 x 44.4
TR2	1954 - 55	<b>N1285</b>	254.0 x 57.1	<b>N1285</b>	254.0 x 57.1
TR3 to Chassis TS13045	1956 - 57	<b>N1285</b>	254.0 x 57.1	<b>N1285</b>	254.0 x 57.1
TR3, TR3A From Chassis TS56377	1959 - 62			<b>N1002</b>	228.6 x 44.4
TR4, TR4A, TR5, TR6 To Chassis CP76094	1961 - 72			<b>N1002</b>	228.6 x 44.4
TR6 from Chassis CP76095	4/72 - 75			<b>N1002</b>	228.6 x 44.4
TR7	1978 - 82			<b>N1498</b>	203.2 x 38.1



## TRIUMPH

**N1001**

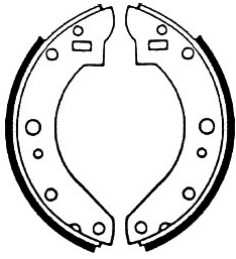

228.6 x 44.4

**N1002**

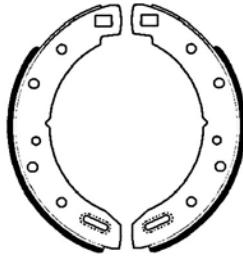

228.6 x 44.4

**N1006**

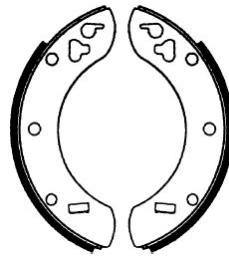

228.6 x 44.4

**N1022**



203.2 x 38.1

**N1086**

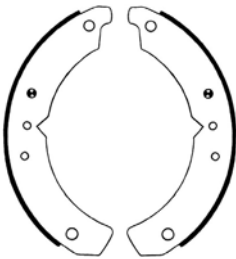

203.2 x 31.7

**N1087**

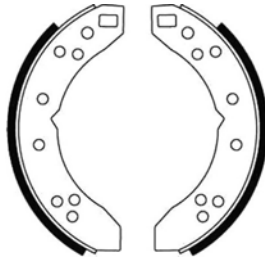

203.2 x 31.7

**N1169**

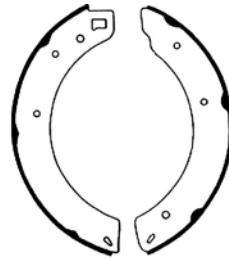

228.6 x 44.4

**N1230**

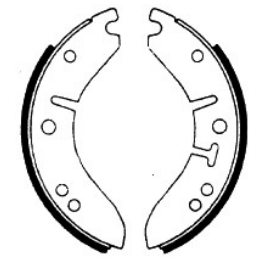

203.2 x 38.1

**N1285**

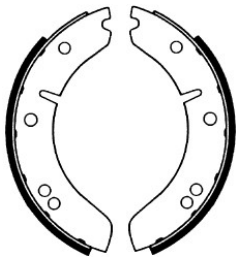

254.0 x 57.1

**N1298**

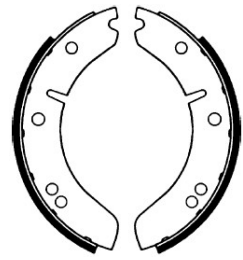

228.6 x 44.4

**N1331**

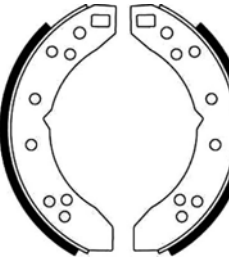

177.8 x 31.7

**N1393**

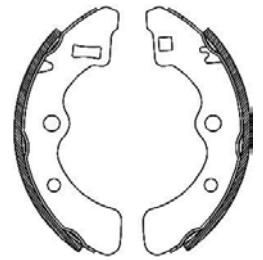

180.0 x 25.0

**N1452**

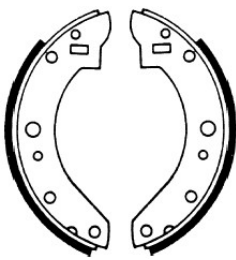

228.6 x 57.1

**N1498**

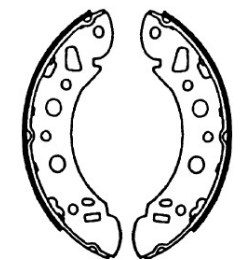

203.2 x 38.1





## VAUXHALL

### Velox & Cresta

PA 2.3L, P	1958 - 61	<b>N1272</b>	228.6 x 57.1	<b>N1273</b>	228.6 x 44.4
PA 2.3L, P	1961 - 63	<b>N1278</b>	254.0 x 57.1	<b>N1273</b>	228.6 x 44.4
PB 2.7L	1963 - 66			<b>N1273</b>	228.6 x 44.4

### Victor

FD I, FD II	1957 - 60	<b>N1230</b>	203.2 x 38.1	<b>N1231</b>	203.2 x 38.1
FB 1.6L From Chassis 1001 to 42843	1961 - 62	<b>N1242</b>	228.6 x 44.4	<b>N1244</b>	203.2 x 38.1
FB 1.6L From Chassis 42844	1963 - 63	<b>N1244</b>	203.2 x 38.1	<b>N1244</b>	203.2 x 38.1
Super FB 1.6L Cha. 4250001 to 4289073	1963	<b>N1580</b>	228.6 x 44.4	<b>N1244</b>	203.2 x 38.1
Super FB 1.6L From Chassis 4289074	1963 - 64	<b>N1581</b>	228.6 x 44.4	<b>N1244</b>	203.2 x 38.1
FC101	1964 - 67	<b>N1499</b>	228.6 x 44.4	<b>N1500</b>	228.6 x 44.4

### Viva

HA, HB	1964 - 67	<b>N1259</b>	203.2 x 31.7	<b>N1259</b>	203.2 x 31.7
--------	-----------	--------------	--------------	--------------	--------------

### VX4/90

1.5L, FB, FC 1.6L	1962 - 64			<b>N1244</b>	203.2 x 38.1
FCH From Chassis 4289074	1964 - 67			<b>N1500</b>	228.6 x 44.4

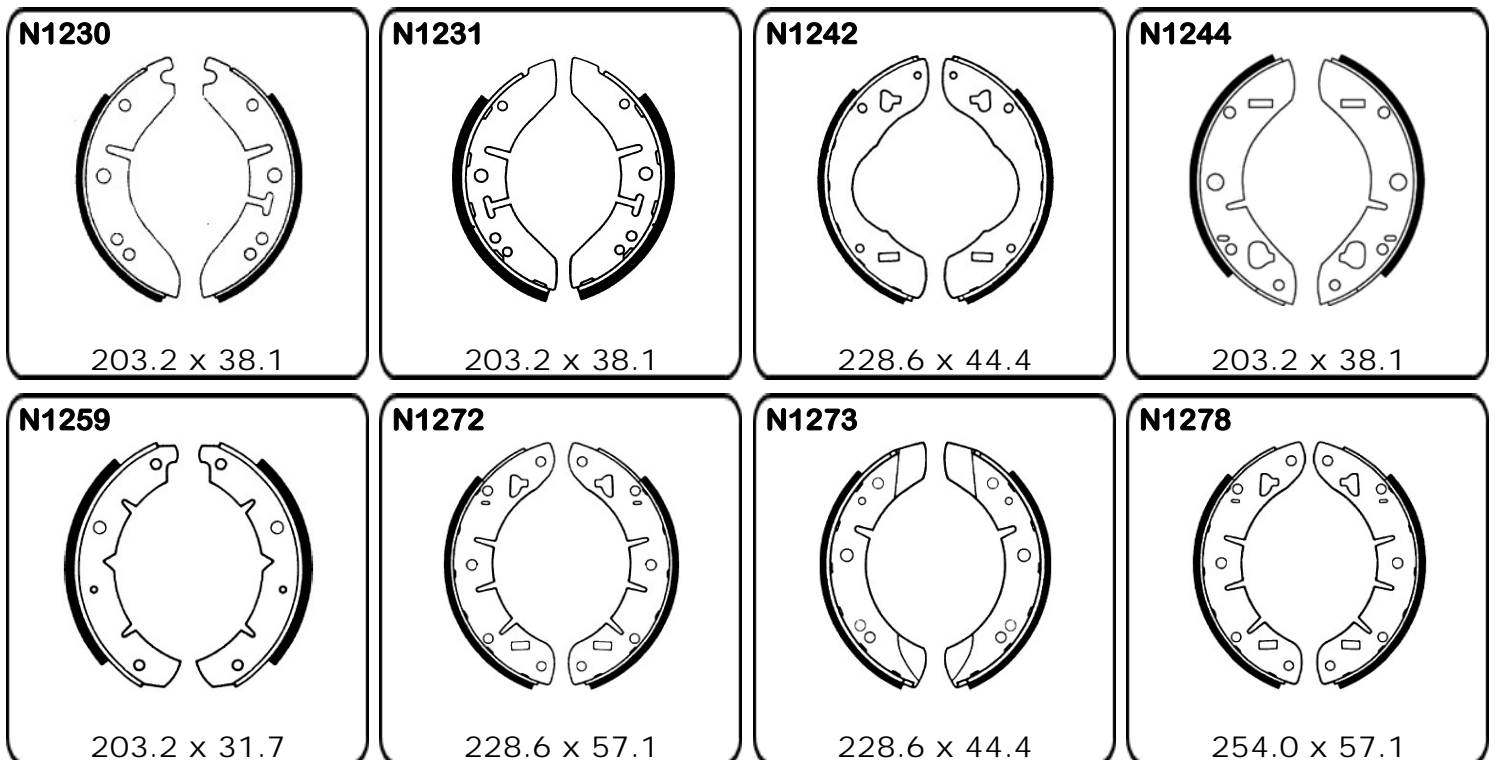



## VAUXHALL

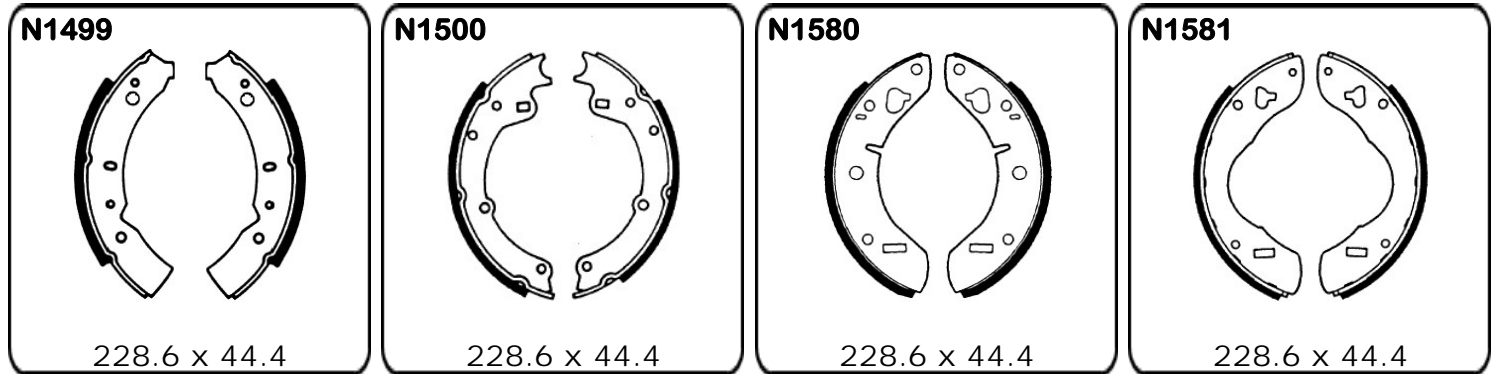

## VOLKSWAGEN

### 1200

Sedan From Chassis 157415 to 1673410	1954 - 57	<b>N1299</b>	230.0 x 30.0	<b>N1299</b>	230.0 x 30.0
Sedan From Chassis 1673411	1957 - 64	<b>N1300</b>	230.0 x 40.0	<b>N1301</b>	230.0 x 30.0
Sedan	1964 - 67	<b>N1334</b>	230.0 x 40.0	<b>N1335</b>	230.0 x 30.0
Country Buggy	1968 - 70	<b>N1205</b>	250.0 x 55.0	<b>N1206</b>	250.0 x 45.0

### 1300

Sedan	1966 - 75	<b>N1334</b>	230.0 x 40.0	<b>N1335</b>	230.0 x 30.0
Country Buggy	1968 - 70	<b>N1205</b>	250.0 x 55.0	<b>N1206</b>	250.0 x 45.0

### 1500

Sedan & Wagon To Chassis 76298	1962 - 63	<b>N1305</b>	230.0 x 50.0	<b>N1306</b>	230.0 x 45.0
Sedan & Wagon From Chassis 76299	11/1963 - 68	<b>N1209</b>	248.0 x 50.0	<b>N1210</b>	248.0 x 45.0
400 Kg Panel Van	1965 - 67	<b>N1205</b>	250.0 x 55.0	<b>N1210</b>	248.0 x 45.0
Sedan	1968 - 71			<b>N1362</b>	230.0 x 40.0

### 1600

Fastback, Sedan & Wagon	1967 - 68	<b>N1209</b>	248.0 x 50.0	<b>N1210</b>	248.0 x 45.0
Fastback, Sedan & Wagon	1968 - 73			<b>N1210</b>	248.0 x 45.0
Sedan & Superbug	1970 - 76			<b>N1362</b>	230.0 x 40.0

### Caravelle

2.0 GL	1986 on			<b>N1654</b>	252.0 x 56.0
--------	---------	--	--	--------------	--------------

### Commerical Models

From Chassis No 20-117902 to 1144281	1955 - 62	<b>N1313</b>	230.0 x 50.0	<b>N1314</b>	230.0 x 40.0
From Chassis 1144282	8/63 - 1970	<b>N1205</b>	250.0 x 55.0	<b>N1206</b>	250.0 x 45.0
1600	8/70 - 1971			<b>N1372</b>	252.0 x 55.0



## VOLKSWAGEN

### Commerical Models

1600, 1700	8/71 - 2/74			<b>N1373</b>	252.0 x 55.0
1700, 1600, 1800, 2000	2/74 - 80			<b>N1377</b>	252.0 x 55.0

### Golf

1.5L, 1.6L Petrol & Diesel	1974 - 7/78			<b>N1369</b>	180.0 x 30.0
1.1, 1.3, 1.5, 1.6L & Diesel	8/1978 - 8/91			<b>N3125</b>	180.0 x 31.0
All Disc/Drum Models	1991 - 99			<b>N3154</b>	200.0 x 40.0

### Karman Ghia

1500S	1960 - 65	<b>N1209</b>	248.0 x 50.0	<b>N1210</b>	248.0 x 45.0
1200	1963 - 64	<b>N1205</b>	250.0 x 55.0	<b>N1206</b>	250.0 x 45.0
1200	8/64 - 65	<b>N1334</b>	230.0 x 40.0	<b>N1335</b>	230.0 x 30.0
1600, 1600L	1966 - 71			<b>N1210</b>	248.0 x 45.0

### Kombi

Van	1979 - 87			<b>N1377</b>	252.0 x 55.0
Van	1988 - 92			<b>N1654</b>	252.0 x 56.0

### Passat

1300 Automatic & 1.6L GLS, LS, S & TS	1973 - 10/79			<b>N1363</b>	200.0 x 30.0
1300 Manual	1973 - 7/78			<b>N1369</b>	180.0 x 30.0
1.3 & 1.5D, 1.6D & 1.8L	8/1978 - 12/83			<b>N3125</b>	180.0 x 31.0
1.9L CLS & GLS	1981 - 83			<b>N3154</b>	200.0 x 40.0
1.6T & TD, 1.6 & 1.8L C, CL, GL	1984 - 4/89			<b>N3125</b>	180.0 x 31.0
2.0L CLS & GLS	1984 - 4/89			<b>N3154</b>	200.0 x 40.0

### Polo

With ATE Rear Brakes	1996 - 99			<b>N3094</b>	200.0 x 40.0
----------------------	-----------	--	--	--------------	--------------

### Transporter

T2	1980 - 7/82			<b>N1377</b>	252.0 x 55.0
T3	8/82 - 8/90			<b>N1654</b>	252.0 x 56.0
T4	9/1990 on			<b>N3130</b>	270.0 x 55.0

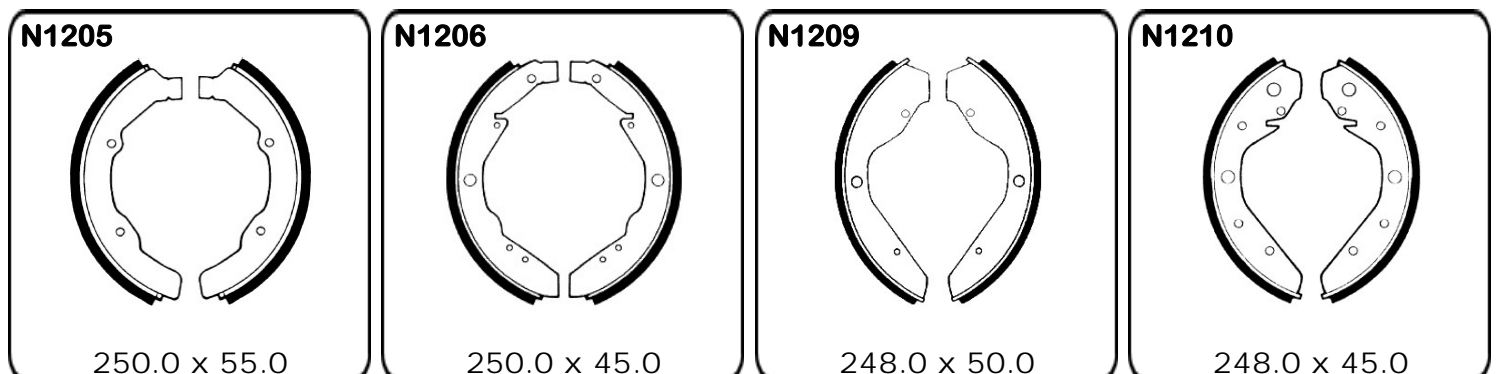



## VOLKSWAGEN

**N1299**

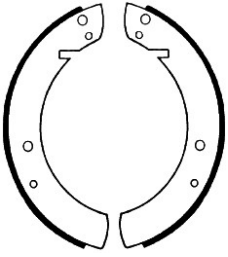

230.0 x 30.0

**N1300**

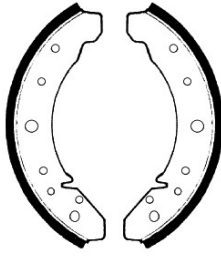

230.0 x 40.0

**N1301**

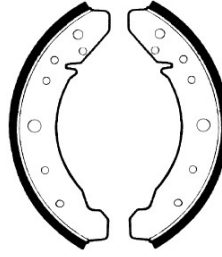

230.0 x 30.0

**N1305**

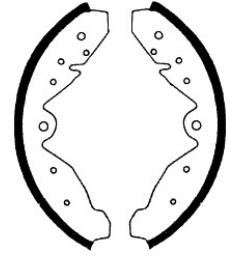

230.0 x 50.0

**N1306**

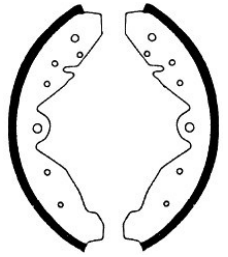

230.0 x 45.0

**N1313**

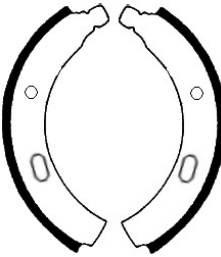

230.0 x 50.0

**N1314**

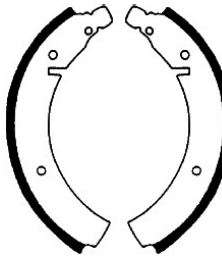

230.0 x 40.0

**N1334**

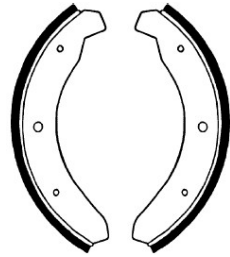

230.0 x 40.0

**N1335**

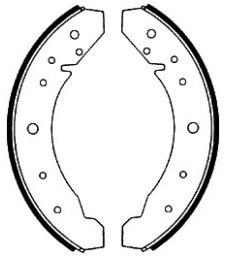

230.0 x 30.0

**N1362**

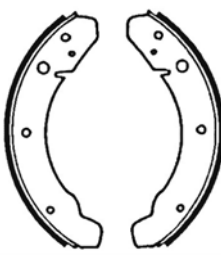

230.0 x 40.0

**N1363**

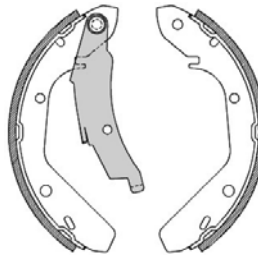

200.0 x 30.0

**N1369**

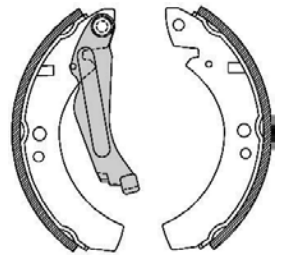

180.0 x 30.0

**N1372**

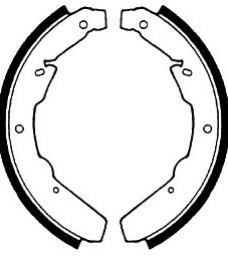

252.0 x 55.0

**N1373**

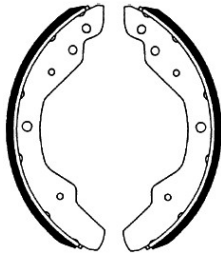

252.0 x 55.0

**N1377**

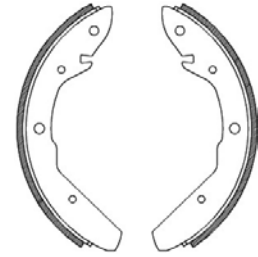

252.0 x 55.0

**N1654**

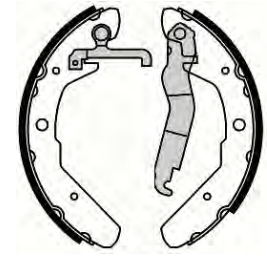

252.0 x 56.0



## VOLKSWAGEN

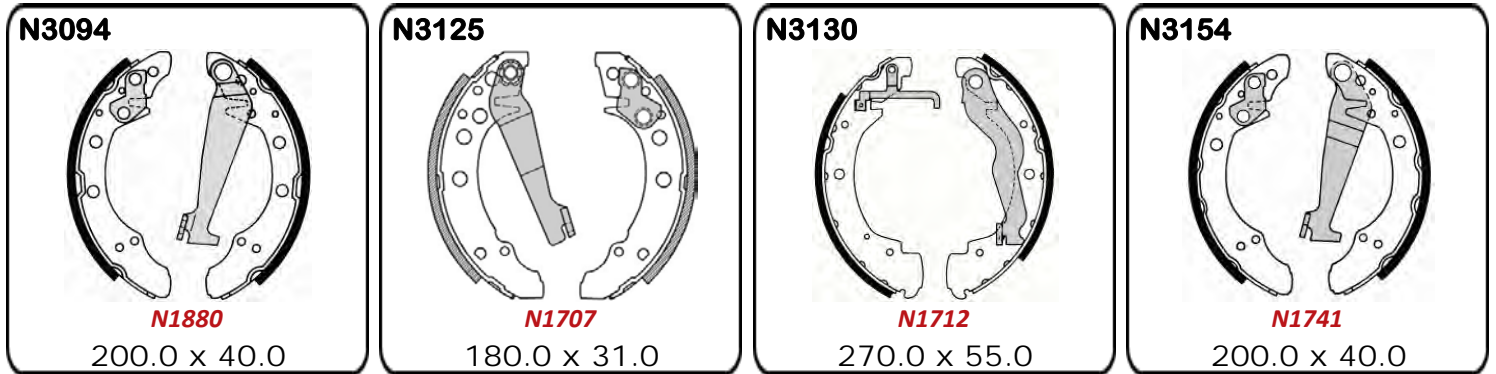

## VOLVO

### 122

All Models	1961 - 70			<b>N1501</b>	228.6 x 50.8
------------	-----------	--	--	--------------	--------------

### 2 Series

240, 242, 244, 245, 262, 264, 265 Handbrake Most			<b>Handbrake</b>	<b>N3202</b>	160.0 x 25.0
--	--	--	------------------	--------------	--------------

### 7 Series

740, 760, 780 Handbrake			<b>Handbrake</b>	<b>N3202</b>	160.0 x 25.0
-------------------------	--	--	------------------	--------------	--------------

### 9 Series

940, 960 Handbrake			<b>Handbrake</b>	<b>N3202</b>	160.0 x 25.0
--------------------	--	--	------------------	--------------	--------------

### P1800

Sports Coupe	1960 - 62			<b>N1505</b>	228.6 x 50.8
Sports Coupe	8/1962 - 64			<b>N1501</b>	228.6 x 50.8
S Sports Coupe	6/1964 - 68			<b>N1505</b>	228.6 x 50.8
S Sports Coupe	9/1968 - 70			<b>N1501</b>	228.6 x 50.8

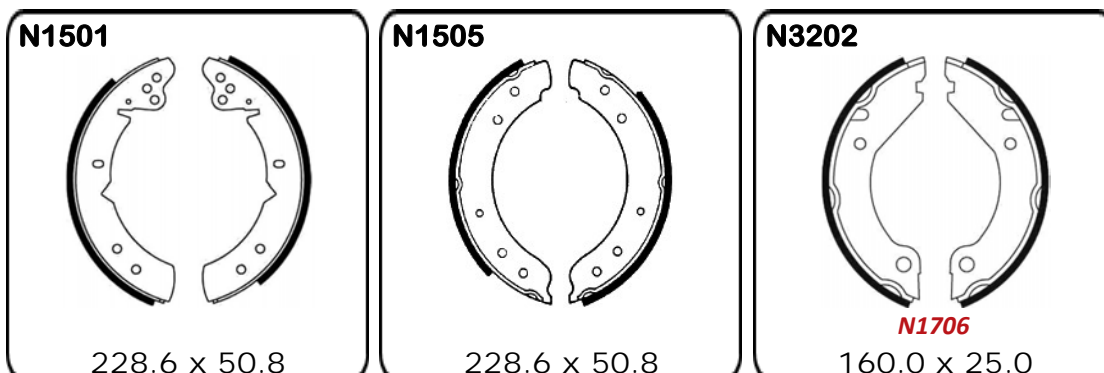





## WOLSELEY

### 4/44 & 4/50

4/44, 4/50	1949 - 56	<b>N1234</b>	228.6 x 38.1	<b>N1234</b>	228.6 x 38.1
------------	-----------	--------------	--------------	--------------	--------------

### 6/80

6/80	1949 - 53	<b>N1325</b>	254.0 x 44.4	<b>N1325</b>	254.0 x 44.4
------	-----------	--------------	--------------	--------------	--------------

### 6/90

MkI & MkII	1955 - 57	<b>N1502</b>	279.4 x 57.1	<b>N1502</b>	279.4 x 57.1
MkIII	1958 - 59	<b>N1504</b>	282.5 x 69.8	<b>N1503</b>	279.4 x 53.9

### 6/99 & 6/110

MkI & MkII	1959 - 66			<b>N1458</b>	254.0 x 76.2
------------	-----------	--	--	--------------	--------------

### 15/60 & 24/80

MkI & MkII	1959 - 66	<b>N1145</b>	228.6 x 63.5	<b>N1002</b>	228.6 x 44.4
------------	-----------	--------------	--------------	--------------	--------------

### 1500

1500	1958 - 59	<b>N1234</b>	228.6 x 38.1	<b>N1230</b>	203.2 x 38.1
------	-----------	--------------	--------------	--------------	--------------

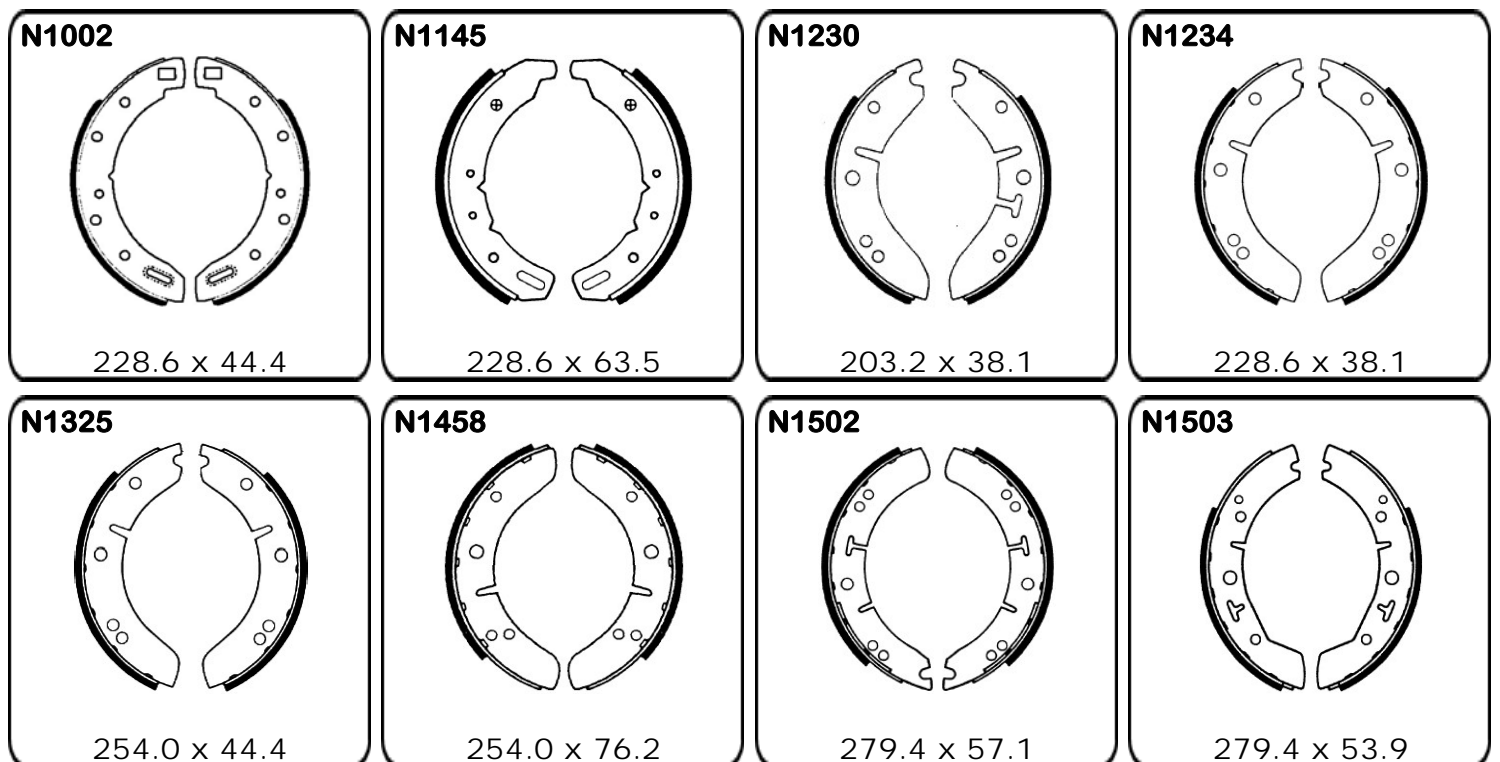



## WOLSELEY

---

**N1504**

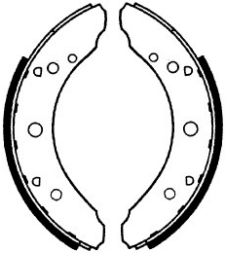

282.5 x 69.8